

Williams®

16P-485-100
Game No. 485
October, 1978

PHOENIX

SOLID STATE

CMOS RAM PROTECT
CIRCUITRY INSTALLED
2/24/82 MRY

L1 }
C66 } IN
D19 }
10K }
R30 }
R40 } OUT
C27 }

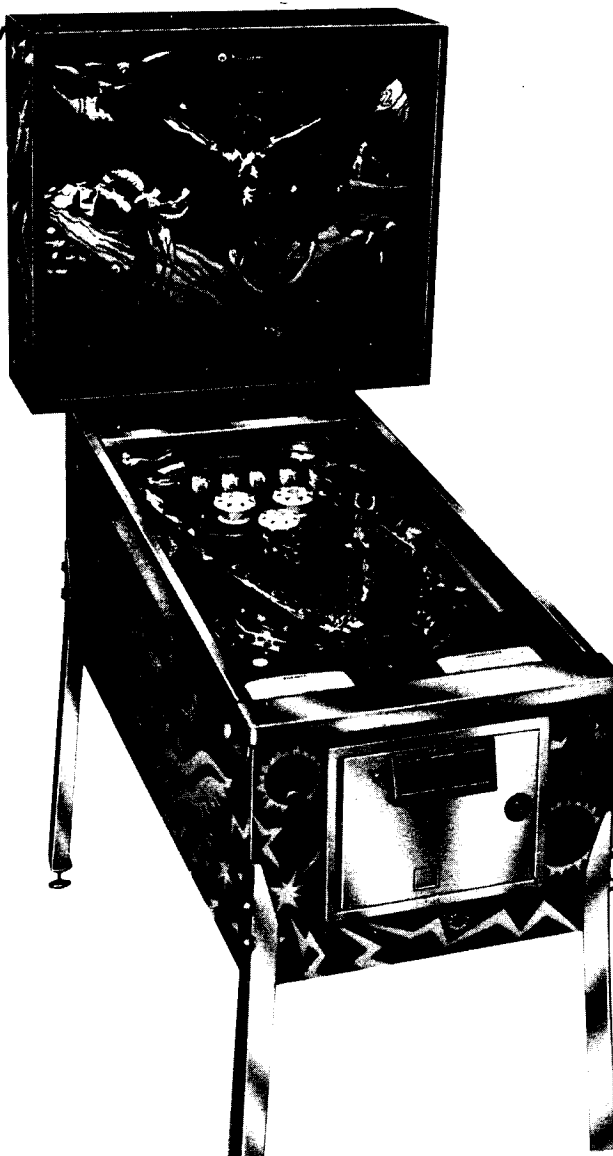

(312) 267-2240
For service call Toll-Free
800-621-4765
In Illinois call
800-972-7898



Williams®
ELECTRONICS, INC.

An Xcor International Inc. Company
3401 N. California Ave., Chicago, IL 60618
Cable Address: WILCOIN, CHICAGO

CONTENTS

Section	Page
1. INSTALLATION	2
2. GAME OPERATION	5
3. GAME ADJUSTMENTS	5
Replays	6
Maximum Credits	6
Match/Credit/Extra Ball/Special	6
Play	10
High Score Credits	10
Play Adjustment	10
Maximum Tilts	10
Credits in Game	11
High Score to Date	11
Game Pricing	11
4. GAME BOOKKEEPING	14
5. BUILT-IN DIAGNOSTICS	16
6. TROUBLESHOOTING CHARTS	21
7. INTERCONNECTION CHARTS	24
8. MECHANICAL ADJUSTMENTS	35
9. SPARE PARTS	35
<i>Schematics and Assembly Drawings</i>	<i>Insert</i>

SECTION 1 INSTALLATION

The initial set up and assembly of a solid state pinball is identical to mechanical pinballs.

First, remove the backbox and cabinet from the shipping carton. Set up the cabinet and mount the legs. Reach into the large hole in the backbox and pull out the power cord and place it in the slot provided. **Do not plug machine in at this time.**

Next, remove the red shipping block from insert door and place the assembled backbox on the pedestal. Do not pull up any of the other cables from the cabinet at this time.

Note that the backbox has a metal bracket protruding from the square bottom hole. This bracket engages a similar bracket on the cabinet pedestal to prevent the backbox from tipping forward while the insert door is open.

Open the insert door by lifting the door latch (located at right) up. Install the backbox mounting bolts securely. Level the machine from side to side and front to back by adjusting the leg levelers.

There are seven harnesses that must be interconnected next. Four of the harnesses are from the playfield and three are from the cabinet. The connectors are size and color coded and mate wires of the same color together, except in the case of the power line to the transformer connector, where the colors do not match. Connect the black plug to the black connector first. Then interconnect the remaining seven connectors. **DO NOT** intermix the white connector and black plug even though they are the same size.

Next, connect the braided ground strap to the backbox shield liner by fastening it under the wing nut located just in front of the rectangular bottom hole in the backbox.

Then check the connectors to make sure that none of the wire terminations have come loose or were pushed out. Reseat any loose wires by pushing in on the wire terminations.

Also push on all the connectors that are attached to the CPU Board (Figure 1 — No. 1) to make sure they are firmly seated. Then push on all the connectors that are attached to the Driver Board (Figure 1 — No. 2) to make sure they are firmly seated. Also push on all the connectors that are attached to the Power Supply Board (Figure 1 — No. 3). Then check the connectors on both bridge rectifiers (Figure 1 — No. 5) and the filter capacitor (Figure 1 — No. 6).

Also check and push on all the connectors that are attached to the Master Display Board (Figure 1 — No. 12) and the connectors that leave the Master Display Board and go off to the four individual player displays (Figure 1 — No. 8, 9, 10, 11). Now check the connectors on the Sound Board in the cabinet.

Finally, check and push on the connectors which interconnects the coin door mechanism to the cabinet harness.

After all the connectors have been checked as outlined above, gently press on the integrated circuit (IC) packages that are socketed on the CPU and Sound Boards (Figures 2 and 3). **DO NOT** remove any of the IC packages from their sockets. Also check that the batteries are still securely mounted to the CPU Board. **DO NOT REMOVE THE BATTERIES!** If the batteries are removed with power off the game will go to factory settings for all the options and particular changes will have to be restored manually before the game can be put on location. The batteries are all installed with the positive (+) end up. Battery life is about the same as shelf life or about one year. When it is time to replace the batteries, remove the batteries while the game is ON or the game will go to factory settings.

Check that all cables are clear of moving parts. Check for any wires that may have come disconnected. Check switches for loose solder or other foreign material that may have come loose in shipment. Check wires on coils for proper soldering. Check that fuses on the Power Supply Board are secure. Check adjustment of the four tilt switches: Playfield Shake on bottom of playfield, Super Slam on front door, Plumb bob tilt on left side of cabinet near front door and Ball Roll tilt above the Plumb bob. Refer to Section 8 for specific mechanical adjustments for each of these tilt switches.

Before plugging the machine in also check that the AC line fuse is secure in its holder. Install the ball in the roll tilt, if not already installed.

This machine **MUST BE PLUGGED INTO A PROPERLY GROUNDED OUTLET TO PREVENT SHOCK HAZARD** and to insure PROPER GAME OPERATION. **DO NOT** use a "cheater plug" to defeat the ground pin. **DO NOT** cut off the ground pin. The line voltage **MUST** agree with that on the shipping carton or serious damage to the machine will occur when it is plugged in.

The game is now ready to plug in and check out. Lower the playfield and close the insert door. Plug the game in

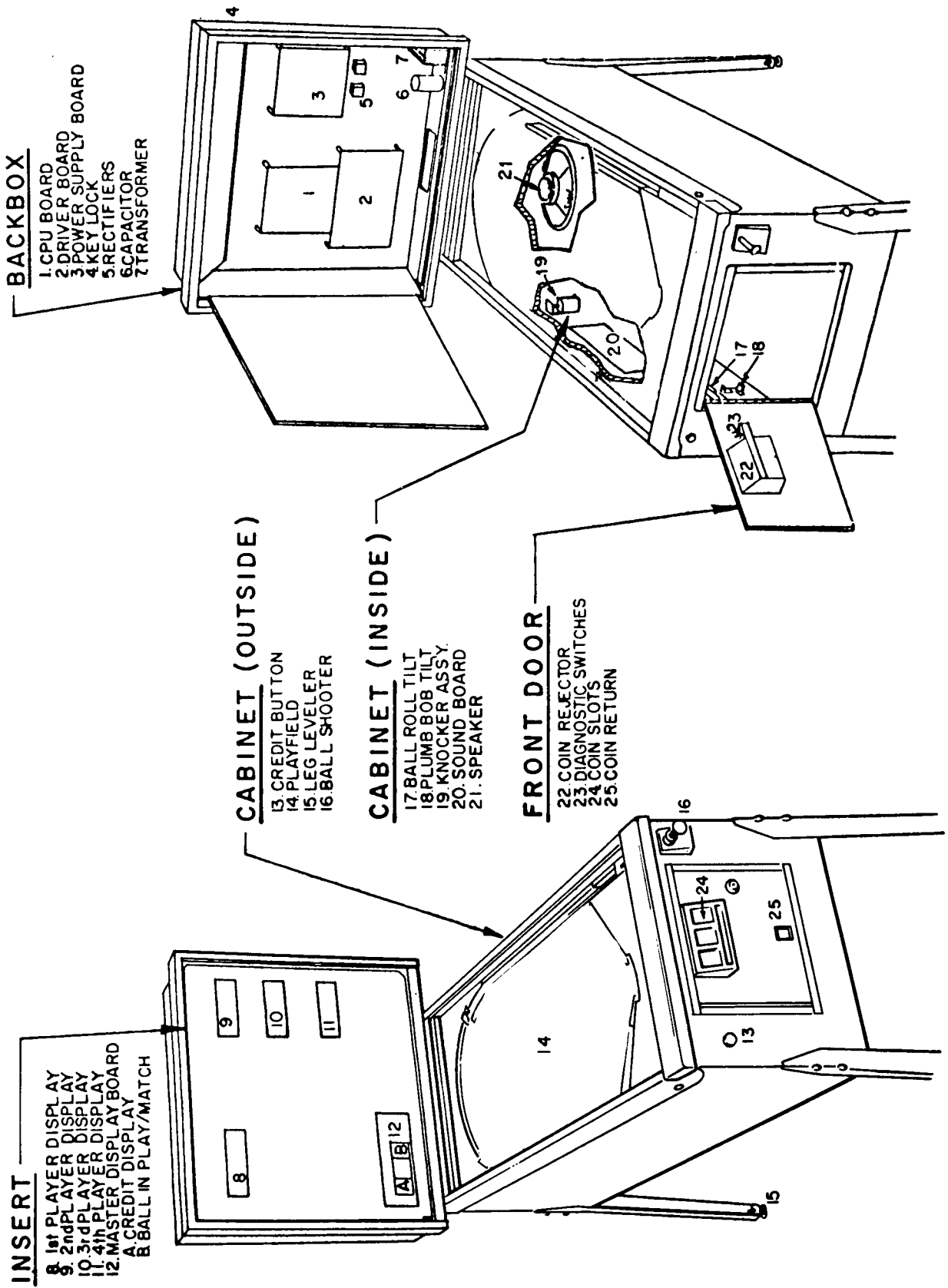

Figure 1. Location of Major Assemblies

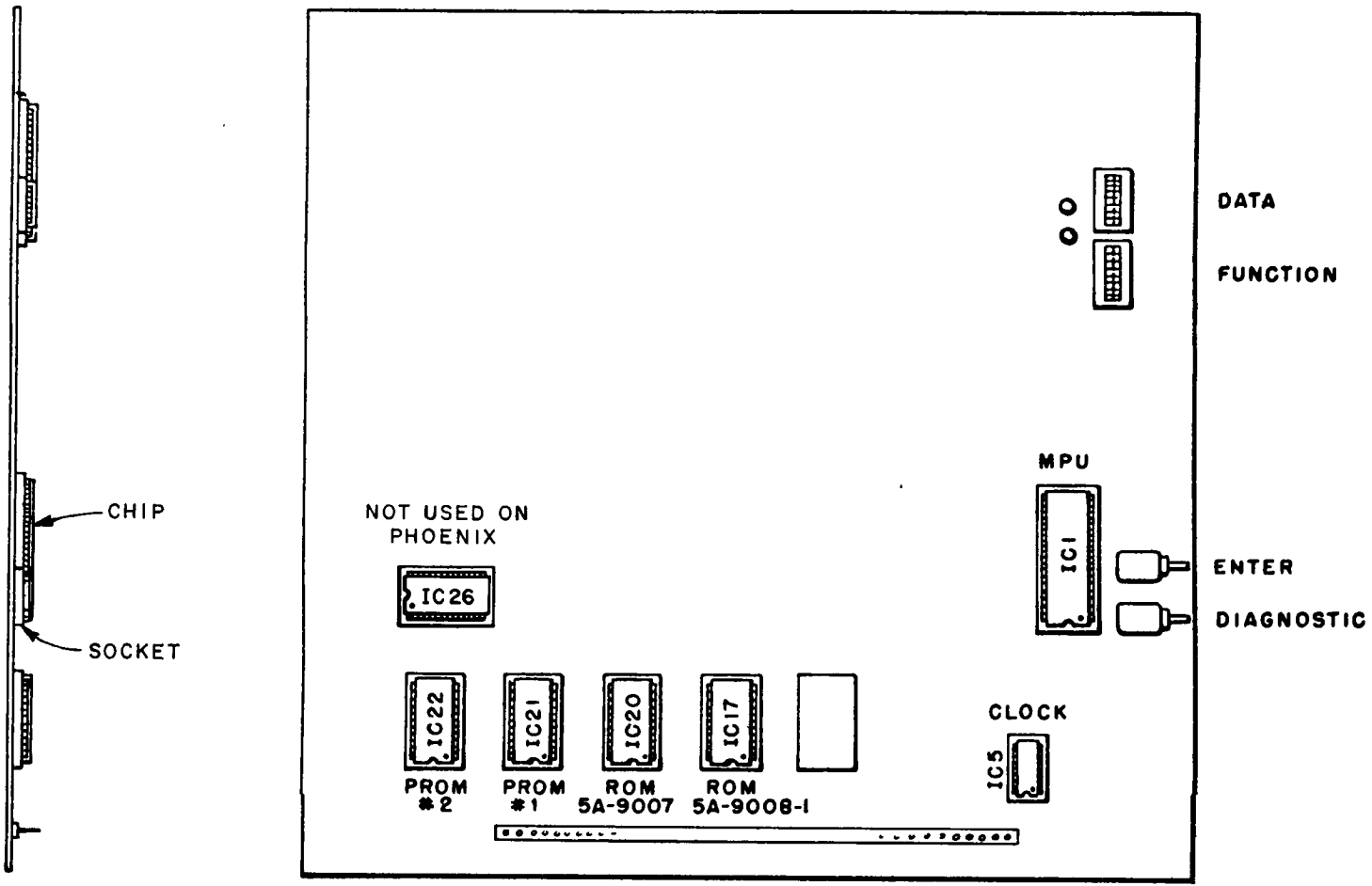

Figure 2. Location of Socketed Components and Switches on CPU Board

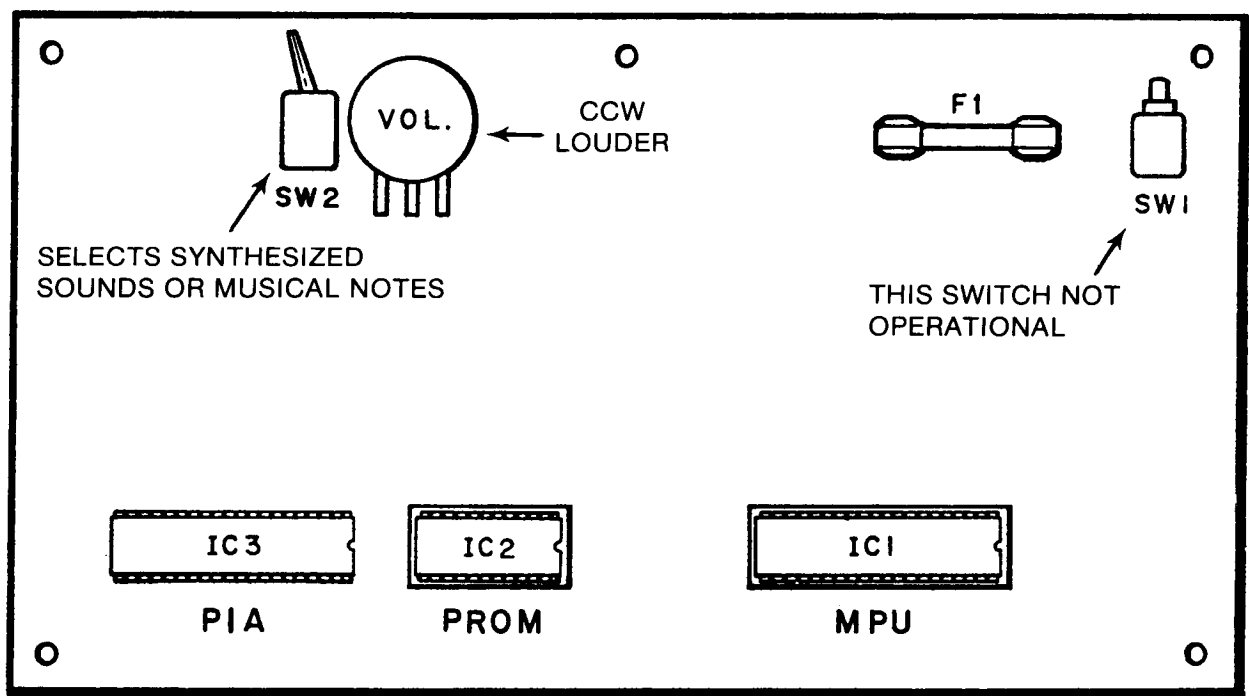

Figure 3. Location of Key Components on Sound Board

and flip the power switch located near the right front cabinet leg on. The game will come on and should come up in the game over mode.

The game over mode is indicated by player scores reading zero, player one up light flashing, game over lights lit. The high score to date will alternate with player one score only. Flippers will be inoperative and the general illumination lamps will be lit. The game can now be checked out by play, or diagnostics can be run (See Section 5), or game option adjustments can be made (See Section 3).

If the game comes up in the diagnostic mode, the ball in play display will show 04 (Figure 1 — No. 12B) and the credit display will show 01 (Figure 1 — No. 12A). This indicates that either the batteries were removed or came loose during shipment. The game status has returned to factory settings, and some values will probably have to be restored according to the procedure outlined in Section 3.

If the game does not light up or does not come up in game over or diagnostic mode, refer to troubleshooting Section 6.

SECTION 2 GAME OPERATION

Place ball into playfield by outhole. When machine is turned on it will come on in the game over mode. Player 1 up light will be flashing. All player scores will be zero and Player 1 score will alternate from zero to High Score to Date.* Game over lights will be lit.

Insert coin into the machine. The game should accept coins and post credits. The knocker will sound for each credit. Pressing the credit button on the cabinet front will cause the outhole kicker to serve the ball, the credit display will be reduced by one, the number of players light will show one, the ball in play will show 1 and the game start up tune will be played. Pressing the credit button at any time before the ball in play displays 2 will allow additional players and change the number of players light and reduce the credits by one for each additional player.

The player 1 up light will flash until the first switch is made. The left and right banks of drop targets will be reset; the center drop targets, however, are not reset. The left and right center drop targets are reset only by the "2" and "4" rollovers, respectively; or by the left and right inside rollovers, respectively.

Making "1" through "5" spots P-H-O-E-N-I-X; the "1" and "5" are both spotted by making either rollover. Spotting the letter "E" also turns on the Extra Ball When Lit lamp* for possible extra ball by hitting the Bull's-Eye target. Spotting the letter "I" alternately lights the left and right outside rollovers for a possible Special. Spotting the letter "X" enables a possible Special by hitting the Bull's-Eye target. Making the Bull's-Eye at this time turns "X" off. Spotting "1" through "5" again turns it on again for additional possible specials.

Making all four drop targets in either the left or right banks advances the "2X", "3X", "4X", and "5X" bonus multipliers and advances the bonus. Hitting the Bull's-

Eye target scores 5000 and one bonus advance or the highest lit P-H-O-E-N-I-X value.

The Spinner scores 100 or 1000 when lit. The spinner is lit when the bonus is advanced to 10,000 and is turned off when the bonus is advanced to 20,000. The left and right jet bumpers, left and right drop target bank standups, and the left and right kickers each score 10. The left standup, top right standup, and the bottom left and right standups each score 50. The center jet bumper scores 100. All other scoring is as indicated on the playfield.

When the ball leaves the playfield the bonus is collected and is not restored. For subsequent balls, the spotted numbers "1" through "5" and P-H-O-E-N-I-X letters are restored.

Extra ball * won during the course of the game is played immediately after the player's regular ball enters the outhole. After the last ball is played, the match digits appear where the ball in play digits were. If match occurs an extra credit will be awarded, * the game over tune will play and the game over lights will light. The high score to date will alternate with the winning player's score.

If a player's score exceeds the current high score to date, three * credits will be awarded, the game will play a high score to date tune, and the highest score to date lights will remain lit.

The plumb bob tilt tilts the ball in play on the third* closure. The ball roll and playfield shake tilt switches tilt the ball in play immediately. The super slam tilt on the coin door sets all player scores to zero and returns the game to game over.

If coins are inserted or credits won and the maximum * number of credits is exceeded, the credits will be posted correctly but the coin lockout coil will be de-energized until the number of remaining credits is below the maximum. While the coil is de-energized, no credits may be won.

* These features are adjustable and the procedure is outlined in Section 3.

SECTION 3 GAME ADJUSTMENTS

The solid state PHOENIX offers great versatility in customizing the game to the location or the operator's requirements. A very simple means of altering factory settings of various replay and other options has been devised. This section outlines the general procedure for making these changes.

Open the insert box door and locate the CPU Board (Figure 1 — No. 1). On the right hand side of the CPU Board there are two 8-position miniature slide switches and below them are two push-button switches.

To enter the diagnostic mode, depress the lower pushbutton switch (DIAGNOSTIC) on the CPU Board. The two LEDs to the left of the switches will blink twice and go off. If the LEDs do not blink twice or stay on continuously, refer to the troubleshooting guide in Section 6.

NOTE: It is not necessary to depress the **DIAGNOSTIC** pushbutton more than one time to make any number of changes.

Determine which function is to be changed by looking at Table 1. To change the third replay point, **for example**, is function number 3. The game is set to give the third replay when 410,000 points is exceeded but this can be raised or lowered very easily.

Next, since Function 03 is to be changed, set the **FUNCTION** (bottom) switch identically to the switch beside the number 03 in Chart 1. A black mark on Chart 1 next to the switch number indicates that that position of the lower switch is ON (move switch to the left). No black mark indicates that that position should be left OFF (move switch to the right).

The third step is to determine the new value for the third replay point. In this example, the third replay point will be raised from 410,000 points to 480,000 points. Table 1 specifies that Chart 2 is to be used when entering the data value and that the value entered is a multiple of 10,000 points. It requires 48 times 10,000 in order to get a value of 480,000 ($48 \times 10,000 = 480,000$), so a value of 48 would be entered on the **DATA** (top) switch. The **DATA** switch must be set identically to the switch beside number 48 in Chart 2. Data numbers may be specified as either Chart 1 or Chart 2 so care must be exercised to use the correct chart.

Once both the **FUNCTION** and **DATA** switches have been set correctly for the change desired, press the upper pushbutton switch (**ENTER**) one time. The two LEDs will blink once to indicate that the change has been made. If the LEDs do not blink when the **ENTER** switch is depressed and released, recheck switch settings.

Continue to enter any other changes desired by checking the other features in Table 1. Set the **FUNCTION** switch number for that feature on the function switch using Chart 1. Then determine the new data desired, and refer to either Chart 1 or Chart 2 and set the **DATA** switch accordingly. Then press the **ENTER** switch (top pushbutton) once to lock in the new data. Repeat this procedure for all changes.

The functions can be entered in any order. If a mistake is made in setting the data switches, the correct settings can be made and the **ENTER** switch pressed again to enter the new data. Only the last data entered will be retained. If the batteries are removed with the game turned OFF, all the changes made to the various features will be lost and the game will be restored to the factory settings.

There are two ways to verify the data changes entered. One is to turn the game OFF then ON again and then to play the game to see if the changes are correct. A faster method is to use Test 4 of the built-in diagnostics to read out the changes and this method is described in Section 5 of this manual.

The following is a summary of all adjustable game features.

REPLAYS

There are four possible replays awarded from scoring. The factory setting for the first replay occurs at 230,000

points; the second replay occurs at 320,000 points; the third replay at 410,000; and the fourth replay is disabled. Replay 1 is function number 01. It can be increased or decreased by any multiple of 10,000 points. Table 1 specifies to use Chart 2 for setting the data switch. **For example**, to establish a replay of 250,000 points instead of 210,000 points a value of 25 ($25 \times 10,000 = 250,000$) must be entered on the data switch, using Chart 2 to set up the **DATA** switch and Chart 1 to set up Function 01 in the **FUNCTION** switch.

1. **If not already in diagnostics**, enter diagnostics by pressing the lower pushbutton once.
2. Set up **FUNCTION** switch exactly like switch 01 in Chart 1.
3. Set up **DATA** switch exactly like switch 25 in Chart 2.
4. Press **ENTER** button once. The LEDs will blink once and the new data is locked in.

When the above four step procedure is completed the first replay will be 250,000 points. To change the 2nd, 3rd, or 4th replays, enter Function 02, 03 or 04 in step 2 above and follow steps 1 thru 4, substituting the new desired value in step 3.

To disable a replay point, turn **all** data switches ON (move switch to the left). Follow the procedure steps 1 thru 4, except that in step 3 remember to turn all switches ON. Note also that the replays must be different from one another and that they must be entered in ascending order. Replay 1 is the lowest replay; Replay 2 is the next replay followed by Replays 3 and 4. The replay points can be any multiple of 10,000 points or they can be disabled altogether.

MAXIMUM CREDITS

Maximum credits is the number of credits that can be posted (by putting coins in the game or free credit awards) before the coin lockout relay is released. The factory setting is 20 credits. According to Table 1, maximum credits is Function 05. It can be set for any value from 01 to 99 using Chart 2 for the data switch. To establish maximum credits of 10 **for example**, the function switch must be set to 05 using Chart 1 and the data switch set to 10 using Chart 2.

1. **If not already in diagnostics**, enter diagnostics by pressing the lower pushbutton once.
2. Set up function switch exactly like switch 05 in Chart 1.
3. Set up data switch exactly like switch 10 in Chart 2.
4. Press **ENTER** button once. The LEDs will blink once to indicate that the new data is locked in.

MATCH/CREDIT/EXTRA BALL/SPECIAL

Whenever a replay point is exceeded, the game can be set to award a credit (free game) or an extra ball. In addition, at the conclusion of a game, a match feature is available to award a credit (free game) if the last two digits match that of the player(s) last two score digits. This feature is Function 06 and Table 1 specifies that for Function 06 Chart 1 is to be used for the data switch values.

CHART 1

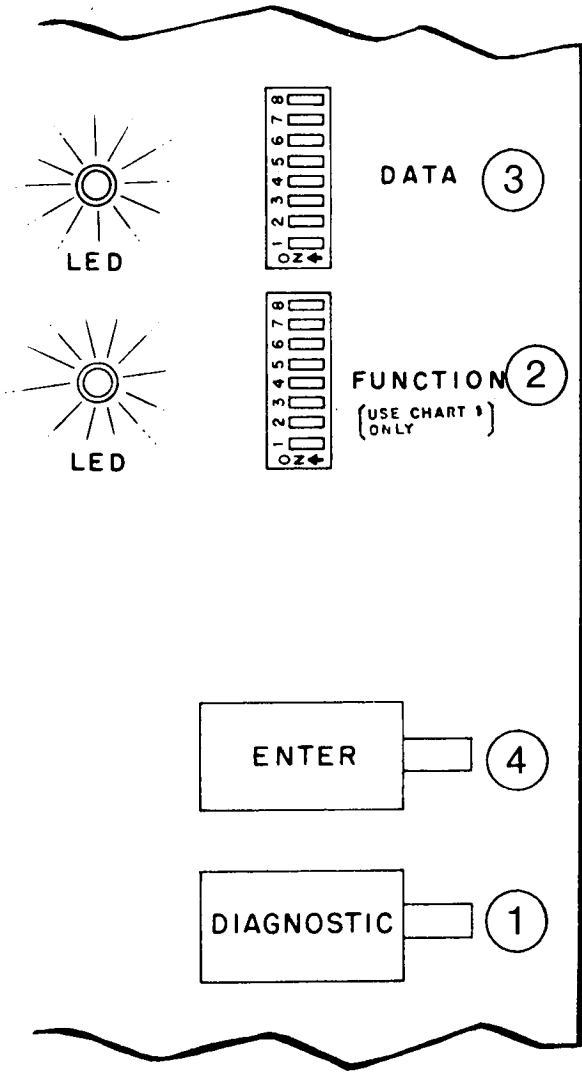

00	08	16	24
01	09	17	25
02	10	18	26
03	11	19	27
04	12	20	28
05	13	21	29
06	14	22	30
07	15	23	31

Game Adjustment Procedure

1. Depress DIAGNOSTIC switch and check that LEDs flash twice and that all displays are blank.
2. Set FUNCTION switch according to Chart 1.
3. Set DATA switch according to Chart 1 or Chart 2 as indicated in Table 1.
4. Depress ENTER switch and check that LEDs flash once.
5. Repeat steps 2 through 4 for additional adjustments, as required.
6. After all changes have been entered, verify adjustments using Test 4 as described in Section 5 or, alternately, verify by playing the game.

NOTE

Do not depress the DIAGNOSTIC pushbutton more than one time when making a number of changes.

Table 1. Game Adjustment Values for PHOENIX (Revision A PROMs)

Test 04 Readout No.	Function Switch (Chart 1)	Data Switch (Chart 1 or Chart 2)	Factory Setting	This Game
01	01	Replay 1 (Chart 2) 10,000 pts*	230,000 (23)	330,000
02	02	Replay 2 (Chart 2) 10,000 pts*	320,000 (32)	500,000
03	03	Replay 3 (Chart 2) 10,000 pts*	410,000 (41)	0
04	04	Replay 4 (Chart 2) 10,000 pts*	Disabled	0
05	05	Maximum Credits (Chart 2)	20	10
06	06	Match/Credit/Extra Ball (Chart 1)	08	08
		08 - Match ON-Credit award at Replay Points		
		09 - Match ON-Extra ball award at Replay Points, no credit on special		
		#12 - Match OFF-Credit award at Replay Points		
		#13 - Match OFF-Extra ball award at Replay Points, no credit on special		
07	07	Play (Chart 2)	02	_____
		02-Normal Play ("P" and "H" together)		
		03-Conservative Play ("P" and "H" separate)		
		04-No Extra Ball ("P" and "H" together)		
08	08	Credits awarded for High Score To Date (Chart 1)	03**	_____
09	12	Left coin slot multiplier (Chart 1)	01	_____
10	13	Center coin slot multiplier (Chart 1)	01	_____
11	14	Right coin slot multiplier (Chart 1)	01	_____
12	15	Minimum coin units for credit (Chart 1)	00	_____
13	16	Coin units bonus point (Chart 1)	02	_____
14	17	Coin units required for credit (Chart 1)	01	_____
15	18	Play adjustment (Chart 2)	13	_____
		##13 - Special awards credit, 3 balls		
		23 - Special awards extra ball, 3 balls		
		43 - Special awards 50,000 points, 3 balls		
		##15 - Special awards credit, 5 balls		
		25 - Special awards extra ball, 5 balls		
		45 - Special awards 50,000 points, 5 balls		
16	19	‡ Maximum Plumb Bob Tilts (1-9) (Chart 2)	03	_____
17	20	Credits in game (Chart 2)	00	_____
18	21	High score to date (Chart 2) 10,000 pts	35	_____
	22	High score to date (Chart 2) 100 pts	00	_____
	23	High score to date (Chart 2) 1 pt	00	_____
19	—	Number of coins left chute	Cannot be set	
20	—	Number of coins center chute	Cannot be set	
21	—	Number of coins right chute	Cannot be set	
22	—	Number of credits paid	Cannot be set	
23	—	Number of credits won	Cannot be set	

* To disable a replay point, enter function number then turn all data switches ON.

** To eliminate high score to date feature, enter function number 08 then turn all data switches OFF.

Values above 09 from Chart 1 do not display correctly in test 04 readout.

Function 06 MUST be set to 08 or 12 for special awards credit.

‡ Do not enter a value of 00 for Function 19. If 00 is entered the plumb bob will not tilt the game.

CHART 2

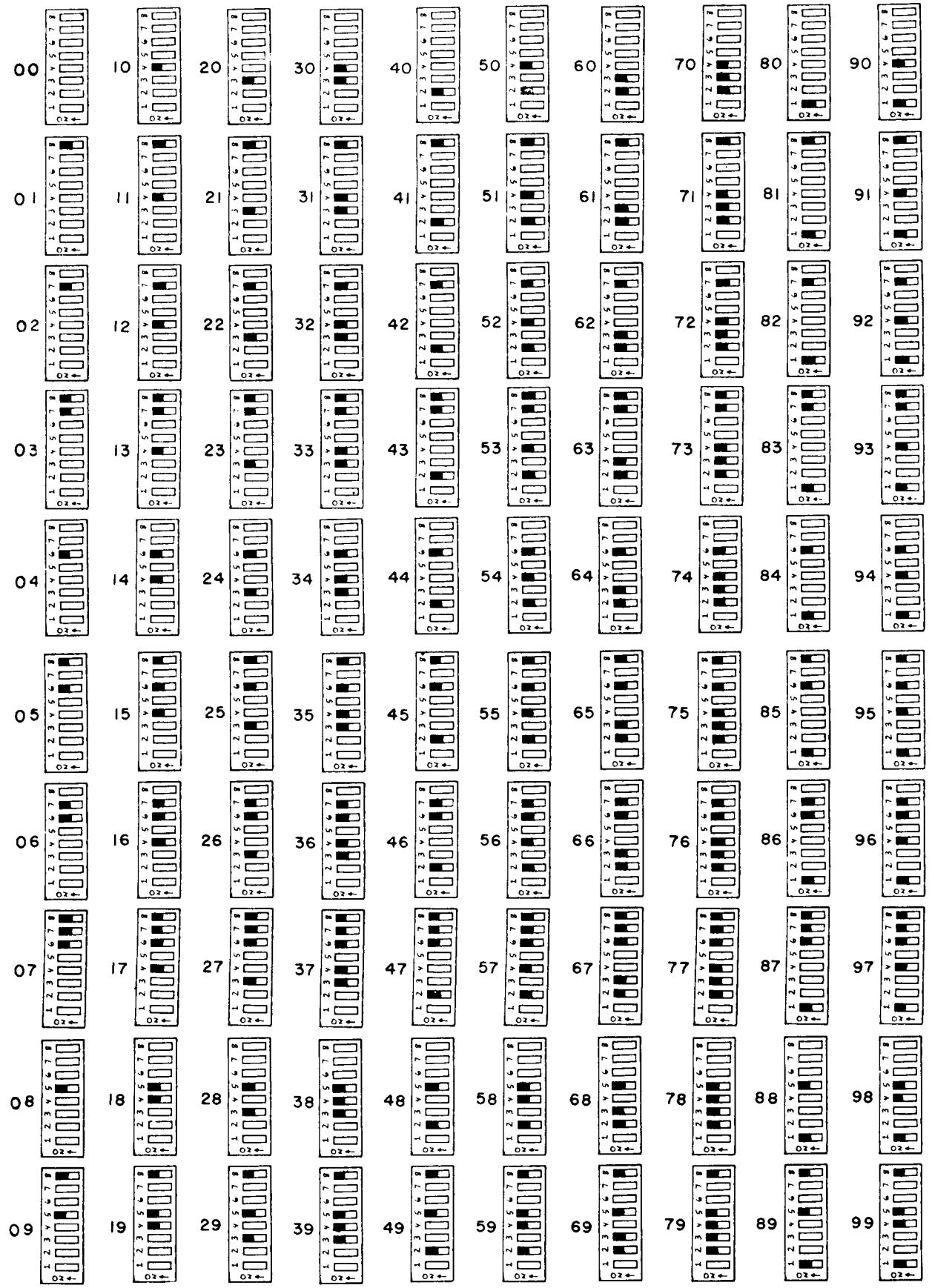

The factory setting is that the match awards an extra credit and that credits are awarded at the replay points. Table 1 also shows the various possibilities and the value to enter on the data switch.

Data Switch

- 08 -Match ON, Credit awarded at Replay points
- 09 -Match ON, Extra ball awarded at Replay points, no Credit for Special
- 12* -Match OFF, Credit awarded at Replay points
- 13* -Match OFF, Extra ball awarded at Replay points, no Credit for Special

1. **If not already in diagnostics**, enter diagnostics, by pressing the lower pushbutton once.
2. Set up function switch exactly like switch 06 in Chart 1.
3. Set up data switch like switch 08, 09, 12, or 13 in Chart 1.
4. Press ENTER button once. The LEDs will blink to indicate that the new data is locked in.

*Note that during the diagnostic test 4, the readouts on the Player 1 display will show 0 blank, not the corresponding data switch value. This is normal for any value entered in above 09 from Chart 1.

PLAY

This function controls the Extra Ball and the P-H-O-E-N-I-X lights. Spotting numbers "1" through "5" lights the letters sequentially. If the game play feature is set to "normal" (factory setting), spotting "1" through "5" the first time lights "P" and "H". Lighting "E" (by spotting "1" through "5" three times) lights the Extra Ball When Lit lamp for the Bull's-Eye target. Hitting the Bull's-Eye at this time awards an extra ball.

If the game play feature is set to "conservative," letters "P" and "H" are lit separately. The Extra Ball light would then be lit the fourth time numbers "1" through "5" are spotted.

If the game play feature is set to "no extra ball," letters "P" and "H" are lit together and the Extra Ball light will not come on from spotting "1" through "5" any number of times.

The game play feature is Function 07. Table 1 specifies that for Function 07 the data switch is set using Chart 2. Table 1 also shows the various possibilities and the value to enter on the data switch.

Data Switch

- 02 -Normal Play ("P" and "H" together)
- 03 -Conservative Play ("P" and "H" separate)
- 04 -No Extra Ball ("P" and "H" together)

1. **If not already in diagnostics**, enter diagnostics by pressing the lower pushbutton once.
2. Set up the function switch exactly like switch 07 in Chart 1.
3. Set up data switch to 02, 03, or 04 for the play feature using Chart 2.
4. Press ENTER pushbutton once. The LEDs will blink to indicate that the new data is locked in.

HIGH SCORE CREDITS

This function controls the high score to date feature. When the highest score to date is exceeded by a player, any number of free credits can be awarded.

High score to date is function 08 and Table 1 specifies to use Chart 1 for setting the data switch. If a value of zero is entered for the data, this feature is disabled and the high score to date is not displayed. If more than 9 free credits are awarded, the number displayed in test 4 readout of this function will be incorrect but the correct number of free credits will be awarded.

1. **If not already in diagnostics**, enter diagnostics by pressing the lower pushbutton once.
2. Set up function switch exactly like switch 08 in Chart 1.
3. Set up data switch according to Chart 1 for the number of credits to be awarded. To disable, enter a value of zero (All data switches off).
4. Press ENTER pushbutton. The LEDs will blink to indicate that the new data is locked in.

PLAY ADJUSTMENT

This function controls two game features simultaneously. The first feature is 3 ball play or 5 ball play. In addition the "special" features can be set to award a free credit, an extra ball, or 50,000 points. Note that when function 06 is set to award extra balls on replay points, the special feature cannot award a credit.

The factory setting is 3 ball play and "special" awards a free credit. Play adjustments is function 18 and Table 1 specifies to use Chart 2 for the data switch. There are 6 possible combinations for play adjustments. Table 1 also shows the various possibilities and the value to enter on the data switch.

Data Switch

- 13 - Special awards credit, 3 balls
- 23 - Special awards extra ball, 3 balls
- 43 - Special awards 50,000 points, 3 balls
- 15 - Special awards credit, 5 balls
- 25 - Special awards extra ball, 5 balls
- 45 - Special awards 50,000 points, 5 balls

1. **If not already in diagnostics**, enter diagnostics by pressing the lower pushbutton once.
2. Set up function switch exactly like switch 18 in Chart 1.
3. Set up data switch according to Chart 2 for the type of play adjustment desired.
4. Press ENTER pushbutton. The LEDs will blink to indicate that the new data is locked in.

MAXIMUM TILTS (Plumb Bob Tilts Only)

This function controls the multiple tilt feature. The plumb bob tilt only can set so that the ball in play does not tilt the first time that the bob contacts the ring. The factory setting for this feature is tilt the third time but the game can be made more conservative or liberal by setting this feature so that the ball in play tilts the first (or fourth) time that the plumb bob contacts the ring. All other tilts do not have this multiple tilt capability; only the plumb bob tilt.

1. **If not already in diagnostics**, enter diagnostics by pressing the lower pushbutton once.
2. Set up function switch exactly like switch 19 in Chart 1.
3. Set up data switch according to Chart 2 for any value from 01 to 09.
4. Press ENTER pushbutton once. The LEDs will blink to indicate that the new data is locked in.

CREDITS IN GAME

The number of credits in the game can be set to any number using this function. This allows free credits to be entered into the game or credits to be removed. Credits in the game is function 20 and Table 1 specifies to use Chart 2 for the value to be entered on the data switch.

For example, to put 10 free credits into a game with no credits, Function 20 would be set on the function switch and 10 would be set on the data switch. Once the two switches are set and the ENTER pushbutton pressed the game will have 10 credits in it. On the other hand, if a game has 19 credits in it at the end of play, these could be removed by entering function 20 on the function switch and entering a value of zero on the data switch. Once the two switches are set and the ENTER pushbutton pressed the game will have zero credits in it.

1. **If not already in diagnostics**, enter diagnostics by pressing lower pushbutton once.
2. Set up function switch exactly like switch 20 in Chart 1.
3. Set up data switch according to Chart 2 for whatever number of credits desired.
4. Press ENTER pushbutton once. The LEDs will blink to indicate that the new data is locked in.

HIGH SCORE TO DATE

The high score to date feature is arranged as three separate functions to allow resetting the high score to date to any value. The factory setting for high score to date is 350,000 points. Functions 21, 22 and 23 allow setting the score to any 6 digit number desired; any value from 000,000 to 999,999 can be set for the high score to date. Function 21 is set on the function switch and any number from 00 to 99 can be set on the data switch. Function 21 sets up the value of the 100,000 and 10,000 points digits.

When function 22 is set on the function switch, the number entered on the data switch will correspond to the 1,000 and 100 points digits.

When Function 23 is set on the function switch, the number entered on the data switch will correspond to the 10 and 1 point digits.

For example, to make the high score to date 525,680 points, three steps are required.

First, function 21 is set on the function switch (use Chart 1) and 52 would be set on the data switch using Chart 2. Then press the ENTER pushbutton. This would lock in the 52 part of 525,680.

Step two would be to set function 22 on the function switch (use Chart 1) and 56 on the data switch using

Chart 2. Then press the ENTER pushbutton. This would lock in the 56 part of 525,680.

The third and final step would be to set function 23 on the function switch (using Chart 1) and 80 on the data switch using Chart 2. Then press the ENTER pushbutton. This would lock in the 80 part of 525,680, completing the setting of the high score to date.

When changing a high score to date, it is not necessary to change all six digits. For example, if the high score to date was 674,550, just the first two digits could be changed, resulting in a new high score to date of XX4,550, where XX is the number entered on the data switch for function 21. If 34 was entered for example, the high score to date would be 344,550. If 72 was entered the high score to date would be 724,550; etc.

1. **If not already in diagnostics**, enter diagnostics by pressing lower pushbutton once.
2. Set up function switch exactly like 21, 22 or 23 in Chart 1.
3. Set up data switch for the new value for the two digits selected using Chart 2.
4. Press the ENTER pushbutton once. The LEDs will blink to indicate that the new data is locked in.
5. Repeat steps 2 thru 4 to change any other of the digit pairs, using the appropriate function number in step 2.

GAME PRICING

Refer to Table 2 at the end of this section for sample game pricing. To use Table 2, first refer to the section describing the coin door in your game. Then, if not already in diagnostics, start diagnostics by pressing the lower pushbutton on the CPU Board. Next, select the price scheme desired. Then, using Chart 1, set up Function 12 on the bottom switch. Next, set up the new data shown for the price scheme selected on the data switch using Chart 1. Then press ENTER pushbutton to lock in this change. Continue to do all the changes required for the price scheme selected by setting the next function number on the function switch, entering the new value on the data switch and press ENTER pushbutton.

The following is a more in-depth explanation of game pricing.

There are six different functions used to set the game pricing. Three pertain to the coin door mechanism and the other three determine how credits are awarded. Since there are many combinations of coin values and coin mechanisms, this explanation will detail how the functions relate to each other and describe sample settings and pricing schemes.

The first step in setting game pricing is to establish the number of coin chutes. There are single, twin, or three chute coin doors. Function 12 will be used for the left coin chute (closest to the hinge on coin door). Function 13 will be used for the center coin chute. Function 14 will be used for the right coin chute. If any given chute is not present, that function number can be ignored. For example, in a twin chute mechanism, the center chute is not used so Function 13 can be ignored.

The second step is to establish the ratio of all the coins for the particular coin door being used. If all the coins are of

equal value, they would have a ratio of 1:1:1. If the coins are not equal (as is the case for 5¢, 10¢, 25¢ coin door), establish the ratio by dividing the coin values by the largest number possible which leaves a remainder of zero. For the 5, 10, 25 coin door this number is 5 and the ratio would be 1:2:5. The 25¢ is worth 5 times the 5¢. The 10¢ is worth 2 times the 5¢. These ratios become the values for the data switch for functions 12, 13, and 14. For example, in the twin quarter chute, the ratio is 1:1:1 so that Function 12 would have its data value set to 01, Function 13 does not matter since there is no center chute in a twin quarter chute coin door, and Function 14 would have its data value set to 01.

The relative value of all the coins has now been established. The third step is to determine if there is to be a minimum amount that must be put into the game prior to giving **any** credits. For example, a 75¢ minimum could be established. No credits would be given until at least 75¢ is deposited in the game. The minimum is Function 15. If there is no minimum required, enter a value of 00 on the data switch for function 15. If a minimum is required, divide it by the same divider used to find the coin ratios. For a twin quarter machine, the number is 25. If 75¢ is required before giving any credits, $75¢ \div 25 = 03$ so a value of 03 must be entered on the data switch for function 15. Any minimum can be established, so long as the divider used to reduce the coin values goes into the minimum an even number of times (remainder must equal zero).

The fourth step in establishing game pricing is to determine the number of coins required to get a credit. Function 17 establishes how many coins are required to give a credit. The values entered in Function 12, 13, and 14 are used as a guideline. Each coin dropped through the coin chute will award the number of units as set by Functions 12, 13 and 14. For twin quarter chutes, if 1 quarter was required to award 1 credit, a 01 would be entered for data for function 17. If 2 quarters were required to award 1 credit, a 02 would be entered for data for function 17. If Functions 12, 13, and 14 are doubled, and Function 17 not changed, a coin would award 2 credits, establishing 2 play for 25¢. To easily determine the data value for Func-

tion 17, use the value entered for the lowest coin value and determine how many lowest value coins must be deposited to award a **single** credit.

The last step is to determine if there is a bonus (free game) to be awarded for depositing more than one coin at a time. For example, the factory settings are 1 play 25¢, 3 plays 50¢. This means that when the second coin is deposited, a free credit will be awarded.

Note that the bonus would be awarded only if the second (or additional) coin was deposited prior to the start of the game. Bonus credits is Function 16.

To determine the bonus credit value, use the value entered for Function 17 as follows: To award a bonus for every 2 credits worth of coins, enter double the value of Function 17 as the data for Function 16. To award a bonus credit for every 3 credits worth of coins, enter triple the value of Function 17 as the data for Function 16. To disable bonus credits enter a value of 00 for the data switch.

To make any changes to game pricing,

1. **If not already in diagnostics**, enter diagnostics by pressing lower pushbutton once.
2. Set up function switch exactly like 12, 13, 14, 15, 16, or 17 in Chart 1.
3. Set up data switch for the new value desired using Chart 1.
4. Press ENTER pushbutton once. The LED's will blink to indicate that the new data is locked in.
5. Repeat steps 2 thru 4 to change any of the other functions, using the correct function number in step 2 and the new data value required in step 3.

Note also that test 04 readout numbers listed in Chart 1 and the function numbers are different. Another caution is that if any values above 09 are entered, they will not display correctly during test 04 readout but the game will function correctly.

Table 2 shows some data values for functions 12 thru 17 for some of the more common pricing schemes.

Table 2. Setup for Common Pricing Schemes

FUNCTION NUMBER (CHART 1)	12	13	14	15	16	17
DATA VALUE (CHART 1)						
TWIN QUARTER DOOR						
1 Play 25¢, 3 Plays 50¢ (Factory Setting)	01	X	01	00	02	01
1 Play 25¢	01	X	01	00	00	01
2 Plays 25¢, 5 Plays 50¢	02	X	02	00	04	01
2 Plays 25¢	02	X	02	00	00	01
						X = Doesn't matter
SINGLE QUARTER DOOR						
1 Play 25¢, 3 Plays 50¢	X	01	X	00	02	01
1 Play 25¢	X	01	X	00	00	01
2 Plays 25¢, 5 Plays 50¢	X	02	X	00	04	01
2 Plays 25¢	X	02	X	00	00	01
						X = Doesn't matter
NICKEL, DIME, QUARTER DOOR						
1 Play 25¢, 3 Plays 50¢	01	02	05	00	10	05
1 Play 25¢	01	02	05	00	00	05
2 Plays 25¢	02	04	10	10	00	05
1 Play 15¢, 2 Plays 25¢	02	04	10	00	00	05
1DM, 5DM, 2DM DOOR						
2 Plays 1DM, 5 Plays 2DM, 14 Plays 5DM	13	65	26	00	65	05
1DM, 50 PHG., 2DM DOOR						
1 Play 50 PHG., 2 Plays 1DM, 5 Plays 2DM	02	01	04	00	04	01
5 FRANC, 10 FRANC DOOR						
1 Play, 5 Franc	01	X	02	00	00	01
1 Play 10 Franc	01	X	02	00	00	02
						X = Doesn't matter
25 CENT, 1 GUILDER DOOR						
1 Play 25¢	01	X	04	00	00	01
						X = Doesn't matter
1 FRANC DOOR						
1 Play 1 Franc, 3 Plays 2 Franc	X	01	X	00	02	01
1 Play 1 Franc	X	01	X	00	00	01
						X = Doesn't matter

SECTION 4 GAME BOOKKEEPING

The game is designed with operator in mind. There are 5 separate game bookkeeping totals which can be accessed from the coin door. (See Figure 4).

With the game in the **game over mode**, set the AUTO/MANUAL diagnostic switch in the coin door to MANUAL. Then press the ADVANCE pushbutton once. This immediately enters the diagnostic at test 4, subtest 18. This displays the current high score to date in the Player 1 display. Press the ADVANCE pushbutton again and this advances the diagnostic to test 4, subtest 19. This displays the number of coins through Slot 1. Press the ADVANCE pushbutton again to go to subtest 20, which displays the number of coins through Slot 2. Press the ADVANCE pushbutton again to go to subtest 21, which displays the number of coins through Slot 3.

There are two additional bookkeeping entries which are again accessed by pressing the ADVANCE pushbutton. Test 4, subtest 22 displays the number of credits paid for.

Pressing the ADVANCE pushbutton again advances to subtest 23, which displays the number of credits won.

To return to game over after reading out the bookkeeping totals, set the AUTO/MANUAL switch to AUTO and press the ADVANCE pushbutton once. This will return the game to game over.

Test 04 Subtest 18	High Score to Date
19	Number of Coins - Left Chute
20	Number of Coins - Center Chute
21	Number of Coins - Right Chute
22	Number of Credits paid
23	Number of Credits won

The bookkeeping totals are not resettable to zero, therefore a log similar to Figure 5 is recommended. If there is no center chute, the number displayed is of no significance and should be ignored.

The high score to date can be reset to the factory setting (350,000) from the coin door. With the game in the **game over mode**, momentarily depress the HIGH SCORE RESET pushbutton.

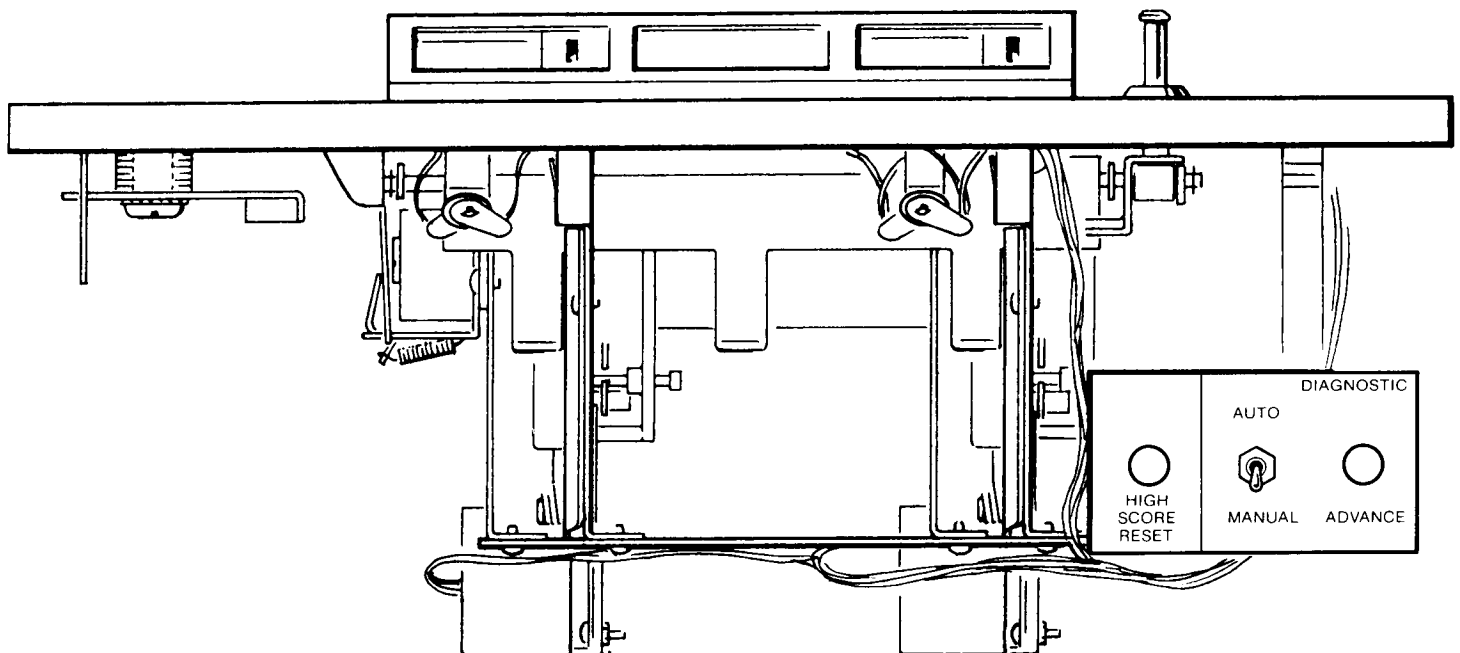

Figure 4. Location of Coin Door Diagnostic Switches

SECTION 5 BUILT IN DIAGNOSTICS

The built in diagnostics were designed for ease of operation and thoroughness. The diagnostics have been organized in such a way as to allow individual testing of different areas in the machine. These areas include:

- a) CPU Board Self-Test
- b) Game Status change
- c) Display digits test*
- d) Lamps (test 01)
- e) Solenoids (test 02)
- f) Switches (test 03)
- g) Game status display (test 04)*

*There are specific subtests in these tests. The different ways to enter the diagnostics and normal game operation are shown in Figure 6. There is also an auto cycle test which will be discussed later.

DIAGNOSTIC SWITCHES

There are three switches which are used to control the operation of the diagnostics:

1. Diagnostic switch (lower pushbutton on CPU)
2. Auto/Manual (inside coin door)
3. Advance switch (inside coin door)

Pressing the Diagnostic switch on the CPU Board initiates the diagnostics and causes the CPU to perform three self tests automatically:

1. ROM/PROM test
2. RAM test
3. CMOS RAM test

If any errors are detected, the two LEDs on the CPU Board will light to indicate the specific failure. If all three tests pass successfully, the two LEDs will blink twice and then go off. The diagnostics will then be in GAME STATUS CHANGE.



SOUND BOARD

Unlike previous solid state games, PHOENIX has no sound board diagnostics. Switch SW1 on the board is not operational. Refer to Section 6J for troubleshooting the sound board.

CPU BOARD SELF TESTS



ROM/PROM TEST

The ROM/PROM test specifically checks the contents of CPU Board IC 17, IC 20, IC 21, IC 22 to see if the information in the ROM's and the field PROMS is correct. If the information is incorrect, the bottom LED will light up and the top LED will be OFF on the CPU Board.

OFF  ROM/PROM failure
ON 

RAM TEST

The RAM test specifically checks the ability of the RAM IC's 13 and IC 16 to retain information correctly. If the information is not retained correctly, the CPU Board top LED will light up and the bottom LED will be OFF.

ON  RAM failure
OFF 

CMOS RAM TEST

The CMOS RAM test specifically checks the operation of IC 18 and the ability of the CMOS RAM IC 19 to retain information correctly. If the information is not retained correctly, both LEDs will light up and stay ON on the CPU Board.

ON  CMOS RAM failure
ON 

GAME STATUS CHANGE

Following the successful completion of the CPU Board self tests, the two LEDs blink twice and the diagnostic program enters the game status change area. This is the only time that changes can be entered as outlined in Section 3 of this manual. Replay points, maximum credits, match features, etc. can be changed ONLY during this portion of the diagnostics. Any changes made to the data will not be displayed until the game status display (test 04) described later. After making all game status changes (if any), press the ADVANCE pushbutton once to go to the digits test.

NOTE: This section of the diagnostic is the only section where ALL player and master display digits are turned OFF. No digits show on the displays until the next section of the diagnostics is entered by pressing the ADVANCE pushbutton on the coin door.

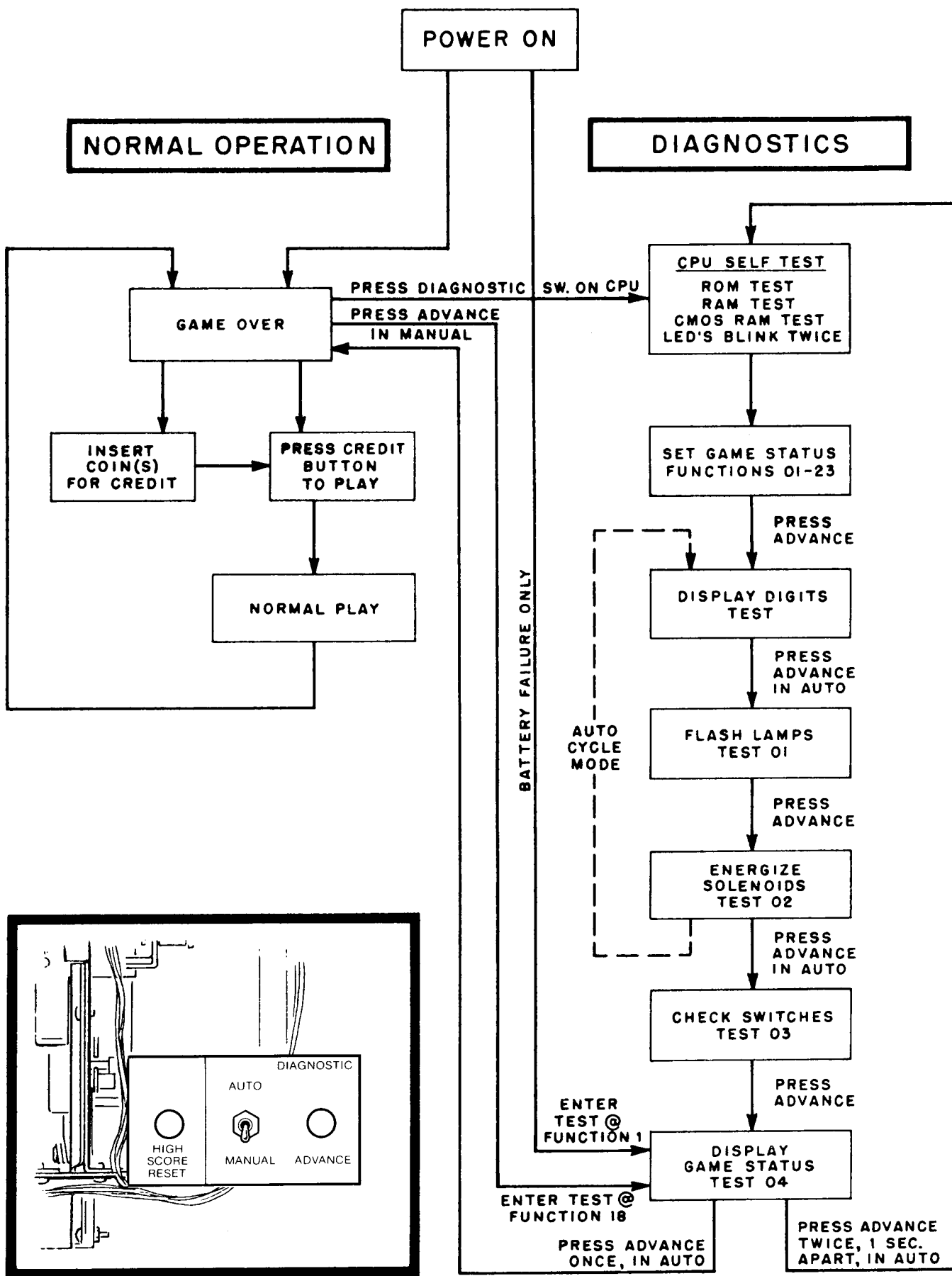

Figure 6. Normal Operation and Diagnostic Flow Chart

DISPLAY DIGITS TEST

This test is controlled by the two switches mounted on the coin door. If the AUTO/MANUAL switch is in the AUTO position, the digits on the display will alternate from 0 to 1 etc. to 9 and back to 0, 1, etc. This will continue until the ADVANCE pushbutton is pressed.

If the AUTO/MANUAL switch is in the MANUAL position when entering the test, the digit displays will show all zeros and will remain at zero until the ADVANCE is pressed. This will change all the displays to all 1's. Pressing ADVANCE again will change the display to all 2's etc. Each time the ADVANCE pushbutton is pressed the digits will change. Returning the AUTO/MANUAL switch to the AUTO position will cause the digits to start cycling automatically. To regain manual control, place the AUTO/MANUAL switch to the MANUAL position and press the ADVANCE pushbutton. To exit this test and proceed to the LAMP Test (Test 01), place the AUTO/MANUAL switch to the AUTO position and press the ADVANCE pushbutton once. All the displays will clear. The match digits will display 01 to indicate test 01 and the diagnostic will go to the lamp test.

LAMP TEST — TEST 01

This test causes all multiplexed lamps to blink on and off. The AUTO/MANUAL switch has no effect in this test. All lamps will continue to blink until the ADVANCE pushbutton is pressed. This causes the diagnostic to proceed directly to the Solenoid Test (Test 02). Note that the general illumination lamps do not blink on and off during this or at any other time.

SOLENOID TEST — TEST 02

When this test is entered the match digits will display 02 to indicate test 02. This test is controlled by the AUTO/MANUAL switch and the ADVANCE pushbutton.

This test is designed to pulse each solenoid for 15 milliseconds. The credit display will indicate the number of the solenoid being pulsed. Refer to Chart 3 for the solenoid identification list. Note that the solenoid numbers 8, 15, and 22 are not used. Also note that the first pulsing of solenoid 9 after solenoid 13 is pulsed will produce the startup tune.

If the AUTO/MANUAL switch is in the AUTO position when this test is entered, the test will automatically sequence from solenoid 01 to 02 to 03 etc. to 22 and back to 01, 02, 03 etc. This will continue until either the ADVANCE pushbutton is pressed to go on to the next test or the AUTO/MANUAL switch placed to the MANUAL position and the ADVANCE pushbutton pressed, causing the test to cycle only the solenoid where the pause occurred.

If the AUTO/MANUAL switch is in the MANUAL position when this test is entered, the test will operate solenoid 01 repeatedly until the advance pushbutton is

pressed. Then the solenoid 02 will be operated repeatedly until the ADVANCE pushbutton is again pressed. Placing the AUTO/MANUAL switch to the AUTO position at any time will cause automatic sequencing to resume. When the ADVANCE pushbutton is pressed with the AUTO/MANUAL switch in the AUTO position, the diagnostics will advance to the SWITCH TEST.

SWITCH TEST — TEST 03

When this test is entered the match digits will display 03 to indicate test 03. The position of the AUTO/MANUAL switch has no effect on the operation of this test.

After entering this test, the credit display will display up to four switches on the playfield that are closed or stuck. After this listing is complete only the last switch closed will be indicated. If NO switches are closed when this test is entered the credit display will be blank.

All switches can be checked by closing the switch manually and observing that the switch number appears in the credit display. To exit this section of the diagnostics, press the ADVANCE pushbutton to go to the display game status test 04.

Refer to Figure 7 for the description and location of all switches in the playfield. Note that switches 01 thru 08 are not on the playfield itself.

Chart 3 PHOENIX SOLENOID LIST

- 01 Ball Release
- 02 Left Center Drop Target Reset
- 03 Left Bank, Bottom Drop Targets Reset
- 04 Left Bank, Top Drop Targets Reset
- 05 Right Bank, Top Drop Targets Reset
- 06 Right Bank, Bottom Drop Targets Reset
- 07 Right Center Drop Target Reset
- 08 Not Used
- 09 10 Point Sound*
- 10 100 Point Sound
- 11 1,000 Point Sound
- 12 10,000 Point Sound
- 13 Sound Alternator
- 14 Credit Knocker
- 15 Not Used
- 16 Coin Lockout
- 17 Left Jet Bumper
- 18 Center Jet Bumper
- 19 Right Jet Bumper
- 20 Left Kicker
- 21 Right Kicker
- 22 Not Used

*First pulsing of solenoid 09 after solenoid 13 is pulsed produces startup tune.

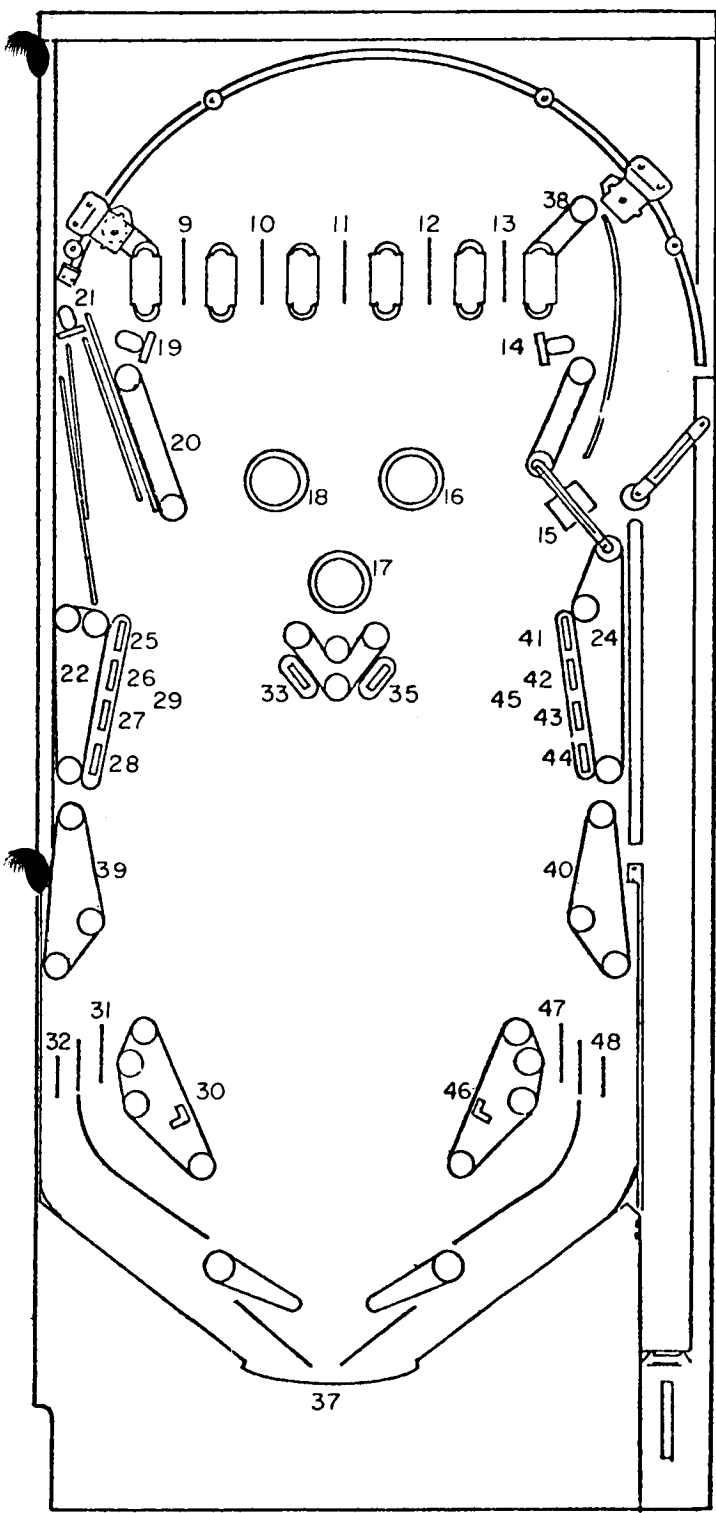

SWITCH FUNCTION

- 01 PLUMB BOB TILT
- 02 BALL ROLL TILT
- 03 CREDIT BUTTON
- 04 RIGHT COIN SWITCH
- 05 CENTER COIN SWITCH
- 06 LEFT COIN SWITCH
- 07 SLAM TILT
- 08 HIGH SCORE TO DATE RESET*
- 09 "1" ROLLOVER
- 10 "2" ROLLOVER
- 11 "3" ROLLOVER
- 12 "4" ROLLOVER
- 13 "5" ROLLOVER
- 14 RIGHT TARGET
- 15 SPINNER
- 16 RIGHT JET BUMPER
- 17 CENTER JET BUMPER
- 18 LEFT JET BUMPER
- 19 LEFT TARGET
- 20 LEFT STANDUP
- 21 BULL'S-EYE TARGET
- 22 LEFT DROP TARGET BANK STANDUP
- 23 PLAYFIELD TILT
- 24 RIGHT DROP TARGET BANK STANDUP
- 25 LEFT DROP TARGET BANK, TOP
- 26 LEFT DROP TARGET BANK, TOP CENTER
- 27 LEFT DROP TARGET BANK, BOTTOM CENTER
- 28 LEFT DROP TARGET BANK, BOTTOM
- 29 LEFT DROP TARGET BANK SERIES
- 30 LEFT KICKER
- 31 LEFT INSIDE ROLLOVER
- 32 LEFT OUTSIDE ROLLOVER
- 33 LEFT CENTER DROP TARGET
- 34 NOT USED
- 35 RIGHT CENTER DROP TARGET
- 36 NOT USED
- 37 OUTHOLE
- 38 TOP RIGHT STANDUP
- 39 BOTTOM LEFT STANDUP
- 40 BOTTOM RIGHT STANDUP
- 41 RIGHT DROP TARGET BANK, TOP
- 42 RIGHT DROP TARGET BANK, TOP CENTER
- 43 RIGHT DROP TARGET BANK, BOTTOM CENTER
- 44 RIGHT DROP TARGET BANK, BOTTOM
- 45 RIGHT DROP TARGET BANK SERIES
- 46 RIGHT KICKER
- 47 RIGHT INSIDE ROLLOVER
- 48 RIGHT OUTSIDE ROLLOVER

IN CABINET

*Not provided on prototype games

Figure 7. Switch Chart and Location of Playfield Switches

DISPLAY GAME STATUS — TEST 04

When this test is entered, the match digits will display 04 to indicate test 04. This test displays on Player 1 display the current game status for the 18 functions that can be changed according to section 3 in this manual and for the 5 bookkeeping totals which can be accessed as described in Section 4. Changes to the game status CANNOT be made at this time! To make changes the diagnostics must be in the Game Status Change section of the diagnostics as previously explained.

When this test is entered, if the AUTO/MANUAL switch is in the AUTO position the test will sequentially display the game status data values on the Player 1 display and the function number on the credits display and continue cycling until the ADVANCE pushbutton is pressed. If the ADVANCE pushbutton is pressed once, the diagnostics will end and the game will go to the GAME OVER mode. If the ADVANCE pushbutton is pressed once and then after a 1 second pause pressed a second time, the diagnostics will start all over again with the CPU Self Tests and then go to Game Status Change section of the diagnostics.

If the AUTO/MANUAL switch is in the MANUAL position when the test is entered, the credit display will show 01, Player 1 display the value of whatever is function 01, and will remain that way until the ADVANCE pushbutton is pressed, at which time the value for function 02 will be display on Player 1 display and 02 will display in the credit display. Each time the ADVANCE pushbutton is pressed, the credit display will increment by 1, until 23 is reached then it will return to 01. This will continue until the AUTO/MANUAL switch is returned to the AUTO

position and the ADVANCE pushbutton pressed once or twice as described above. Note that for test 4 function numbers 6 and 8 thru 14, values above 09 will not be displayed correctly. Refer to Table 1 for an explanation of the values read out during this test.

AUTO CYCLE MODE

As an aid in diagnosing intermittent problems or as a means to let the machine cycle itself through portions of the diagnostics, provision was made for the AUTO CYCLE MODE. This mode will sequence through the digit display test, go to test 01 and flash the lamps 128 times then go to test 02 and energize each solenoid then digit test, test 01, etc. This can be allowed to run indefinitely or until the ADVANCE pushbutton is pressed to regain control of the diagnostics.

To enter the AUTO CYCLE MODE:

1. Turn game OFF then turn game ON.
2. Press the diagnostic pushbutton on the CPU Board to enter diagnostics.
3. Set the data and function switches as follows:
DATA SWITCH (TOP SWITCH) — Turn **all** switches OFF. FUNCTION SWITCH (BOTTOM SWITCH) — Turn **all** sitches OFF then turn ON only switch 1.
4. Press ENTER pushbutton on CPU Board. The two LEDs will blink to accept the data.
5. Place the AUTO/MANUAL switch to AUTO.
6. Press ADVANCE pushbutton ONCE. The AUTO CYCLE MODE will begin and continue until the ADVANCE pushbutton is pushed again to regain manual control of the diagnostics or the machine is turned OFF.

SECTION 6 TROUBLESHOOTING CHARTS

This section, along with the diagnostics, allows the operator to locate any problems to the specific area responsible for the problem.

If game exhibits a specific problem with

- Lamp - See Section 6A
- Switch - See Section 6B
- Solenoid - See Section 6C
- Master Display - See Section 6D
- Player Display - See Section 6E
- Game Operation - See Section 6F

If the game does not play at all or blows fuses — See Section 6G

If the game plays intermittently — See Section 6H

If the game comes on in diagnostic test 04, subtest 01 — See Section 6I

If the game has sound problems—See Section 6J.

Section 6A — Place Diagnostics in Test 01

LAMP TROUBLESHOOTING CHART

1 LAMP

Always OFF

1. Check Bulb
2. Check Diode (Observe Polarity)
3. Check wiring (broken wires)

Glow DIM

1. Check Bulb (correct #bulb)
2. Check Diode (Observe Polarity)
3. Check wiring (shorted wires)

Always ON

1. Check Diode (Observe Polarity)
2. Check wiring (shorted wires)

4-8 LAMPS

Always OFF

1. Check wiring (broken wires)
2. Check Connectors (2J5, 2J7)
3. Replace Driver Board

Glow DIM

1. Check wiring (broken wires)
2. Check Diode
3. Check Connectors (2J5, 2J7)
4. Replace Driver Board

Always ON

1. Check wiring (shorted wires)
2. Check Diodes
3. Check Connectors (2J5, 2J7)
4. Replace Driver Board

ALL LAMPS

Always OFF

1. Check fuse 3F3 on Power Supply
2. Check for + 18 VDC on fuse 3F3 to ground
3. Check Connector 3J4
4. Check Connector 8P2/8J2
5. Check wiring (broken or shorts)
6. Replace Driver Board

Glow DIM

1. Check line voltage
2. Check for + 18 VDC on fuse 3F3 to ground

GENERAL ILLUMI.

Always ON

Normal Condition

Always OFF

1. Check Fuse on Power Fuse Card
2. Check for + 6.3 VAC
3. Check Connectors (3J3)
4. Check Connectors 9P1 and 8P2/8J2
5. Check wiring (broken or short)

Glow DIM

1. Check line voltage

All lamps are N44 or equivalent
All diodes are 1N4001 or equivalent

Section 6B — Place Diagnostics in Test 03

SWITCH TROUBLESHOOTING CHART

1 SWITCH

Always Actuated

1. Check contacts
2. Check shorted wires

Never Actuates

1. Check adjustment
2. Check broken wires
3. Check for open diode by jumpering across diode and actuating.

4-8 SWITCHES

Always Actuated

1. Check adjustments
2. Check shorted wires on playfield or to 2J2, 2J3
3. Replace Driver Board

Never Actuated

1. Check adjustment
2. Check broken wires on playfield or 2J2, 2J3
3. Check plug 8P1/8J1 for broken wires or pushed out pins
4. Replace Driver Board

Switch Closure Displays Multiple Switch Numbers

1. Check adjustments
2. Check shorted wires on playfield or to 2J2, 2J3
3. Replace Driver Board

Switch Displays Incorrect No.

1. Check correct switch chart for game and check adjustment
2. Incorrect wiring on playfield 2J2, 2J3, or 8P1/8J1
3. Check Connector keying

ALL SWITCHES

1. Check adjustments
2. Check Connectors 2J2, 2J3, are not exchanged
3. Replace Driver Board

Section 6C — Place Diagnostics in Test 02

SOLENOID TROUBLESHOOTING CHART

1 SOLENOID

Never Actuates

1. Check solenoid Chart to verify number correct and in use
2. Broken wire to solenoid
3. Shorted diode across solenoid
4. Shorted/burned out solenoid
5. Open driver for that solenoid - replace Driver Board

Always Actuated

1. Shorted wire for that solenoid
2. Shorted driver for that solenoid on Driver Board - replace Driver Board

ALL SOLENOIDS

Never Actuated

1. Check for + 28 VDC on Power Supply fuse 3F2 to ground
2. Check fuse 3F2 on Power Supply
3. Check Connectors 3J3 and 3J4 on Power Supply
4. Check Connector 2J9, 2J10, 2J11, 2J12 for broken/shorted wires.
5. Replace Driver Board

FLIPPERS

1 FLIPPER

Never Operates

1. Switch contacts on flipper button open or out of adjustment.
2. Shorted diode across coil.

Flipper Weak

1. Switch contacts on flipper button out of adjustment or pitted contacts.
2. End of stroke switch on solenoid not adjusted properly.
3. Check connections on solenoid and check for bind.

Operates with Game Over, etc.

1. Short in wiring to Driver Board.
2. Short on Driver Board or stuck 2Z1 Relay Contacts.

BOTH FLIPPERS

Never Operate

1. Check Fuse 8F1 on Playfield and 6P2 connection.
2. Diode or resistor in driver circuit shorted.
3. Relay 2Z1 on driver board faulty.
4. Other fault in driver circuit. Replace driver board.

Operate with Game Over, etc.

1. Faulty driver circuit on Driver Board; repair or replace.
2. Other fault on Driver Board; repair or replace.

Section 6D - Place Diagnostics in Display Digits Test

MASTER DISPLAY TROUBLESHOOTING CHART

NO DISPLAY

1. Check -100 VDC, $+100$ VDC & fuse 3F1 on Power Supply.
2. Check connectors 3J5, 4J7, 4J5, 1J3, 1J5, 1J6, 1J7
3. Check for $+100$ VDC and -100 VDC on connector 4J7 - replace Power Supply Board if voltage incorrect
4. Replace Master Display Board.

INCORRECT DISPLAY

1. Check $+100$ VDC, -100 VDC at 4J7
2. Check for broken or shorted wires on 4J5, 4J6, 1J5, 1J6, 1J7
3. Replace Master Display Board

Section 6E - Place Diagnostics in Display Digits Test

PLAYER DISPLAY TROUBLESHOOTING CHART

1 PLAYER DISPLAY INCORRECT/OFF

1. Check correct location of connector from Master Display Board.
2. Replace Player Display - if still incorrect, replace Master Display Board.

2-4 PLAYER DISPLAYS INCORRECT/OFF

1. Check correct location of connectors from Master Display Board
2. Check voltage $+100$ VDC and -100 VDC on connector 4J7
3. If voltages are correct - replace Master Display Board.

USE EXTREME CAUTION WHEN MEASURING HIGH VOLTAGES!!!

Section 6F - Game Operation Troubleshooting

Put game in game over mode. Manually play game to verify problem. Go to diagnostic mode and read out functions by stepping through test 04. Review the game adjustments to verify that they are what is desired. Review game operation (Section 2).

Section 6G - Troubleshooting an inoperative machine or a machine that blows fuses.

Machine Inoperative

1. Remove plug from wall outlet and measure wall voltage.
2. With machine unplugged, check the line fuse, line cord, and ON/OFF switch with an Ohmmeter for continuity.
3. Check for any loose connections on line filter, ON/OFF switch.
4. Check that power connector to transformer is securely connected.
5. Check all fuses on power supply board.
6. Plug machine in, turn on and check voltage on power supply board fuses.

Machine Blows Fuse

1. Wall fuse or circuit breaker blows -
 - a. Disconnect wall plug.
 - b. Disconnect connector from line filter to transformer.
 - c. Check line cord with Ohmmeter for shorts.
 - d. Check varistor and line filter for shorts.
 - e. Plug cord in wall and see if wall fuse still blows - if yes, disconnect whatever else is on same wall plug circuit and recheck items c and d above.
2. Machine fuse blows -
 - a. Check for correct fuse rating.
 - b. Check varistor, line filter, line cord for shorts.
 - c. Disconnect connector from line filter to transformer and try another fuse.
 - d. If fuse still blows, do item a, b, c again.
 - e. If fuse does not blow, disconnect 3P1 and 3P2 plugs from the power supply board and reconnect plug from line filter to transformer.
 - f. If fuse blows, check transformer and both lamps and solenoid rectifiers for shorts.
 - g. If fuse does not blow, plug in 3P2 and 3P1 then try again. If fuse now blows, disconnect 3P3, 3P4, 3P5, 3P6, and try another fuse. If fuse still blows replace POWER SUPPLY.
 - h. If fuse doesn't blow, hook up 3P3, 3P4, 3P5, and 3P6 one at a time. If fuse blows when any one is plugged, look for burned out solenoid, dead shorts, etc.

3. Individual Power Supply Fuse Blows

a) Disconnect load from portion of the power supply that blows the fuse by disconnecting the appropriate plug.

1. 3F1 (+100 VDC, -100 VDC) disconnect 3P5
2. 3F2 (+28 VDC) disconnect 3P4, 3P3
3. 3F3 (+18 VDC) disconnect 3P4
4. 3F4 (6.3 VAC) disconnect 3P3
5. 3F5 (+5 VDC) disconnect 3P6

b) If fuse still blows, replace POWER SUPPLY.

c) If fuse does not blow, check for shorts in wiring, burned out solenoids, etc.

Section 6H - Game plays intermittently.

This usually indicates a power supply or CPU board problem. Check the +5 VDC and the unregulated +5 VDC on the CPU board and on the power supply. If the voltage is correct, attempt to run the CPU self tests in the diagnostics. (See Section 5) If the CPU self tests fail, remove the DRIVER BOARD and attempt to run the CPU self tests again. If the diagnostics now run, replace the DRIVER BOARD. Otherwise, replace the CPU Board.

Section 6I - Game repeatedly comes on in diagnostic test 04, subtest 01.

This indicates that there has been either a battery failure or a CPU board failure. Measure the voltage across the batteries. If the voltage is below 3.0 VDC, replace the batteries with POWER ON and make any necessary game status changes if required. If the voltage is above 3.0 VDC, run the CPU Self Test diagnostics. If CMOS RAM test fails, replace the CPU Board.

Section 6J—Place Diagnostics in Test 02

SOUND TROUBLESHOOTING CHART

1 SOUND

Never Sounds

1. Check Solenoid Chart to verify number correct and in use.
2. Broken wire to 10J3 connector
3. Replace PROM on Sound Board
4. Open driver on Driver Board—Replace driver on Driver Board
5. Open buffer on Sound Board—Replace buffer on Sound Board.

2 OR MORE SOUNDS

Never Sound

1. Replace PROM on Sound Board.
2. Replace Sound Board.

ALL SOUNDS

Never Sound

1. Check fuses 10F1 on Sound Board and 7F2 adjacent to Sound Board.
2. Check connectors 10J1, 10J2 and 10J3
3. Check volume control position
4. Check amplifier portion of Sound Board
5. Replace PROM on Sound Board
6. Replace Sound Board

SECTION 7 INTERCONNECTION CHARTS

The following interconnection charts are used to identify the color and pin number of all the wires for all the components and typical wiring sketches for each type of circuit. The following conventions are used throughout —

1. 1J1 is connector J1 on board 1.
3J6 is connector J6 on board 3.
2. J designations refer to the male part of plug.
P designations refer to the female part of plug.
3. The Prefix numbers are as follows:
 1. CPU Board
 2. Driver Board
 3. Power Supply Board
 4. Master Display Board
 5. Slave Display Board
 6. Back Box Miscellaneous
 7. Cabinet
 8. Playfield
 9. Insert Box
 10. Sound Board

Refer to Figures 8, 9, 10, and 11 for the lamps matrix, switch matrix, solenoid matrix, and connector identification; respectively.

ROW \ COLUMN	1 YEL-BRN	2 YEL-RED	3 YEL-ORN	4 YEL-BLK	5 YEL-GRN	6 YEL-BLU	7 YEL-VIO	8 YEL-GRY
1 RED-BRN	NOT USED	"1"	EXTRA BALL WHEN LIT	"X2"	5,000	NOT USED	NOT USED	#1 PLAYER UP
2 RED-BLK	NOT USED	"2"	"P"	"X3"	6,000	NOT USED	1 CAN PLAY	#2 PLAYER UP
3 RED-ORN	NOT USED	"3"	"H"	"X4"	7,000	NOT USED	2 CAN PLAY	#3 PLAYER UP
4 RED-YEL	NOT USED	"4"	"O"	"X5"	8,000	NOT USED	3 CAN PLAY	#4 PLAYER UP
5 RED-GRN	NOT USED	"5"	"E"	1,000	9,000	SPINNER 1,000 W/L	4 CAN PLAY	TILT
6 RED-BLU	NOT USED	NOT USED	"N"	2,000	NOT USED	LEFT SPECIAL	MATCH	GAME OVER
7 RED-VIO	NOT USED	NOT USED	"I"	3,000	10,000	RIGHT SPECIAL	BALL IN PLAY	SAME PLAYER SHOOTS (BACK BOX)
8 RED-GRY	NOT USED	NOT USED	"X"	4,000	20,000	SAME PLAYER SHOOTS (PLAYFIELD)	CREDITS (PLAYFIELD)	HIGH SCORE

Figure 8. PHOENIX Light Matrix

ROW \ COLUMN	1	2	3	4	5	6	7	8
	GRN-BRN	GRN-RED	GRN-ORN	GRN-YEL	GRN-BLK	GRN-BLU	GRN-VIO	GRN-GRY
1 WHT-BRN	PLUMB TILT 1	"1" ROLLOVER 9	CENTER JET BUMPER 17	LEFT BANK, TOP DROP TARGET 25	LEFT CENTER DROP TARGET 33	RIGHT BANK TOP DROP TARGET 41	NOT USED 49	NOT USED 57
2 WHT-RED	BALL ROLL TILT 2	"2" ROLLOVER 10	LEFT JET BUMPER 18	LEFT BANK, TOP CENTER DROP TARGET 26	NOT USED 34	RIGHT BANK TOP CENTER DROP TARGET 42	NOT USED 50	NOT USED 58
3 WHT-ORN	CREDIT BUTTON 3	"3" ROLLOVER 11	LEFT TARGET 19	LEFT BANK, BOTTOM CENTER DROP TARGET 27	RIGHT CENTER DROP TARGET 35	RIGHT BANK BOTTOM CENTER DROP TARGET 43	NOT USED 51	NOT USED 59
4 WHT-YEL	RIGHT COIN SWITCH 4	"4" ROLLOVER 12	LEFT STANDUP 20	LEFT BANK BOTTOM DROP TARGET 28	NOT USED 36	RIGHT BANK BOTTOM DROP TARGET 44	NOT USED 52	NOT USED 60
5 WHT-GRN	CENTER COIN SWITCH 5	"5" ROLLOVER 13	BULL'S-EYE TARGET 21	LEFT BANK DROP TARGET SERIES 29	OUTHOLE 37	RIGHT BANK DROP TARGET SERIES 45	NOT USED 53	NOT USED 61
6 WHT-BLU	LEFT COIN SWITCH 6	RIGHT TARGET 14	LEFT BANK STANDUP 22	LEFT KICKER 30	TOP RIGHT STANDUP 38	RIGHT KICKER 46	NOT USED 54	NOT USED 62
7 WHT-VIO	SLAM TILT 7	SPINNER 15	PLAYFIELD TILT 23	LEFT INSIDE ROLLOVER 31	BOTTOM LEFT STANDUP 39	RIGHT INSIDE ROLLOVER 47	NOT USED 55	NOT USED 63
8 WHT-GRY	HIGH* SCORE RESET 8	RIGHT JET BUMPER 16	RIGHT BANK STANDUP 24	LEFT OUTSIDE ROLLOVER 32	BOTTOM RIGHT STANDUP 40	RIGHT OUTSIDE ROLLOVER 48	NOT USED 56	NOT USED 64

*High score reset not provided on prototype games.

Figure 9. PHOENIX Switch Matrix

TYPICAL WIRING

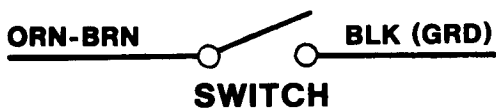

SPECIAL SOLENOIDS

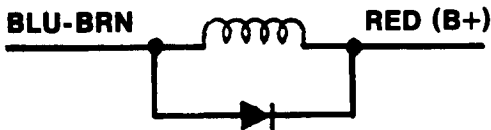

PLAYFIELD SOLENOIDS

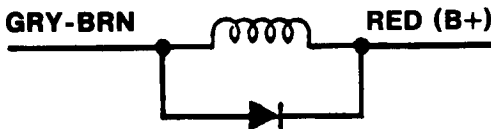

CABINET SOLENOIDS

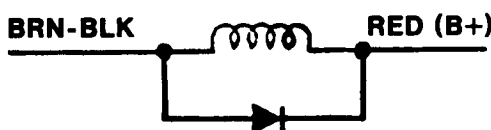

SPECIAL SOLENOIDS

SWITCH →	ORN-BRN
COIL →	BLU-BRN
	17
	LEFT JET BUMPER SG-23-900-DC
	ORN-RED
	BLU-RED
	18
	CENTER JET BUMPER SG23-900-DC
	ORN-BLK
	BLU-ORN
	19
	RIGHT JET BUMPER SG23-900-DC
	ORN-YEL
	BLU-YEL
	20
	LEFT KICKER SG23-900-DC
	ORN-GRN
	BLU-GRN
	21
	RIGHT KICKER SG23-900-DC
	ORN-BLU
	BLU-BLK
	22
	NOT USED
	ORN-VIO
	BLU-VIO
	RIGHT FLIPPER SFL-20-300/ 30-800-DC
	ORN-GRY
	BLU-GRY
	LEFT FLIPPER SFL-20-300/ 30-800-DC

SOLENOIDS PLAYFIELD CABINET

COIL →	GRY-BRN	BRN-BLK
	1	9
	BALL RELEASE SA-23-900-DC	10 PT SOUND
	GRY-RED	BRN-RED
	2	10
	LEFT CENTER DROP TARGET RESET SA3-23-900-DC	100 PT SOUND
	GRY-ORN	BRN-ORN
	3	11
	LEFT BANK BOTTOM DROP TARGET RESET SA3-23-900-DC	1,000 PT SOUND
	GRY-YEL	BRN-YEL
	4	12
	LEFT BANK TOP DROP TARGET RESET SA3-23-900-DC	10,000 SOUND
	GRY-GRN	BRN-GRN
	5	13
	RIGHT BANK TOP DROP TARGET RESET SA3-23-900-DC	SOUND ALTERNATOR
	GRY-BLU	BRN-BLU
	6	14
	RIGHT BANK BOTTOM DROP TARGET RESET SA3-23-900-DC	CREDIT KNOCKER SA2-23-900-DC
	GRY-VIO	BRN-VIO
	7	15
	RIGHT CENTER DROP TARGET RESET SA3-23-900-DC	NOT USED
	GRY-BLK	BRN-GRY
	8	16
	NOT USED	COIN LOCKOUT SM-35-4000-DC

Figure 10. PHOENIX Solenoids

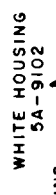

FEMALE

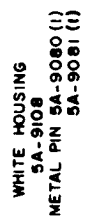
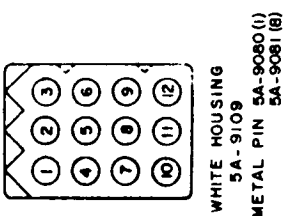
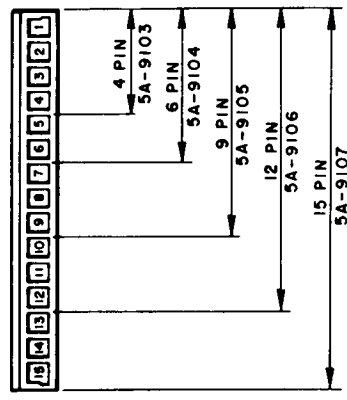

FEMALE

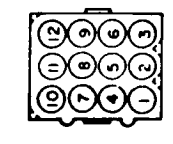
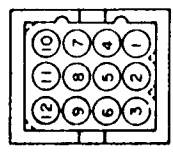
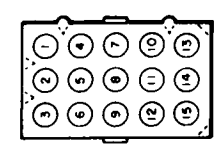
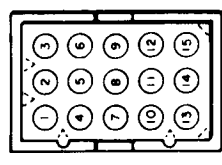
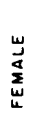
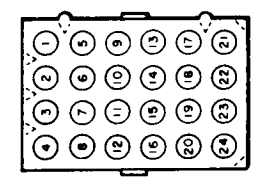
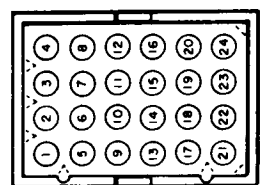
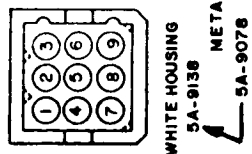
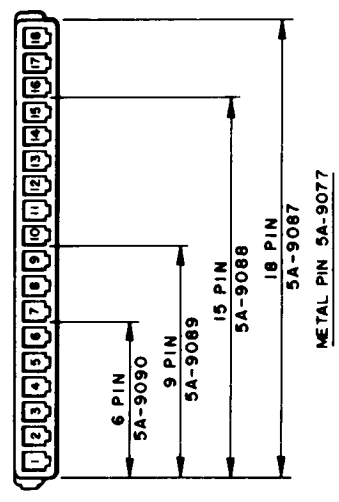

Figure 11. Connector Details

CPU BOARD

Pin	Wire Color	Function
1J1 - INTERBOARD CONNECTOR		
1P2 - LOGIC POWER BUS INPUT		
1	Black	Logic Ground
2	Black	Logic Ground
3	Black	Logic Ground
4	Gray	Logic B + (+5 VDC)
5	Gray	Logic B + (+5 VDC)
6	Gray	Logic B+ (+5 VDC)
7	Key	Key
8	N/C	Not Used
9	Gray-White	Logic B+ (+12 V) (Unregulated)

1P3 - DISPLAY BLANKING

1	N/C	Not Used
2	N/C	Not Used
3	Key	Key
4	Blue-White	Display Blanking

1P4 - DIAGNOSTIC SWITCH INPUTS

1	Key	Key
2	White	Diagnostic Common
3	Green	Diagnostic Advance
4	Blue	Diagnostic Auto/Man.

1P5 - MASTER DISPLAY BCD OUTPUTS

1	Blue-Yellow	Display BCD D1
2	Blue-Orange	Display BCD C1
3	Blue-Red	Display BCD B1
4	Blue-Brown	Display BCD A1
5	Blue-Gray	Display BCD D2
6	Key	Key
7	Blue-Violet	Display BCD C2
8	Blue-Black	Display BCD B2
9	Blue-Green	Display BCD A2

1P6 - MASTER DISPLAY STROBE OUTPUTS

1	Violet-Gray	Display Strobe #16
2	Violet-Black	Display Strobe #15
3	Violet-Blue	Display Strobe #14
4	Violet-Green	Display Strobe #13
5	Violet-Yellow	Display Strobe #12
6	Violet-Orange	Display Strobe #11
7	Key	Key
8	Violet-Red	Display Strobe #10
9	Violet-Brown	Display Strobe # 9

1P7 - MASTER DISPLAY STROBE OUTPUTS

1	Brown-Gray	Display Strobe # 8
2	Brown-Violet	Display Strobe # 7
3	Brown-Blue	Display Strobe # 6
4	Brown-Green	Display Strobe # 5
5	Brown-Yellow	Display Strobe # 4
6	Brown-Orange	Display Strobe # 3
7	Brown-Red	Display Strobe # 2
8	Key	Key
9	Brown-Black	Display Strobe # 1

DRIVER BOARD

Pin	Wire Color	Function
2P1 - INTERBOARD CONNECTOR		
2P2 - SWITCH COLUMN DRIVE		
1	Green-Gray	Not Used
2	Green-Violet	Not Used
3	Green-Blue	Switch Column # 6
4	Key	Key
5	Green-Black	Switch Column # 5
6	Green-Yellow	Switch Column # 4
7	Green-Orange	Switch Column # 3
8	Green-Red	Switch Column # 2
9	Green-Brown	Switch Column # 1

2P3 - SWITCH ROW INPUTS

1	White-Gray	Switch Row # 8
2	Key	Key
3	White-Violet	Switch Row # 7
4	White-Blue	Switch Row # 6
5	White-Green	Switch Row # 5
6	White-Yellow	Switch Row # 4
7	White-Orange	Switch Row # 3
8	White-Red	Switch Row # 2
9	White-Brown	Switch Row # 1

2P4 - LAMP POWER BUS

1	Blue	Lamp B+
2	Blue	Lamp B+
3	Key	Key
4	Blue	Lamp B+
5	Blue	Lamp B+
6	N/C	Not Used
7	Blue	Lamp B+
8	Blue	Lamp B+
9	Blue	Lamp B+

2P5 - LAMP COLUMN DRIVE

1	Yellow-Violet	Lamp Column # 7
2	Yellow-Gray	Lamp Column # 8
3	Yellow-Green	Lamp Column # 5
4	Key	Key
5	Yellow-Blue	Lamp Column # 6
6	Yellow-Orange	Lamp Column # 3
7	Yellow-Black	Lamp Column # 4
8	Yellow-Brown	Not Used
9	Yellow-Red	Lamp Column # 2

2P6 - LAMP GROUNDS

1	Black	Lamp Ground
2	Key	Key
3	Black	Lamp Ground
4	Black	Lamp Ground
5	N/C	Not Used
6	Black	Lamp Ground
7	Black	Lamp Ground
8	Black	Lamp Ground
9	Black	Lamp Ground

DRIVER BOARD (con't)

Pin	Wire Color	Function
2P7 - LAMP ROW DRIVE		
1	Red-Brown	Lamp Row # 1
2	Red-Black	Lamp Row # 2
3	Red-Orange	Lamp Row # 3
4	Red-Yellow	Lamp Row # 4
5	Red-Green	Lamp Row # 5
6	Red-Blue	Lamp Row # 6
7	Key	Key
8	Red-Gray	Lamp Row # 8
9	Red-Violet	Lamp Row # 7

2P8 - LOGIC POWER BUS INPUT

1	Black	Logic Ground
2	Black	Logic Ground
3	Black	Logic Ground
4	Black	Logic Ground
5	Key	Key
6	Gray	Logic B+ (+5 VDC)
7	Gray	Logic B+ (+5 VDC)
8	Gray	Logic B+ (+5 VDC)
9	Gray	Logic B+ (+5 VDC)

2P9 - CABINET SOLENOIDS DRIVE

1	Brown-Orange	1,000 Point Sound (11)
2	Brown-Yellow	10,000 Point Sound (12)
3	Brown-Green	Sound Alternator (13)
4	Brown-Blue	Not Used (15)
5	Brown-Violet	Credit Kicker (14)
6	Brown-Gray	Coin Lockout (16)
7	Brown-Red	100 Point Sound (10)
8	Key	Key
9	Brown-Black	10 Point Sound (9)

2P10 - SOLENOID GROUNDS

1	Black	Solenoid Ground
2	Black	Solenoid Ground
3	Black	Solenoid Ground
4	Black	Solenoid Ground
5	Key	Key
6	N/C	Not Used
7	Black	Solenoid Ground
8	Black	Solenoid Ground
9	Black	Solenoid Ground

2P11 - PLAYFIELD SOLENOIDS DRIVE

1	Gray-Black	Not Used (8)
2	Gray-Violet	Right Center Drop Target Reset (7)
3	Gray-Blue	Right Bank, Bottom Drop Targets Reset
4	Gray-Brown	Ball Release (1)
5	Gray-Red	Left Center Drop Target Reset (2)
6	Key	Key
7	Gray-Orange	Left Bank, Bottom Drop Targets Reset (3)
8	Gray-Yellow	Left Bank, Top Drop Targets Reset (4)
9	Gray-Green	Right Bank, Top Drop Targets Reset (5)

DRIVER BOARD (con't)

Pin	Wire Color	Function
2P12 - SPECIAL SOLENOIDS DRIVE		
1	Orange-Violet	Right Flipper Enable
2	Orange-Gray	Left Flipper Enable
3	Blue-Orange	Right Jet Bumper Coil (19)
4	Blue-Red	Center Jet Bumper Coil (18)
5	Key	Key
6	Blue-Yellow	Left Kicker Coil (20)
7	Blue-Brown	Left Left Bumper Coil (17)
8	Blue-Green	Right Kicker Coil (21)
9	Blue-Black	Not Used (22)

2P13 - SPECIAL SWITCH INPUTS

1	Key	Key
2	Orange-Black	Right Jet Bumper Switch
3	Orange-Red	Center Jet Bumper Switch
4	Orange-Yellow	Left Kicker Switch
5	Orange-Brown	Left Jet Bumper Switch
6	N/C	Not Used
7	N/C	Not Used
8	Orange-Green	Right Kicker Switch
9	Orange-Blue	Not Used

POWER SUPPLY**3P1 - POWER BUS INPUTS**

1	Violet	Lamps (+18 VDC)
2	Orange	Solenoids (+28 VDC)
3	N/C	Not Used
4	White	90 VAC
5	N/C	Not Used
6	N/C	Not Used
7	N/C	Not Used
8	N/C	Not Used
9	White	90 VAC
10	Gray	18.7 VAC
11	Gray	18.7 VAC
12	Gray-White	18.7 VAC C.T.

3P2 - POWER BUS INPUTS

1	N/C	Not Used
2	N/C	Not Used
3	Black	Solenoid Rect.
4	N/C	Not Used
5	N/C	Not Used
6	Black	Lamp Rect.

3P3 - SOLENOID POWER BUS

1	N/C	Not Used
2	N/C	Not Used
3	Black	Ground
4	N/C	Not Used
5	N/C	Not Used
6	Red	Solenoid B+ (+28 VDC)
7	Red	Solenoid B+ (+28 VDC)
8	N/C	Not Used
9	Key	Key

NOTE: Number in parentheses () in 2P9, 2P11, and 2P12 function column is the solenoid number readout during test 02.

POWER SUPPLY (Con't.)

Pin	Wire Color	Function
3P4 - LAMP & SOLENOID POWER BUS		
1	Black	Ground
2	Black	Ground
3	Black	Ground
4	Black	Ground
5	Blue	Lamp B+ (+16 VDC)
6	Blue	Lamp B+ (+16 VDC)
7	Blue	Lamp B+ (+16 VDC)
8	Blue	Lamp B+ (+16 VDC)
9	Black	Ground
10	Black	Ground
11	Black	Ground
12	Black	Ground

Pin	Wire Color	Function
3P5 - DISPLAY POWER BUS		
1	Black	Ground
2	N/C	Not Used
3	Orange & Wht-Blk	-100 VDC
4	Brown	+100 VDC
5	Key	Key
6	Gray	Logic B+ (+5 VDC)

Pin	Wire Color	Function
3P6 - LOGIC POWER BUS		
1	N/C	Not Used
2	N/C	Not Used
3	N/C	Not Used
4	N/C	Not Used
5	Key	Key
6	Gray-White	Logic B+ (+12 V Un-regulated)
7	Gray	Logic B+ (+5 VDC)
8	Gray	Logic B+ (+5 VDC)
9	Gray	Logic B+ (+5 VDC)
10	Gray	Logic B+ (+5 VDC)
11	Black	Ground
12	Black	Ground
13	Black	Ground
14	Black	Ground
15	Black	Ground

MASTER DISPLAY

Pin	Wire Color	Function
4P1 - MASTER DISPLAY PLAYER #1		
1	Brown-Black	Units
2	Brown-Red	10's
3	Brown-Orange	100's
4	Brown-Yellow	1,000's
5	Brown-Green	10,000's
6	N/C	Key
7	Brown-Blue	100,000's
8	Brown	a
9	Red	b
10	Blue	f
11	Violet	g
12	Orange	c
13	Green	e
14	Yellow	d
15	White-Black	Cathode Keep Alive

MASTER DISPLAY

Pin	Wire Color	Function
4P2 - MASTER DISPLAY PLAYER #2		
1	White-Black	Cathode Keep Alive
2	Red-Black	Units
3	Red-Brown	10's
4	Red-Orange	100's
5	Red-Yellow	1000's
6	Yellow	d
7	Green	e
8	Orange	c
9	N/C	Key
10	Violet	g
11	Blue	f
12	Red	b
13	Brown	a
14	Red-Green	10,000's
15	Red-Blue	100,000's

Pin	Wire Color	Function
4P3 - MASTER DISPLAY PLAYER #3		
1	White-Black	Cathode Keep Alive
2	Orange-Yellow	100's
3	Orange-Green	1000's
4	N/C	Key
5	Orange-Blue	10,000's
6	Orange-Violet	100,000's
8	Orange-Brown	Units
9	Brown	a
10	Red	b
11	Blue	f
12	Violet	g
13	Orange	c
14	Green	e
15	Yellow	d

Pin	Wire Color	Function
4P4 - MASTER DISPLAY #4		
1	Yellow	d
2	Green	e
3	Orange	c
4	Violet	g
5	Blue	f
6	Red	b
7	Brown	a
8	Yellow-Brown	Units
9	Yellow-Red	10's
10	Yellow-Orange	100's
11	N/C	Key
12	Yellow-Green	1000's
13	Yellow-Blue	10,000's
14	Yellow-Violet	100,000's
15	White-Black	Cathode Keep Alive

MASTER DISPLAY**4P5 - MASTER DISPLAY STROBE INPUTS**

Pin	Wire Color	Function
1	N/C	Not Used
2	Brown-Gray	Strobe# 8
3	Brown-Violet	Strobe# 7
4	Violet-Gray	Strobe#16
5	Violet-Black	Strobe#15
6	Brown-Black	Strobe# 1
7	Brown-Red	Strobe# 2
8	Brown-Orange	Strobe# 3
9	Brown-Yellow	Strobe# 4
10	Brown-Green	Strobe# 5
11	Brown-Blue	Strobe# 6
12	Violet-Red	Strobe#10
13	Violet-Orange	Strobe#11
14	Violet-Blue	Strobe#14
15	Violet-Brown	Strobe# 9
16	Violet-Green	Strobe#13
17	Violet-Yellow	Strobe#12
18	N/C	Not Used

4P6 - MASTER DISPLAY BCD INPUTS

1	Blue-Red	B1
2	Blue-Orange	C1
3	Blue-White	Blanking
4	Blue-Yellow	D1
5	Blue-Brown	A1
6	Blue-Black	B2
7	Blue-Violet	C2
8	Blue-Gray	D2
9	Blue-Green	A2

4P7 - MASTER DISPLAY POWER INPUTS

1	White-Black	Keep Alive -100 VDC
2	Brown	+100 VDC
3	Gray	Logic B+ (+5 VDC)
4	N/C	Not Used
5	Black	Ground
6	Orange	-100 VDC

PLAYER DISPLAYS**5P1 - PLAYER #1 SLAVE DISPLAY**

1	Blue	f
2	Violet	g
3	Brown-Blue	100,000's
4	Green	e
5	Yellow	d
6	Brown-Green	10,000's
7	Brown-Yellow	1,000's
8	N/C	Not Used
9	Brown-White	Anode Keep Alive
10	White-Black	Cathode Keep Alive
11	Brown-Orange	100's
12	Brown-Red	10's
13	N/C	Key
14	Orange	c
15	Brown-Black	Units
16	Red	b
17	Brown	a
18	N/C	Not Used

PLAYER DISPLAYS (con't)**5P2 - PLAYER #2 SLAVE DISPLAY**

1	Blue	f
2	Violet	g
3	Red-Blue	100,000's
4	Green	e
5	Yellow	d
6	Red-Green	10,000's
7	Red-Yellow	1,000's
8	N/C	Not Used
9	Brown-White	Anode Keep Alive
10	White-Black	Cathode Keep Alive
11	Red-Orange	100's
12	Red-Brown	10's
13	N/C	Key
14	Orange	c
15	Red-Black	Units
16	Red	b
17	Brown	a
18	N/C	Not Used

5P3 - PLAYER #3 SLAVE DISPLAY

1	Blue	f
2	Violet	g
3	Orange-Violet	100,000's
4	Green	e
5	Yellow	d
6	Orange-Blue	10,000's
7	Orange-Green	1,000's
8	N/C	Not Used
9	Brown-White	Anode Keep Alive
10	White-Black	Cathode Keep Alive
11	Orange-Yellow	100's
12	Orange-Red	10's
13	N/C	Key
14	Orange	c
15	Orange-Brown	Units
16	Red	b
17	Brown	a
18	N/C	Not Used

5P4 - PLAYER #4 SLAVE DISPLAY

1	Blue	f
2	Violet	g
3	Yellow-Violet	100,000's
4	Green	e
5	Yellow	d
6	Yellow-Blue	10,000's
7	Yellow-Green	1,000's
8	N/C	Not Used
9	Brown-White	Anode Keep Alive
10	White-Black	Cathode Keep Alive
11	Yellow-Orange	100's
12	Yellow-Red	10's
13	N/C	Key
14	Orange	c
15	Yellow-Brown	Units
16	Red	b
17	Brown	a
18	N/C	Not Used

BACK BOX MISCELLANEOUS

Pin Color Function

6P1/6J1 - SWITCHED AC INPUT

1	White-Red	AC
2	N/C	
3	White-Red	AC

6P2/6J2 - FLIPPER POWER

1	White-Red	Flipper B+
---	-----------	------------

6P3/6J3 - SOUND BOARD POWER

1	Gray	18.7 VAC
2-4	N/C	Not Used
5	Gray-White	18.7 VAC C. T.
6-8	N/C	Not Used
9	Gray	18.7 VAC

CABINET

7P1/7J1 - CABINET SOLENOIDS & SWITCHES (White 36 Pin)

1	Yellow	6.3 VAC Display Lamps
2	Yellow-White	6.3 VAC Display Lamps
3	Red	Solenoid B+
4	White	Diagnostic Common
5	Green	Diagnostic Advance
6	Blue	Diagnostic Auto/Man.
7	Orange-Violet	Right Flipper Enable
8	Blue-Violet	Right Flipper Switch
9	Orange-Gray	Left Flipper Enable
10	Blue-Gray	Left Flipper Switch
11	Brown-Black	10 Point Sound (9)
12	Brown-Red	100 Point Sound (10)
13	Brown-Orange	1000 Point Sound (11)
14	Brown-Yellow	10,000 Point Sound (12)
15	Brown-Green	Sound Alternator (13)
16	Brown-Blue	Knocker (14)
17	Brown-Violet	Not Used
18	Brown-Gray	Coin Lockout (14)
19	Green-Brown	Switch Column # 1
20	N/C	Not Used
21	White-Brown	Switch Row # 1
22	White-Red	Switch Row # 2
23	White-Orange	Switch Row # 3
24	White-Yellow	Switch Row # 4
25	White-Green	Switch Row # 5
26	White-Blue	Switch Row # 6
27	White-Violet	Switch Row # 7
28	White-Gray	Switch Row # 8
29-36	N/C	Not Used

CABINET (con't)

Pin Color Function

7P2/7J2 - COIN DOOR (White-15 Pin)

1	Yellow	6.3 VAC Display Lamps
2	Yellow-White	6.3 VAC Display Lamps
3	Red	Coil B+
4	Brown-Gray	Coin Lockout (16)
5	N/C	Not Used
6	Green-Brown	Switch Column # 1
7	N/C	Not Used
8	White-Yellow	Switch Row # 4
9	White-Green	Switch Row # 5
10	White-Blue	Switch Row # 6
11	White-Violet	Switch Row # 7
12	White-Gray	Switch Row #8
13	White	Diagnostic Common
14	Green	Advance
15	Blue	Auto/Manual

PLAYFIELD

8P1/8J1 - PLAYFIELD SWITCHES (White-15 Pin)

1	Green-Red	Switch Column # 2
2	Green-Orange	Switch Column # 3
3	Green-Yellow	Switch Column # 4
4	Green-Black	Switch Column # 5
5	Green-Blue	Switch Column # 6
6	Green-Violet	Not Used
7	Green-Gray	Not Used
8	White-Brown	Switch Row # 1
9	White-Red	Switch Row # 2
10	White-Orange	Switch Row # 3
11	White-Yellow	Switch Row # 4
12	White-Green	Switch Row # 5
13	White-Blue	Switch Row # 6
14	White-Violet	Switch Row # 7
15	White-Gray	Switch Row # 8

NOTE: Number in parentheses () in 7P1 and 7P2 function column is the solenoid number readout in test 02.

PLAYFIELD (con't)

Pin	Wire Color	Function
8P2/8J2 - PLAYFIELD LAMPS (White-24 Pin)		
1	Yellow	6.3 VAC Display
2	Yellow-White	6.3 VAC Display
3	Yellow-Brown	Lamp Column # 1
4	Yellow-Red	Lamp Column # 2
5	Yellow-Orange	Lamp Column # 3
6	Yellow-Black	Lamp Column # 4
7	Yellow-Green	Lamp Column # 5
8	Yellow-Blue	Lamp Column # 6
9	Yellow-Violet	Lamp Column # 7
10	N/C	Not Used
11	Red-Brown	Lamp Row # 1
12	Red-Black	Lamp Row # 2
13	Red-Orange	Lamp Row # 3
14	Red-Yellow	Lamp Row # 4
15	Red-Green	Lamp Row # 5
16	Red-Blue	Lamp Row # 6
17	Red-Violet	Lamp Row # 7
18	Red-Gray	Lamp Row # 8
19-24	N/C	Not Used
8P3/8J3 - PLAYFIELD SOLENOIDS, SPECIAL SWITCHES (Black) (24 Pin)		
1	Red	Coil B+
2	Black	Ground (Special Switch Common)
3	Blue-Violet	Right Flipper Coil
4	Blue-Gray	Left Flipper Coil
5	Orange-Brown	Left Jet Bumper Switch
6	Orange-Red	Center Jet Bumper Switch
7	Orange-Black	Right Jet Bumper Switch
8	Orange-Yellow	Left Kicker Switch
9	Orange-Green	Right Kicker Switch
10	Orange-Blue	Not Used
11	Blue-Brown	Left Jet Bumper Coil (17)
12	Blue-Red	Center Jet Bumper Coil (18)
13	Blue-Orange	Right Jet Bumper Coil (19)
14	Blue-Yellow	Left Kicker Coil (20)
15	Blue-Green	Right Kicker Coil (21)
16	Blue-Black	Not Used (22)
17	Gray-Brown	Ball Release (1)
18	Gray-Red	Left Center Drop Target Reset (2)
19	Gray-Orange	Left Bank, Bottom Drop Targets Reset (3)
20	Gray-Yellow	Left Bank, Top Drop Targets Reset (4)
21	Gray-Green	Right Bank, Top Drop Targets Reset (5)
22	Gray-Blue	Right Bank, Bottom Drop Targets Reset (6)
23	Gray-Violet	Right Center Drop Target Reset (7)
24	Gray-Black	Not Used (8)

NOTE: Number in parentheses () in 8P3 Function column is the solenoid number readout in test 02.

INSERT BOX

Pin	Color	Function
9P1/9J1 - INSERT DOOR LAMP CONNECTOR (Black-15 Pin)		
1	Yellow	6.3 VAC Display Lamps
2	Yellow-White	6.3 VAC Display Lamps
3	N/C	Not Used
4	Yellow	6.3 VAC Display Lamps
5	Yellow-White	6.3 VAC Display Lamps
6	Yellow-Violet	Lamp Column # 7
7	Yellow-Gray	Lamp Column # 8
8	Red-Brown	Lamp Row # 1
9	Red-Black	Lamp Row # 2
10	Red-Orange	Lamp Row # 3
11	Red-Yellow	Lamp Row # 4
12	Red-Green	Lamp Row # 5
13	Red-Blue	Lamp Row # 6
14	Red-Violet	Lamp Row # 7
15	Red-Gray	Lamp Row # 8

9P2/9J2 - PLAYER 1 KEEP ALIVE

1	Brown-White	Anode Keep Alive
---	-------------	------------------

9P3/9J3 - PLAYER 2 KEEP ALIVE

1	Brown-White	Anode Keep Alive
---	-------------	------------------

9P4/9J4 - PLAYER 3 KEEP ALIVE

1	Brown-White	Anode Keep Alive
---	-------------	------------------

9P5/9J5 - PLAYER 4 KEEP ALIVE

1	Brown-White	Anode Keep Alive
---	-------------	------------------

SOUND BOARD**10P1/10J1 - POWER INPUTS**

1	Gray	18.7 VAC
2-4	N/C	Not Used
5	Gray-White	18.7 VAC C.T.
6	N/C	Not Used
7	Key	Key
8	N/C	Not Used
9	Gray	18.7 VAC

10P2/10J2 - SPEAKER OUTPUT

1	N/C	Not Used
2	Red	Speaker +
3	Black	Speaker Com
4	N/C	Not Used

10P3/10J3 - SOUND SELECT INPUTS

1	Key	Key
2	Brown-Red	100 Point Sound (10)
3	Brown-Black	10 Point Sound (9)
4	Brown-Yellow	10,000 Point Sound (12)
5	Brown-Orange	1,000 Point Sound (11)
6	N/C	Not Used
7	N/C	Not Used
8	Brown-Green	Sound Alternator (13)
9	N/C	Not Used

SECTION 8 MECHANICAL ADJUSTMENTS

SWITCHES

There are different types of switches used throughout the game. The switch blades are made of a highly conductive spring type metal in various lengths, thickness, and form. Each switch is designed to satisfy specific operation conditions such as bounce, current carrying capacity, speed of operation, etc. Therefore, it is important to replace a blade with another of the same kind. When adjusting blades, never kink or bend sharply, as this causes fatigue which leads to fractures. Adjust blades with a sweeping, bowing motion, with a switch adjusting tool or duck bill pliers.

When switch adjustments are called for, before forming blades on any machine, check that the screws holding the switch stacks are down very tight. This is recommended because plastic spacers in the switch stacks will occasionally shrink by drying out causing a poor adjustment.

With the exception of a few instances, all blade type switches should have at least 1/32 inch between the contact points and should follow thru for at least 1/32 inch beyond the point at which the contacts close. This follow thru action provides a wiping motion between the contacts keeping them clean and insuring good contact between the points.

To adjust blade type switches properly, first adjust the actuating blade (usually, the longer one) with relation to the part that it contacts. Then set the gap and follow thru by adjusting the other blade.

SWITCH CONTACTS

With the exception of flipper button and end of stroke switches, all blade switch contacts are gold-plated and must NOT be burnished or filed. To clean the contacts, close them on a clean piece of paper (e.g. business card) and wipe gently until the contacts are clean.

For the flipper button switches, remove tarnish by filing with a contact file and then burnishing. Do the same for the flipper end-of-stroke switch contacts.

DO NOT file or burnish any other contacts.

Severely pitted contacts should be replaced as an assembly. Switch contacts should only be adjusted when they cause a malfunction or do not score properly.

ROLL-OVER LANE SWITCHES

Playfield lane switches are operated by a roll-over wire form which is actuated by the ball. Before the switch is adjusted, the wire should be centered in the playfield slot. The long blade closest to the playfield should be adjusted to hold the wire form up. Check this condition with the playfield down. Then, with the playfield up, adjust the short blade for 1/16 inch clearance. Depress the wire form to its maximum depression with the ball and check for 1/32 inch follow thru. To prevent switch vibration a back-up blade is used. It should be parallel and just barely in contact with the short blade.

FLIPPER

Flippers are controlled by the flipper pushbuttons at each side of the cabinet. The flipper coil consists of two wind-

ings: A pull-in winding and a lighter gauge hold-in winding. The hold-in winding is normally bypassed by a closed switch.

The pull-in winding produces a strong stroke. However, if this winding were to remain energized by the player it would overheat. To reduce this high current, the hold winding is put in series with the pull-in winding by opening the end-of-stroke switch.

This switch should be adjusted so that the long blade is moved by the flipper pawl assembly for about the last 1/8 inch of movement. With the plunger completely depressed manually, both switches should be adjusted for a 3/32 inch gap. The short blade should have a 1/32 inch follow thru.

NEVER LUBRICATE THE PLUNGER. The only lubrication required is the link assembly with the special coin machine lubricant.

Weak or sluggish flipper action can be due to dirty or improperly adjusted contact points, worn out coil sleeve, loose or broken bushing, incorrect coil or shorted diodes, worn out fiber links, weak or broken return spring, loose coil between the retaining bracket and coil stop, or loose screws. Check all of the above to correct.

PLUMB BOB TILT

The plumb bob tilt can be made sensitive by raising the plumb bob on the shaft. It can also be made less sensitive by lowering the bob on the shaft.

SUPER SLAM TILT

The super slam tilt on the coin door is adjustable. The normal adjustment is contacts open 1/32 inch.

PLAYFIELD TILT

The playfield tilt is adjustable by forming the switch contacts. Closing the gap will make the tilt more sensitive.

ROLL TILT

The roll tilt in the cabinet box can be raised (more sensitive) or lowered (less sensitive) at the front pivot slot.

SECTION 9 SPARE PARTS

The parts used on the solid state CONTACT are standard Williams parts. Refer to Figure 12 for identification of various playfield parts and adjustments.

PLAYFIELD CARE

The playfield on this machine has an improved finish with excellent wearing properties. **DO NOT** clean the board with water, water soap solutions, or harsh abrasives. Avoid using steel wool, kitchen cleansers, or abrasive hand soap. Water will weaken the adhering of the paint to the board and abrasives shorten the board life.

A wax base cleaner with negligible abrasive qualities used lightly, but frequently, will extend board life to its full capabilities.

BACKGLASS REMOVAL

Unlock the key lock (Figure 1, - No. 4) then lift the glass up and out.

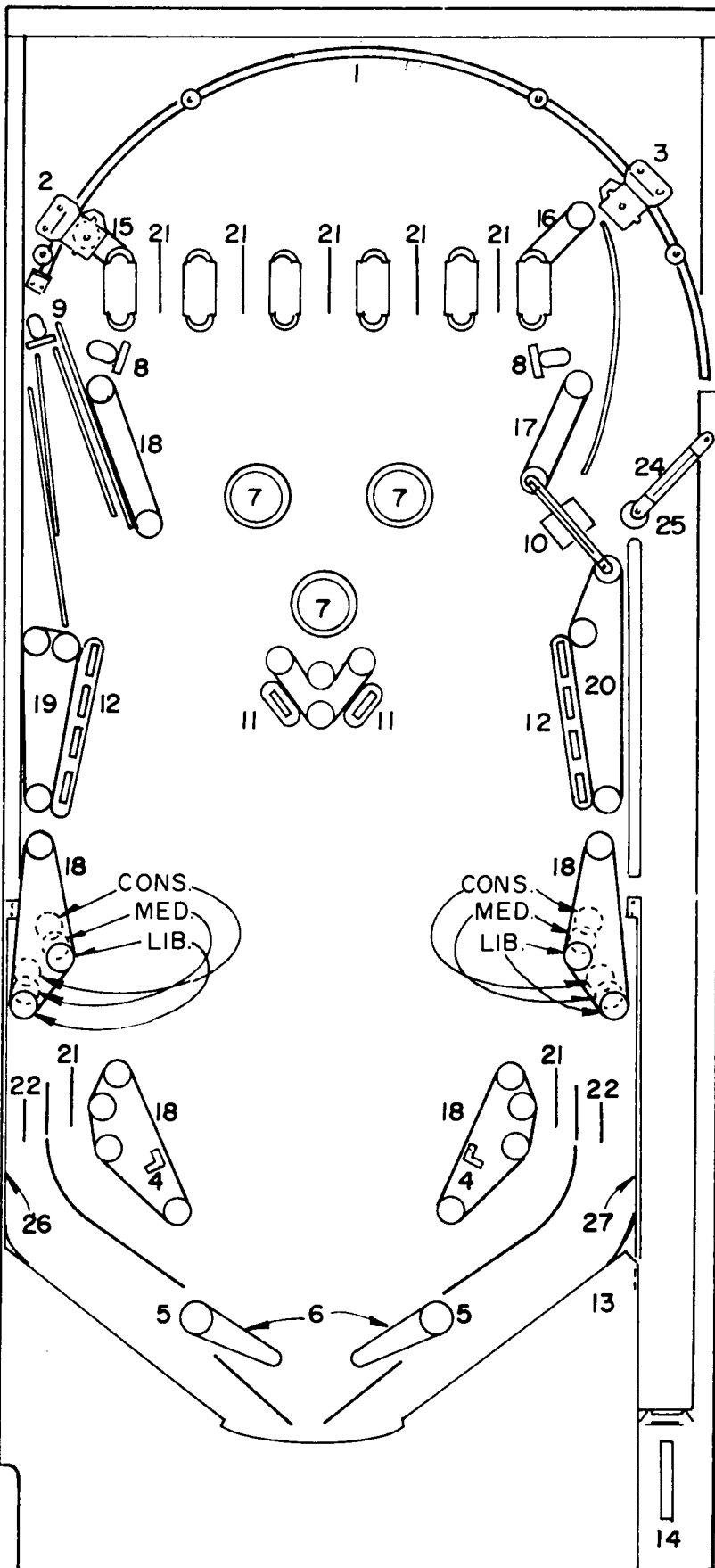

PHOENIX PARTS

PART NUMBER	DESCRIPTION
1. 2D-4004	TOP ARCH ROD
2. A-8096-L	LEFT BALL GATE
3. A-8096-R	RIGHT BALL GATE
4. B-8055	BALL KICKER ASSY.
5. B-7060	FLIPPER ASSY.
6. 23A-6519	FLIPPER RUBBER
7. B-7894	JET BUMPER ASSY.
8. A-8046	STATIONARY TARGET ASSY.
9. A-8100	STATIONARY TARGET ASSY.
10. B-7875	SPINNING TARGET ASSY.
11. D-7931-1S	DROP TARGET ASSY.
12. D-7931-4S	DROP TARGETS ASSY.
13. D-7473	BOTTOM ARCH ASSY.
14. 30B-7573	BALL SHOOTER GAUGE PLATE
15. 23A-6302	RUBBER RING 1" I.D.
16. 23A-6303	RUBBER RING 1-1/4" I.D.
17. 23A-6304	RUBBER RING 1-1/2" I.D.
18. 23A-6305	RUBBER RING 2" I.D.
19. 23A-6306	RUBBER RING 2-3/8" I.D.
20. 23A-6307	RUBBER RING 2-7/8" I.D.
21. A-5844-8	ROLLOVER WIRE ASSY.
22. A-5844-9	ROLLOVER WIRE ASSY.
23. 30C-485	PLAYFIELD PLASTICS-SET OF 8
24. 1A-3206	GATE MOUNTING BRACKET
25. 12A-6460	ANTI-RETURN BALL GATE
26. B-7537-L	BALL GUIDE ASSY.—LEFT
27. B-7537-R	BALL GUIDE ASSY.—RIGHT

POST ADJUSTMENTS

To make game more conservative or liberal, move post 3/16" as shown in sketch. Spotting holes are provided and can be seen upon removal of posts.

SUGGESTED SCORE CARDS

CREDIT GAMES

- 3 Ball 16C-485-12-SS
or 16C-485-25-SS
- 5 Ball 16C-485-48-SS

EXTRA BALLS

- 3 Ball 16C-485-58-SS
- 5 Ball 16C-485-63-SS

Figure 12. PHOENIX Spare Parts Identification and Post Adjustment Details