

Thank you for purchasing the Minolta QuickScan 35. The QuickScan 35 enables you to scan both negative and positive, color and monochrome (black & white) 35mm film using the Macintosh.

The main features of the QuickScan 35 are as follows:

- High-speed scanning with 3-line sensors
- High-quality images with a maximum of 2820 dpi
- Easy, versatile software

The Minolta QuickScan 35 is packaged with an Adobe Photoshop plug-in software and an independent Utility software. Before beginning to use the QuickScan 35, you should have a working knowledge of the Macintosh and its operating conventions. You should know how to use the mouse and standard Macintosh menus and commands.

Adobe Photoshop™ is a registered trademark of Adobe Systems Inc.

Macintosh™ is a registered trademark of Apple Computer, Inc.

Other corporate names and product names are also registered trademarks

Changes or modifications not approved by the party responsible for compliance could void the user's authority to operate the equipment.

This equipment has been tested and found to comply with the limits for a Class B digital device, pursuant to Part 15 of the FCC rules. These limits are designed to provide reasonable protection against harmful interference in a residential installation. This equipment generates, uses and can radiate radio frequency energy and, if not installed and used in accordance with the instructions, may cause harmful interference to radio communications. However, there is no guarantee that interference will not occur in a particular installation. If this equipment does cause harmful interference to radio or television reception, which can be determined by turning the equipment off and on, the user is encouraged to try to correct the interference by one or more of the following measures:

- Reorient or relocate the receiving antenna.
- Increase the separation between the equipment and receiver.
- Connect the equipment into an outlet on a circuit different from that to which the receiver is connected.
- Consult the dealer or an experienced radio/TV technician for help.

END-USER LICENSE AGREEMENT

CAREFULLY READ THE LICENSE AGREEMENT BELOW BEFORE OPENING THIS PACKAGED SOFTWARE. OPENING THIS PACKAGE INDICATES YOUR ACCEPTANCE TO THE TERMS AND CONDITION BELOW. IF YOU DO NOT AGREE WITH THEM YOU SHOULD PROMPTLY RETURN THE PACKAGE UNOPENED.

This is a license agreement and not an agreement for sale. Minolta owns, or has been licensed from other owners, copyrights in the computer programs ("Software"). You obtain no rights to the intellectual property in the Software other than the license granted to you regarding the Software under this agreement. The title to the enclosed copy of the copy the Software and any copy made from it is retained by Minolta or such other owners.

1. LICENSE

You may:

- (1) install and use the Software on only one computer at any one time.
- (2) make a copy of the Software for backup or installation purposes only in support of the normal and intended use of the Software.
- (3) transfer possession of copies of the Software to another party by transferring a copy of this Agreement and all other documentation along with at least one complete unaltered copy of the Software, provided that (i) you must, at the same time, either transfer to such other party or destroy all your other copies of the Software. (ii) Such transfer of possession terminates you license from Minolta, and (iii) such other party shall accept and be bound by these license terms by their initial use of the Software.

2. RESTRICTIONS

You shall not without the written consent of Minolta:

- (1) use, copy, modify, merge or transfer copies of the Software except as provided herein.
- (2) reverse assemble or reverse compile the Software except as permitted by law; or
- (3) sublicense, rent, lease or distribute the Software or any copy thereof.

3. LIMITED WARRANTY

Minolta warrants the media on which the Software is recorded to be free from defects in materials and workmanship under normal use. Warranty details and limitations for the Software are described in the Statement of Limited Warranty which is supplied with the hardware. With the exception of the foregoing express warranties applicable to hardware and media only, the Software is not warranted and is provided "AS IS".

SUCH WARRANTIES ARE IN LIEU OF ALL OTHER WARRANTIES, EXPRESSED OR IMPLIED, INCLUDING, BUT NOT LIMITED TO, THE IMPLIED WARRANTIES OF MERCHANTABILITY AND FITNESS FOR A PARTICULAR PURPOSE.

4. LIMITATION OF REMEDIES

In no event with Minolta be liable for any lost profits, lost saving, or any incidental damages that result from the use or inability to use the Software, even if Minolta or its Authorized remarketers have been advised of the possibility of such damages or for any claim by you based on a third party claim.

5. TERMINATION

You may terminate your license at any time by destroying the Software and all your copies of it or as otherwise described in these terms.

Minolta may terminate your license if you fail to comply with these terms. Upon such termination, you agree to destroy all your copies of the Software.

6. GOVERNING LAW

This Agreement shall be governed by the laws of the country where the delivery is made to the original customer.

7. GOVERNMENT END USERS

If you are acquiring the Software on behalf of any unit or agency of the United States Government, the following provisions apply. The Government agrees: (i) if the Software is supplied to the Department of Defense (DoD), the Software is classified as "Commercial Computer Software) and the Government is acquiring only "restricted right" in the Software as that term is defined in Clause 252.227.7013(c)(1) of the DFARS; and (ii) if the Software is supplied to any unit or agency of the United States Government other than DoD, the Government's rights in the Software will be as defined in Clause 52.227-19(c)(2) of the FAR or, in the case of NASA, in Clause 18-52.227-86(d) of the NASA Supplement to FAR

FOR PROPER AND SAFE USE

Various symbols are used throughout this instruction manual and on the product itself for your proper and safe use of this product, and to prevent personal injury, injury to others, or property damage. An explanation of the symbols follows. Read and understand each caution thoroughly before reading this main text of this instruction manual.



Disregard to this warning may result in death or injury.



Disregard to this caution may result in injury or property damage.

Examples



The outer triangle is for warning, and the symbol inside illustrates what is being warned.

The example at left means beware of electric shock.





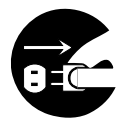









The circle with a diagonal slash is for prohibition (“don’t do”), and the symbol inside illustrates what act is prohibited. The example at left means do not disassemble.



The blue circle indicates something you must do, and the symbol inside illustrates how it should be done. The example at left means you must hold the plug when removing it from the outlet.

 **WARNING**

 	<p>RISK OF FIRE OR ELECTRIC SHOCK Do not use voltage other than what is indicated.</p>	
	<p>RISK OF FIRE OR ELECTRIC SHOCK Do not place a container of water or other liquid on the product. If water or other liquid gets inside the product, it may cause a short resulting in fire or electric shock. Immediately unplug, discontinue use, and contact a Minolta Service facility.</p>	 
	<p>RISK OF FIRE OR ELECTRIC SHOCK Do not insert small metal objects into the product. This may cause a short resulting in fire or electric shock. Immediately unplug, discontinue use, unplug, and contact a Minolta Service facility.</p>	 
	<p>RISK OF FIRE OR ELECTRIC SHOCK Do not misuse the power cord. Damage to the cord may result in fire or electric shock. Do not perform any of the following acts to the cord:</p> <ul style="list-style-type: none"> • Scratch • Pull • Twis • Heat • Modify • Place a heavy object on • Bend 	
	<p>RISK OF FIRE OR ELECTRIC SHOCK Do not use the product if there is smoke, a strange smell, or under any other unusual conditions. Use under these conditions may result in fire or electric shock. Immediately unplug, discontinue use, and contact a Minolta Service facility.</p>	 
	<p>RISK OF FIRE Do not place the product in dusty or very humid area.</p>	
	<p>RISK OF FIRE This product must have sufficient ventilation while in use. If the ventilation ducts are blocked, the temperature of the interior may become hot to the extent that fire will occur. Do not perform the following:</p> <ul style="list-style-type: none"> • Place the product on its side or upside down. • Place the product in a closet, on a shelf, or any area without sufficient ventilation. • Place the product on a carpet or mattress. • Cover the product 	

⚠ CAUTION















	<p>RISK OF FIRE OR ELECTRIC SHOCK Grasp the plug when removing the power cord from an outlet. Pulling the cord may damage it resulting in fire or electric shock.</p>	
	<p>RISK OF FIRE OR ELECTRIC SHOCK Do not connect the ground to the following:</p> <ul style="list-style-type: none"> • Gas pipe • Telephone ground • Water pipe 	
	<p>RISK OF ELECTRIC SHOCK Do not touch the power cord with wet hands.</p>	
	<p>RISK OF ELECTRIC SHOCK Do not attempt to disassemble this product. It contains high-voltage circuits. For repairs, contact a Minolta Service facility.</p>	
	<p>RISK OF ELECTRIC SHOCK Connect the ground before use. If the ground is not connected, an electricity leak may result in electric shock.</p>	
	<p>RISK OF INJURY Do not place of the product on an unstable surface.</p>	
	<p>RISK OF INJURY Do not sit on, stand on, or push against this product. Also, use caution when using near children.</p>	

TABLE OF CONTENTS

INTRODUCTION	1
END-USER LICENSE AGREEMENT	2
FOR PROPER AND SAFE USE	3
TABLE OF CONTENTS	6
BEFORE YOU BEGIN	7
1. Package Contents	7
2. System Requirements	7
NAMES OF PARTS	8
1.SCANNER	8
2.PREVIEW SCAN WINDOW	9
GETTING STARTED	10
1. SETTING THE SCSI ID NUMBER	10
2. CONNECTING THE SCANNER	11
3. INSTALLING THE SOFT WARE	12
4.SCAN FLOW CHART	13
SCANNING IMAGES	14
1. START UP	14
2.INSERTING THE FILM	16
2.1. Film Strip	16
2.2. Slide Mount	16
3. SPECIFYING THE FILM TYPE	17
4. PREVIEW THE IMAGE	17
5.SCAN SETTING	18
5.1. Image Orientation Button	18
5.2. Film Button	18
6. SELECTING THE SCAN MODE	18
6.1. Standard Mode	19
6.2. Pixel Mode	20
6.3. Print Mode	21
7. SCANNING THE IMAGE	22
8. SAVING THE FILE	22
9. EJECTING THE FILM	22
IMAGE ADJUSTMENT	23
1. COLOR BALANCE ADJUSTMENT	23
2. BLACK LEVEL ADJUSTMENT	23
3. BRIGHTNESS ADJUSTMENT	24
4. RESET	24
5. RGB/CMY LEVEL CHECKER	24
MANUAL FOCUS	25
SAVE/LOAD SETTINGS BUTTONS	26
1. SAVE	26
2. LOAD	26
FLUORESCENT LAMP AUTOMATIC SHUT OFF	26
COLOR SYNC	27
1. INSTALLATION	27
2. OPERATION	28
TROUBLE SHOOTING	29
SPECIFICATIONS	30

BEFORE YOU BEGIN

1. Package Contents

The following contents should be included in this package.

- QuickScan 35
- SCSI cable SC-1
- Power cord
- SCSI terminator ST-1
- QuickScan 35 Control for Macintosh
- Instruction manual
- Warranty card

2. System Requirements

To use the QuickScan 35 with the Macintosh, you need the following:

- Macintosh or Power Macintosh computer with a 68030 processor with a minimum of 25MHz
- Apple system software 7.1 or higher
- A minimum of 12 megabytes (MB) of application random-access memory (RAM) with a non-Power Macintosh
(If the Photoshop plug-in software is used, additional memory is required)
- A minimum of 20MB of application RAM with a Power Macintosh
(If the Photoshop plug-in software is used, additional memory is required)
- The Utility software requires a minimum of 8MB of RAM
- Set 32 bit in the memory control panel, virtual memory to OFF, modem memory manager to OFF, and file share to OFF
- Photoshop Version 2.5 or higher is required to use the Photoshop plug-in software

NAMES OF PARTS

1. SCANNER

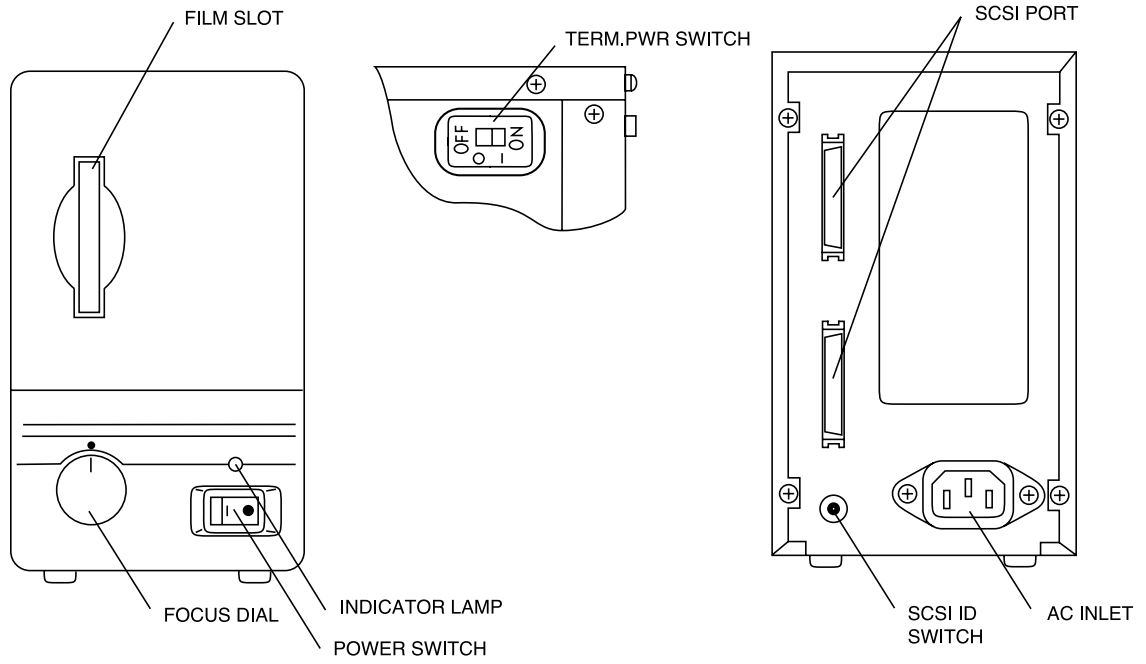

PREVIEW SCAN WINDOW

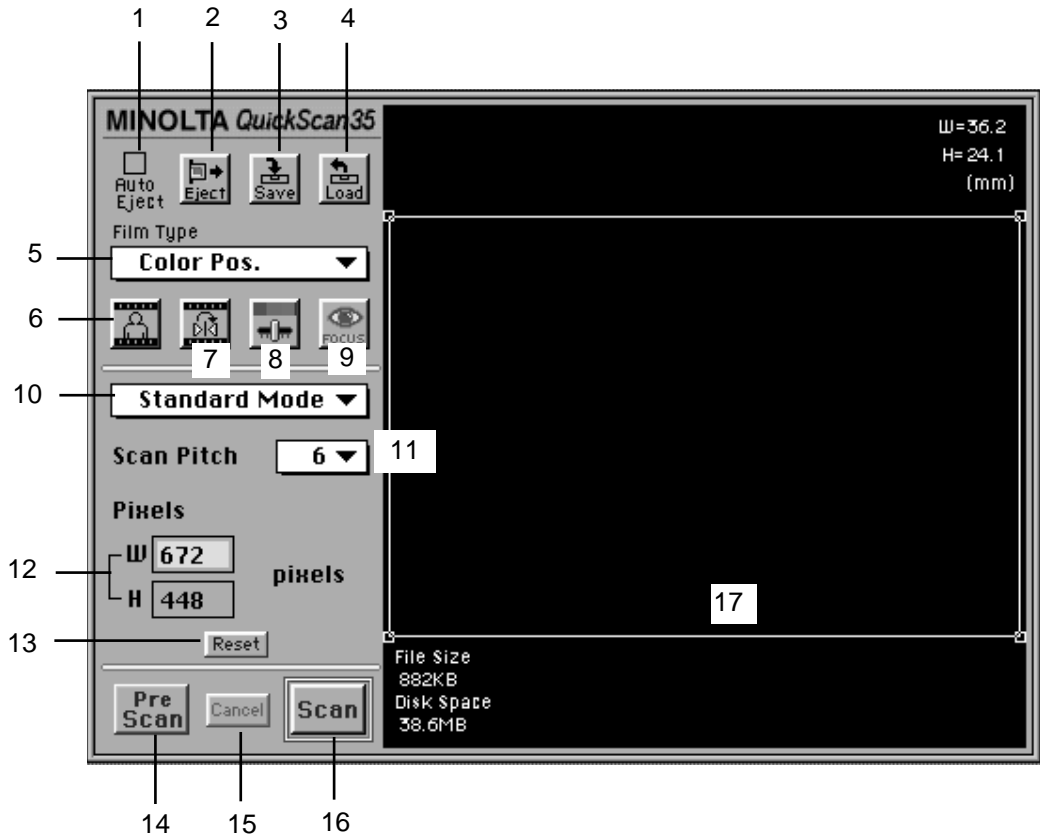

- | | |
|-----------------------------|----------------------------|
| 1. Auto eject check box | 10. Scan mode pop-up menu |
| 2. Film eject button | 11. Scan pitch pop-up menu |
| 3. Save button | 12. Pixel box |
| 4. Load button | 13. Reset button |
| 5. Film type pop-up menu | 14. Preview scan button |
| 6. Image orientation button | 15. Cancel button |
| 7. Flip button | 16. Scan button |
| 8. Image adjustment button | 17. Marquee |
| 9. Focus button | |

GETTING STARTED

1. SETTING THE SCSI ID NUMBER

You will need to set an SCSI identification (ID) number for the scanner. Each SCSI device connected to your computer must have a different SCSI ID number. Your Macintosh uses number 7, the internal hard disk uses number 0, and the internal CD-ROM uses number 3. These numbers cannot be used. Also, determine the SCSI ID number of any other SCSI device attached to your computer and avoid setting these numbers as well. Please note that the Macintosh has an SCSI ID number range of 0 to 7; therefore, if you set the scanner ID switch to 8 or 9, the computer will recognize it as 6.

1. Turn off the QuickScan 35. You cannot change the SCSI ID number while the power is on.
2. Select a number which is not used by any other SCSI device connected to your Macintosh computer, for example a hard disk.
3. Turn the SCSI ID switch located on the rear of the scanner to the appropriate ID number.

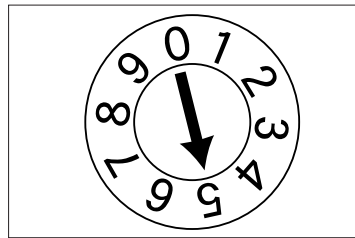

- If you are using the PowerBook or PowerBook Duo series computer, set TERM.PWR switch to ON.

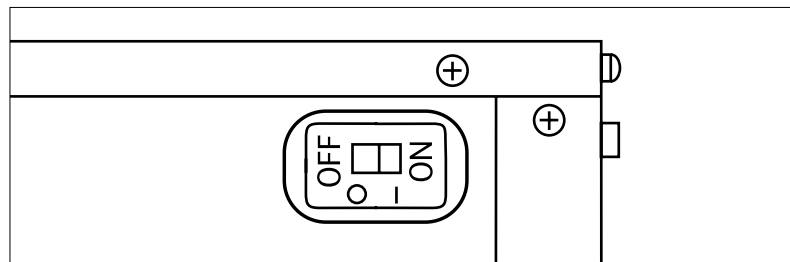

2. CONNECTING THE SCANNER

1. Connect one end of the SCSI cable to one of the two SCSI ports on the rear panel of the QuickScan 35 and the other end to the SCSI port on the rear of the Macintosh.
2. If the QuickScan 35 is the sole SCSI device, insert the SCSI terminator to the open port on the rear of the scanner.
 - ∞ If another SCSI device is connected, refer to its instruction manual.
3. Plug in one end of the power cord to the scanner's AC inlet and the other end to an outlet.

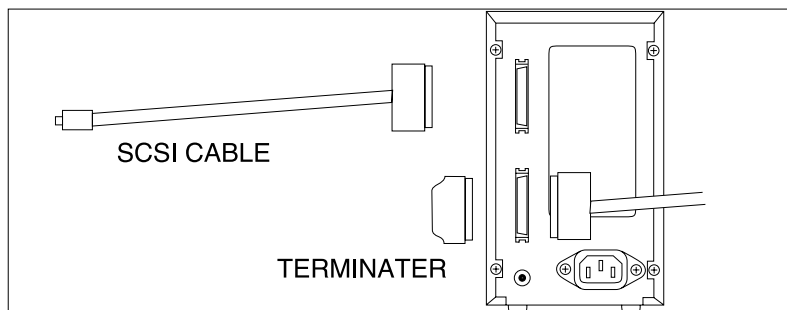
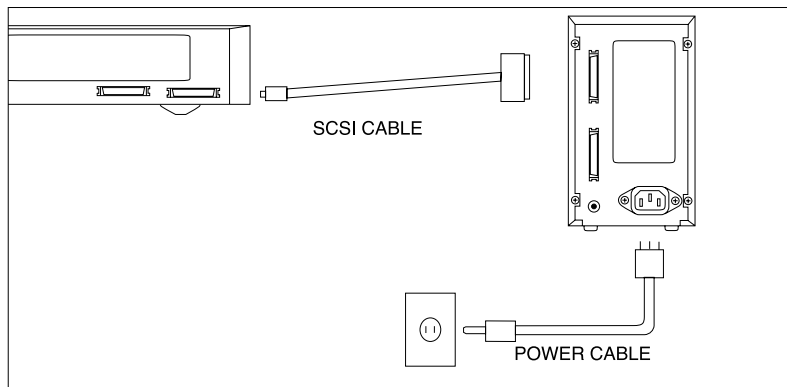

3. INSTALLING THE SOFTWARE

The QuickScan 35 comes with Photoshop Plug-in software and Utility software. If you do not have Photoshop or if you want to scan film using a fixed file size, use the Utility software.

1. Insert the QuickScan 35 disk to the Macintosh.
2. Double click of the disk icon.

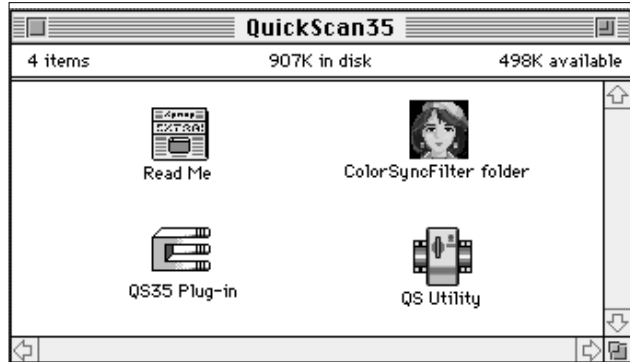

3. To install Photoshop Plug-in software, drag the Photoshop Plug-in icon into your Adobe Photoshop plug-ins folder. If you have Photoshop Version 3.0, drag the icon into the input/output folder of the plug-ins folder.

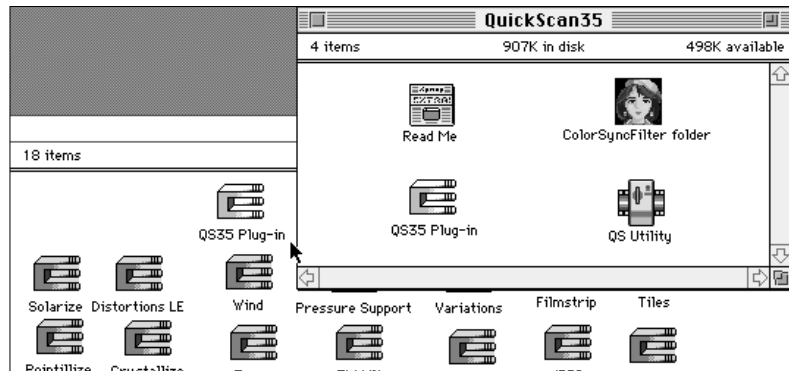

To install the Utility software, drag the Utility icon into the Macintosh hard drive folder.

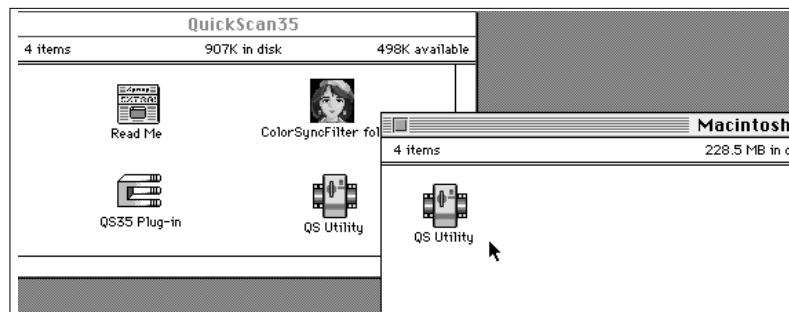

5. SCAN FLOW CHART

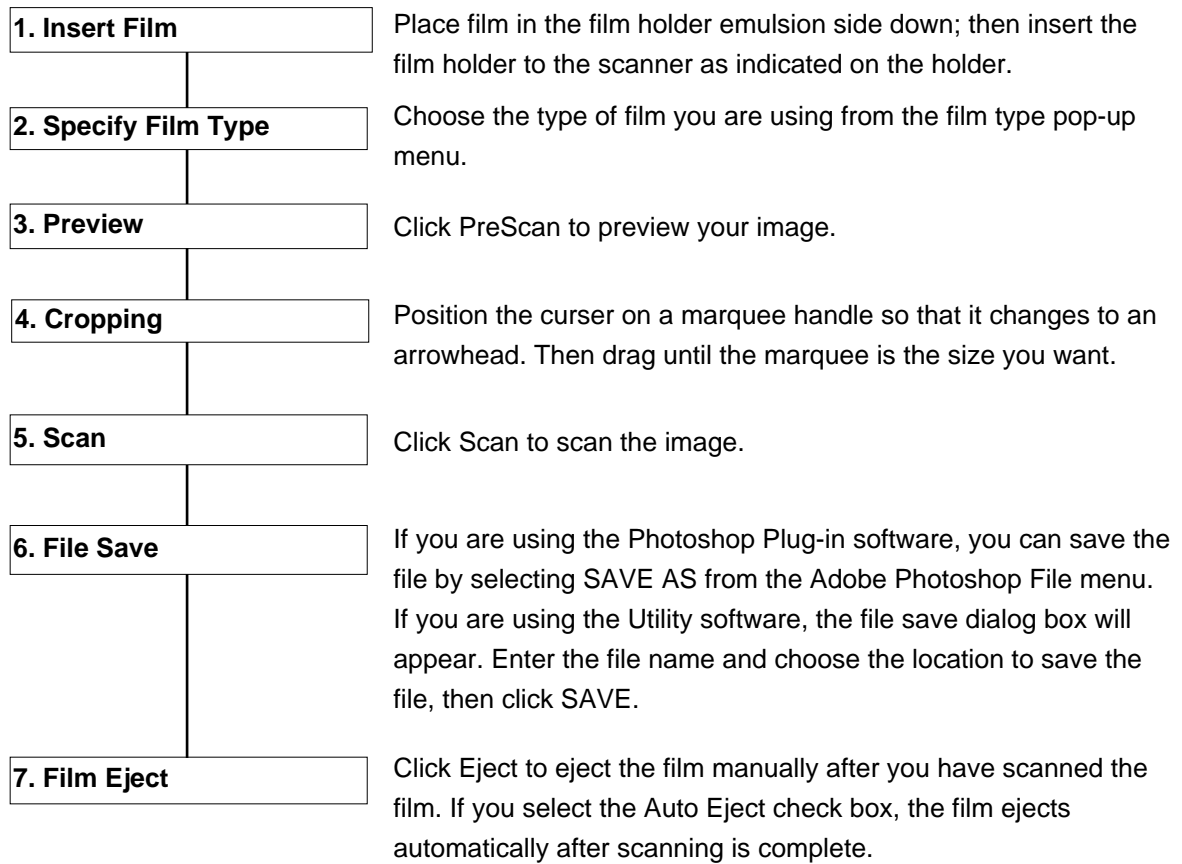

SCANNING IMAGES

1. START UP

Before you start Photoshop or the Utility software, turn on the QuickScan 35.

Start Adobe Photoshop. Then choose Acquire from the File menu and select QS35 Plug-in.

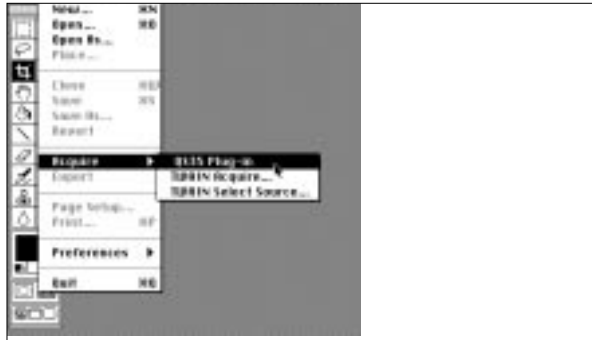

If you are using the Utility software, double click on the Utility icon. Select Scan from the File menu.

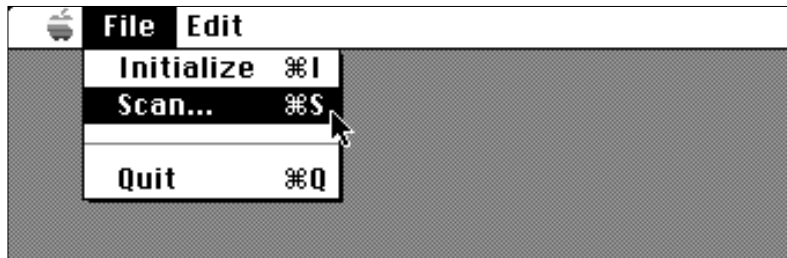

The setup dialog appears.

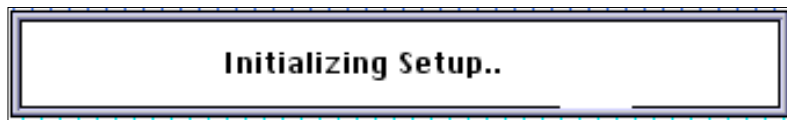

If you switch to the Utility software after using the Plug-in software, you have to setup again. Press command, shift, and I keys to restart the Plug-in software. Select Setup from the File menu to restart the Utility software.

QuickScan 35 dialog box and preview window appear, after setup.

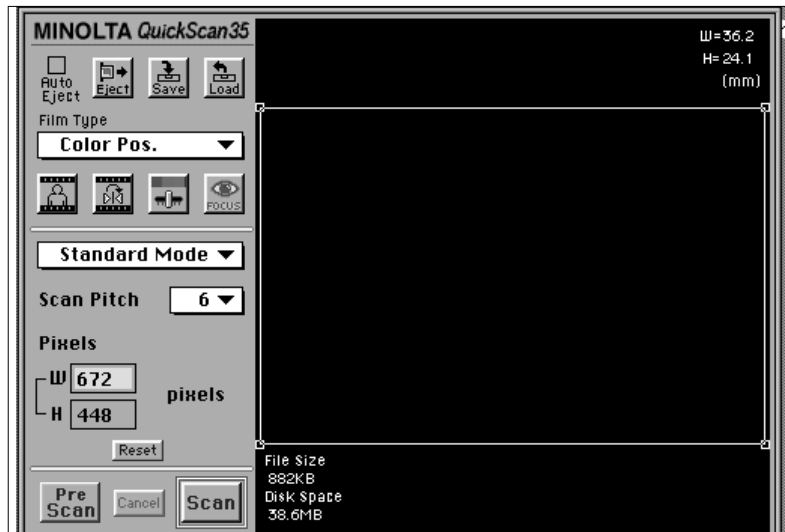

If the computer cannot confirm interface because the QuickScan 35 power is off or there is a problem with the SCSI connection or the SCSI ID number, a dialog box will appear. Correct the problem and click OK.

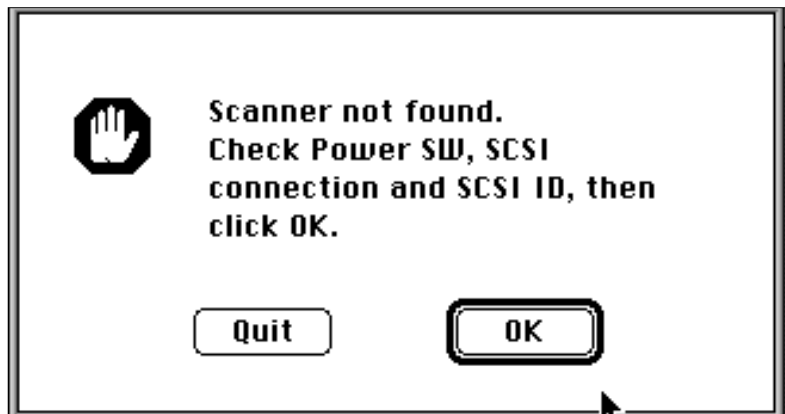

If the scanner detects that film is loaded or that there is abnormality in the scanner light source, a dialog box appears. Click Eject and remove the film.



2.INSERTING THE FILM

The QuickScan 35 can scan both color and monochrome (black & white), positive and negative 35mm film. Both film in slide mounts and film strips cut to a maximum of 6 frames can be scanned. The surface of the front and back of the film is different. The front is the base which has a glossy surface and the back is the emulsion which has a slight matte surface. Film must be inserted with the emulsion side facing right.

2.1. Film Strip

Film strip must be placed in the film holder before inserting it into the scanner. The film holder accepts film strips up to 6 frames long.

1. Open the film holder.
2. Place the film on the film holder with the emulsion side down.

Frames 1 through 3 should be placed right side up and frames 4 through 6 upside down so that the film fits in the holder.

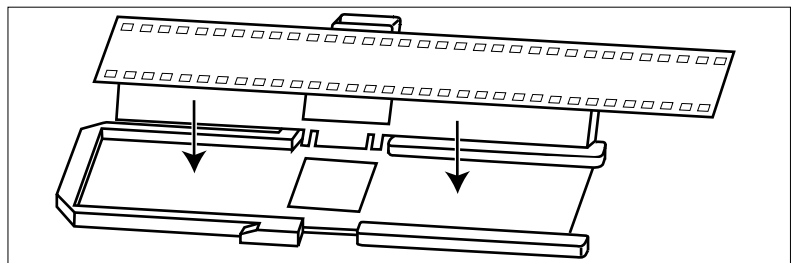
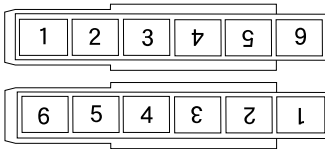

3. Align the frame you want to scan within the open area.
4. Snap the film holder closed.
5. Insert the film holder into the scanner film slot with the white lettering facing left.

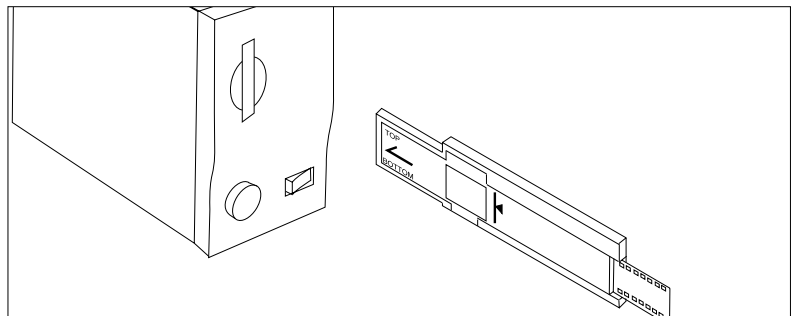

2.2. Slide Mount

The slide mount can be inserted as is.

Insert the slide mount, narrow end first, with the emulsion side facing right.

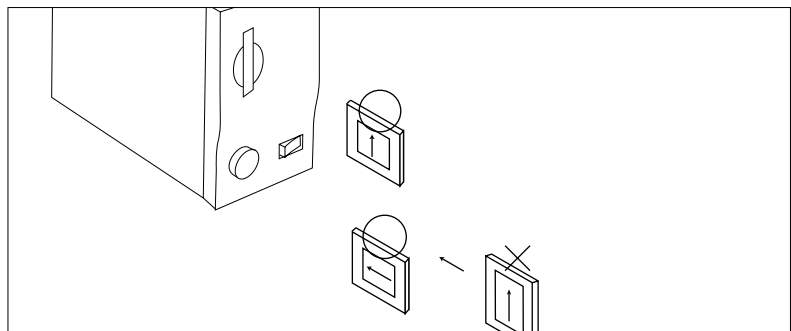

3. SPECIFYING THE FILM TYPE

Specifying the type of film you are scanning is necessary for an accurate reproduction of the image. There are four types of film to choose from: color negative, color positive, monochrome (black & white) negative, and monochrome (black & white) positive.

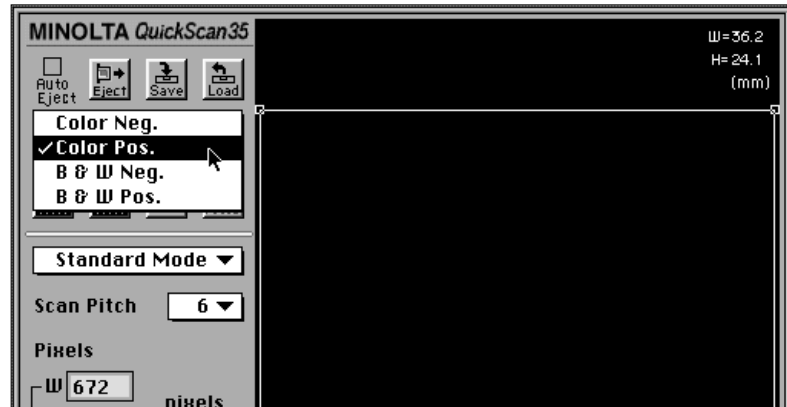

4. PREVIEWING THE IMAGE

Click PreScan to preview the image.



5. SCAN SETTINGS

5.1. Image Orientation Button

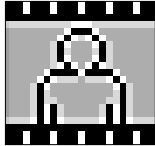

The image orientation button enables you to specify the correct orientation of your image before scanning. The image in a horizontal orientation is the default position. Click the image orientation button to rotate the picture 90° clockwise. The preview image will reflect this change. To change the rotation to counter-clockwise, press and hold the Option key while you click the image orientation button.

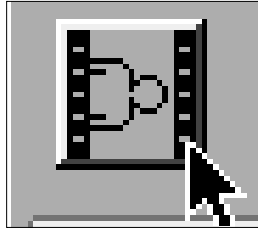

5.2. Flip Button

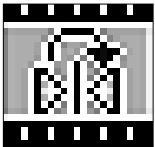

The flip button enables you to reverse the image before scanning. The default position is the image viewed from the film base side. Click the flip button to flip the image left-to-right horizontally. The preview image will reflect this change.

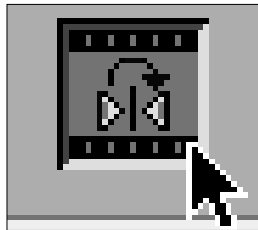

6. SELECTING THE SCAN MODE

The scan pitch is the number that determines how many pixels will form a single output signal. The lower the scan pitch, the higher the final image resolution, and the larger the file size.

You can select any of three scan modes: Standard, Pixel, or Print modes.

Standard Mode

This mode is the easiest and quickest to use because the print size and pixel number is automatically selected.

Pixel Mode

In this mode you can set the pixel size and scanning area. This enables you to match the image size to the size of the screen when the monitor is your final image medium.

Print Mode

Print mode is useful when you need to control the final image resolution to match your printer and to set the final image size.

6.1. Standard Mode

1. Choose Standard Mode from the scan mode pop-up menu.

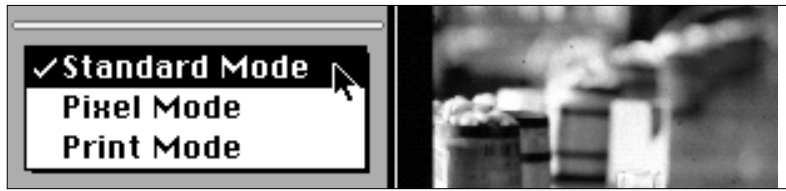

Scan Pitch Hint

Scan Pitch: 1

300 dpi printer produces an A4 size image

Scan Pitch: 2

300 dpi printer produces an A6 size image

Scan Pitch: 4

Image fits a 17 inch monitor

Scan Pitch: 6

Image fits a 13 inch monitor

2. Choose the scan pitch from the scan pitch pop-up menu.

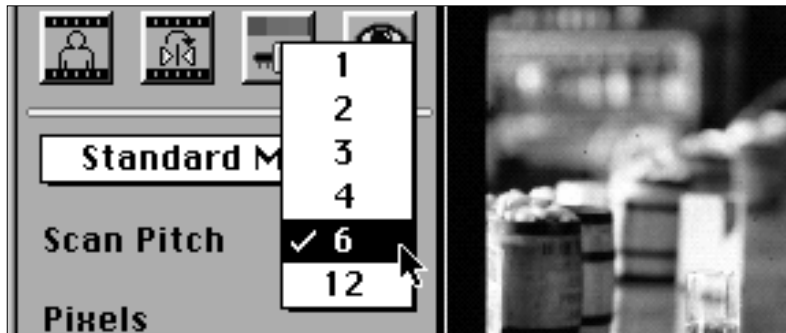

3. Crop the image as desired. The number of pixels will change accordingly to maintain the scan pitch.

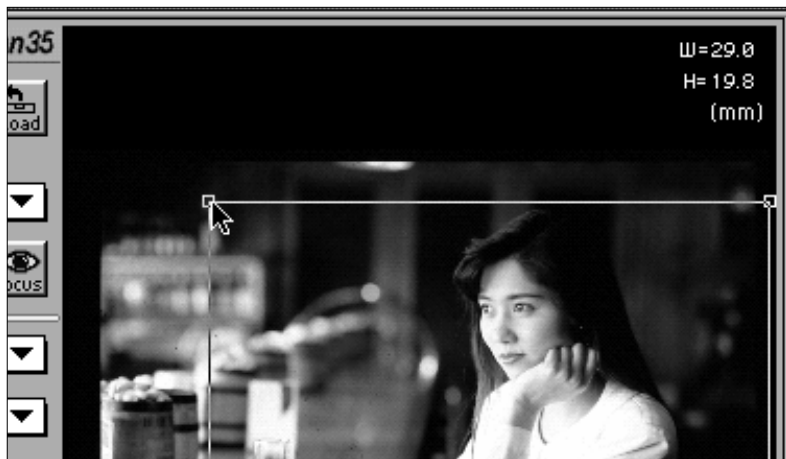

If you want to control the pixel number, you can directly input the number of pixels in the W (width) and H (height) boxes. The selection will change accordingly to maintain the scan pitch.

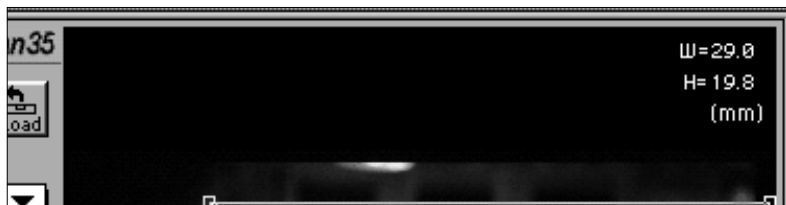

- Click RESET to return to the default settings.

6.2. Pixel Mode

1. Choose Pixel Mode from the scan mode pop-up menu.

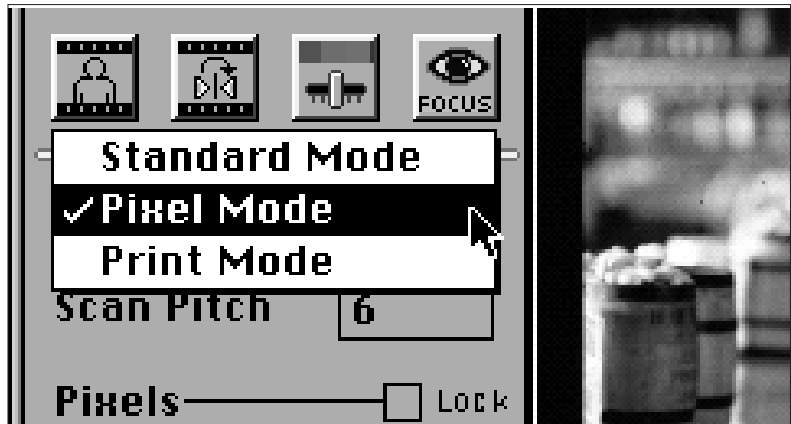

2. Enter the number of pixels in the W (width) and H (height) boxes, then select the Lock check box.

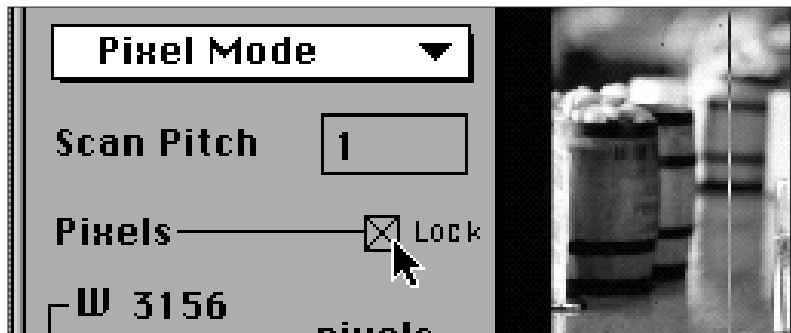

3. Crop the image as desired. The scan pitch changes automatically from 1 to 24 to maintain the pixel number.
• Click RESET to return to the default setting.

6.3. Print Mode

1. Choose Print Mode from the scan mode pop-up menu.
2. Enter the resolution you want for the final image in the output resolution box.



3. Select the units of measure for the final image size using the units pop-up menu. You can select centimeters, inches, picas, or points.

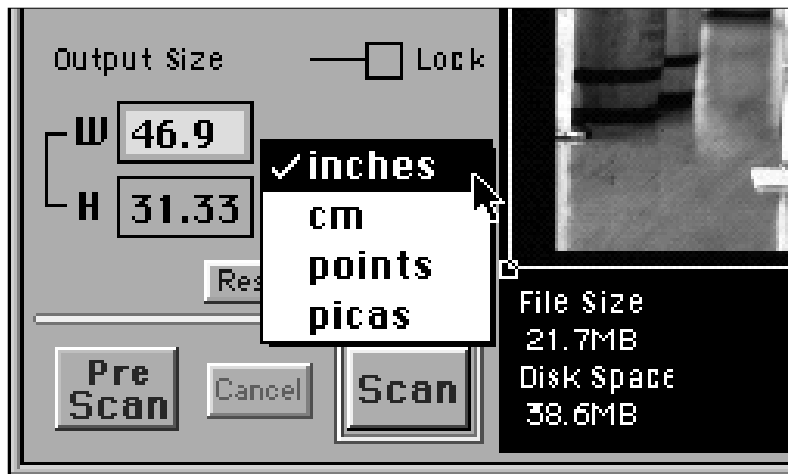

4. Roughly crop the image.
5. Enter the output image dimensions in the W (width) and H (height) boxes and select the Lock check box.

The output resolution set in Print Mode is valid for Standard Mode and Pixel Mode.

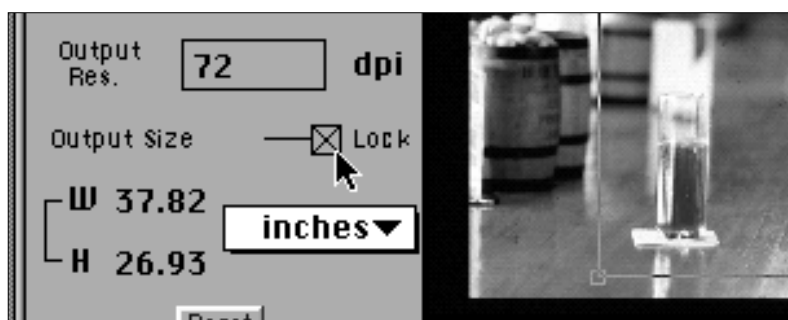

- Click RESET to return to the default settings.

7. SCANNING THE IMAGE

When you have finished making all the adjustments to the image, you are ready to scan the film. Click Scan. The control panel



disappears and scanning begins.

- If you are using the Photoshop Plug-in software, the image will appear in a Photoshop window when the scan is complete. If you are using the Utility software, the save dialog box will appear so you can save the image data.

8. SAVING THE FILE

If you are using the Photoshop Plug-in software, select SAVE AS from the File menu. The Save As dialog box will appear. Enter the file name and the location to save the file, then click Save.

If you are using the Utility software, the save dialog box will appear after the image is scanned. Enter the file name and choose the location to save the file, then click Save.

9. EJECTING THE FILM

When scanning negative film, do not remove the film holder from the scanner until it has been properly ejected.

Removing the film, changing the frame, and inserting the film again without ejecting the film first will cause image distortions.

The film can be ejected manually or automatically. You should eject the film after you have finished scanning and before you turn off the scanner. Click Eject to eject the film manually. If you select the Auto Eject check box, the film ejects automatically after the scanning is complete.



IMAGE ADJUSTMENT

You can adjust the color balance, brightness, and black level of the image. Click the image adjustment button to display the controls.

1. COLOR BALANCE ADJUSTMENT

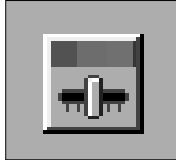

The primary colors used in scanners, as well as photography, are red, green, and blue. The QuickScan 35's red, green, and blue controls enable you to adjust the color of image before scanning. Drag the slider to the right if you want to make the color more prominent in the image or to the left to reduce the level of that color. Clicking one of the arrows moves the slider one step.

- The preview image reflects the adjustments.
- The values next to the controls show the amount of the color change. The color values range from -20 to +20.

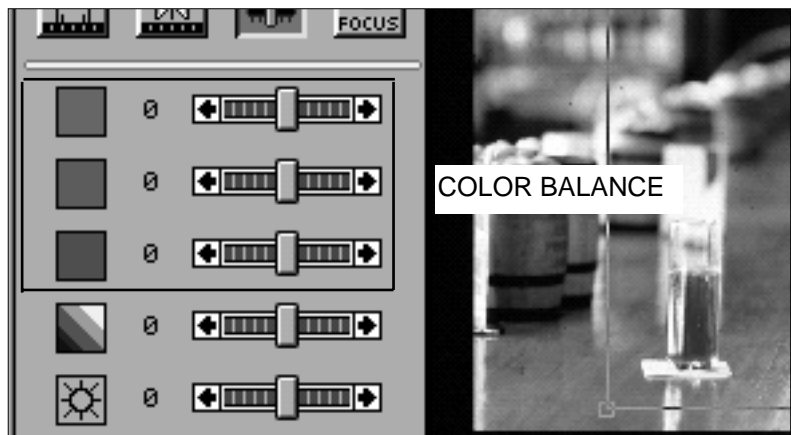

2. BLACK LEVEL ADJUSTMENT

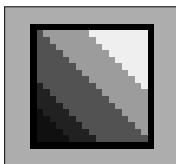

This control allows you to adjust the overall black level of the image. Drag the slider to the right to lighten the black tones in the image or to the left to darken the black tones. Clicking one of the arrows moves the slider one step.

- The preview image reflects the adjustments.
- The values next to the controls show the amount of the change brightness. The black level values range from -20 to +20.

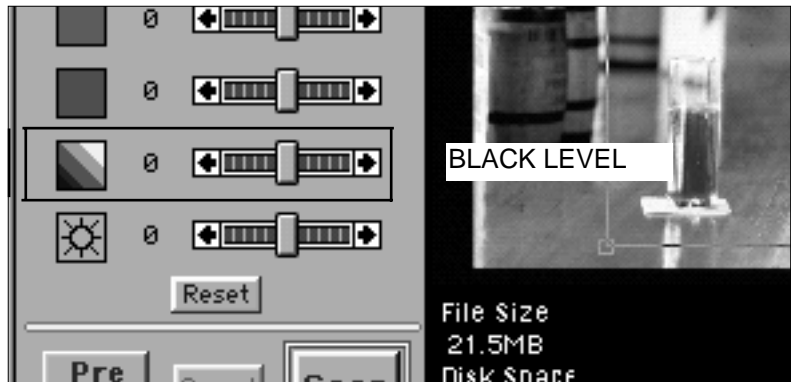

3. BRIGHTNESS ADJUSTMENT

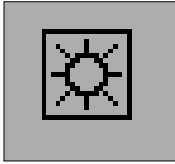

This control allows you to adjust the overall brightness of the image. Drag the slider to the right to increase brightness and to the left to decrease brightness. Clicking one of the arrows moves the slider one step.

- The preview image reflects the adjustments.
- The values next to the controls show the amount of the change brightness. The brightness values range from -20 to +20.

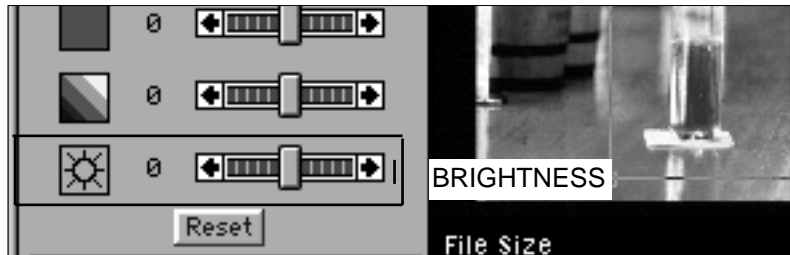

4. RESET

Click the Reset button to return the image adjustment controls to their default settings.



5. RGB/CMY LEVEL CHECKER

The color level at a cursor's position on the preview image is displayed in the lower right corner of the preview window and the size of the selection area on the film is displayed in the upper right corner.

To determine the color level at a very precise point, position the cursor outside the selection area so that it changes to the cross cursor. Then position it over the area you want to measure. The digital value of the RGB level is displayed.

- To display the CMY level, hold down the CONTROL key while you move the mouse.



MANUAL FOCUS

Normally, focusing is not necessary with the QuickScan 35, however, it is recommended when your final image will be large and if the film strip is curled or a paper slide mount is warped.

1. Click the focus button. The cursor changes to the focus icon.



2. Position the focus icon over the area you want to focus and click the mouse button. The focus indicator window appears.

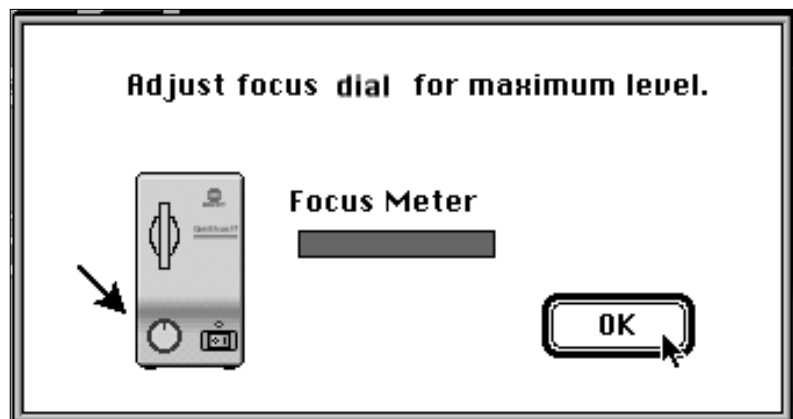

3. Turn the focus dial on the front of the QuickScan 35 until the black box and the red bar are their longest.
4. Click OK when you have finished focusing.

SAVE AND LOAD BUTTONS

The Save and Load buttons enable you to save and load several different scanner settings. These saved settings are very useful when you are scanning a series of images that were taken under similar photographic conditions.

1. SAVE

Click SAVE. A dialog box will appear. Enter the file name and choose a location to save the file; then click Save.

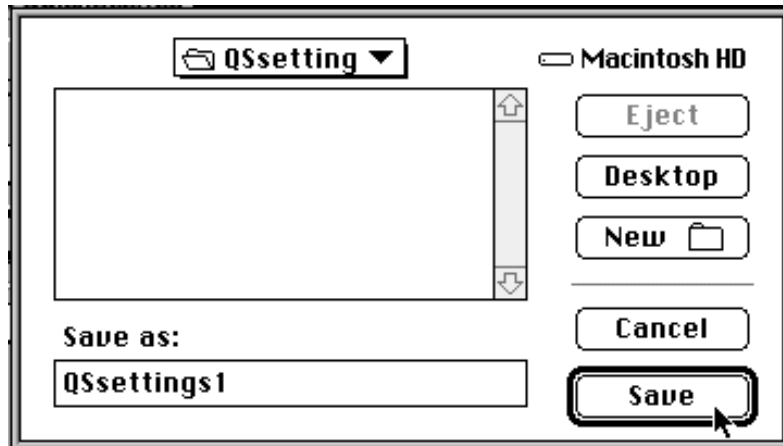

2. LOAD

Click LOAD. A dialog box will appear. Select the settings file you want to use and click Open.

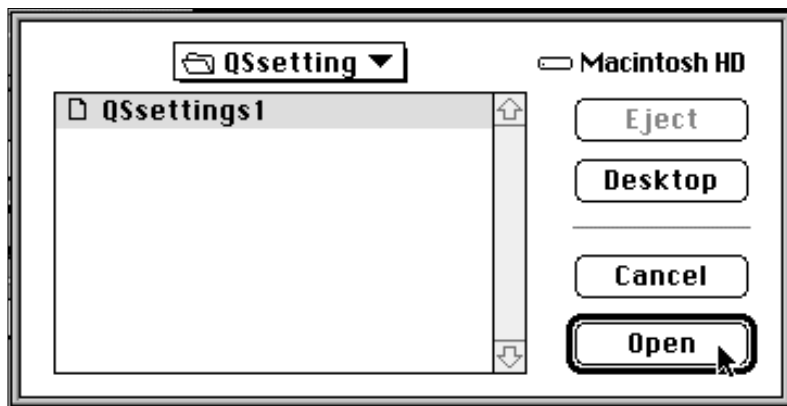

FLUORESCENT LAMP AUTOMATIC SHUT OFF

The setting-up takes approximately 30 - 60 seconds before the fluorescent lamp glows again.

The fluorescent light source automatically turns off if the Macintosh has not been operated for two hours.

- The lamp will come on again the next time you use QuickScan35.

COLOR SYNC

Color Sync compensates for the different color characteristics of each instrument (i.e., monitor or printer) connected to the Macintosh.

1. INSTALLATION

1. If you have never used Color Sync, insert the QuickScan 35 disk to the Macintosh.
2. Double click on the disk icon.
3. Drag both the Color Sync and Color Sync System Profile icons to the main System folder.

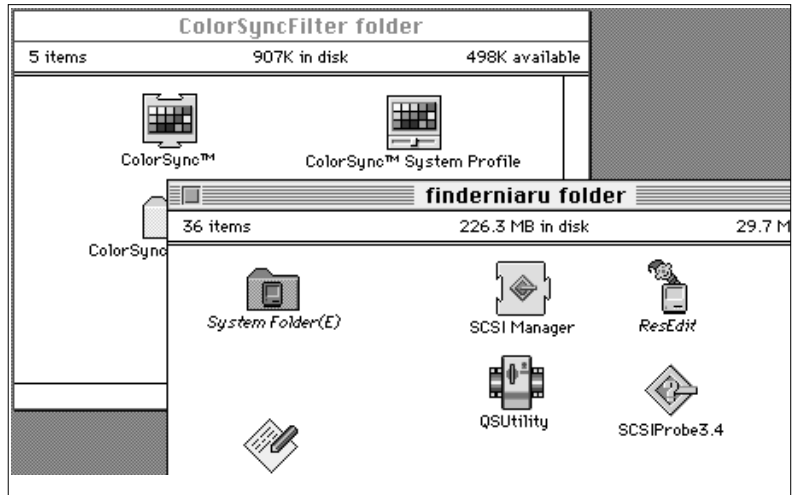

4. Drag the Color Sync System Profiles folder to the preferencesSettings folder in the System folder.

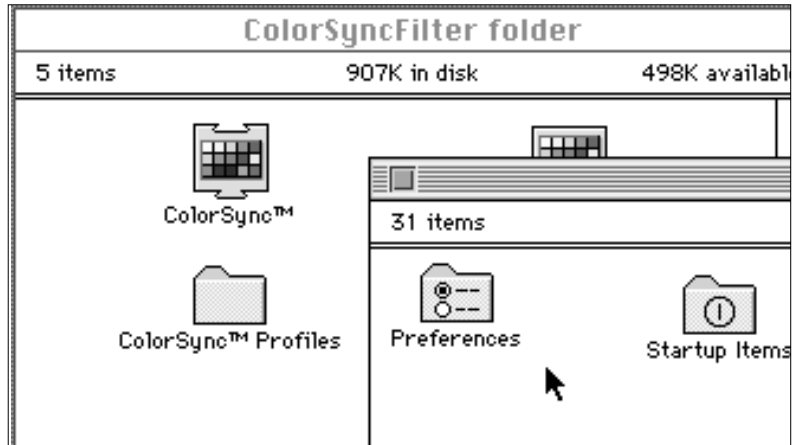

5. Drag the Color Sync Filter folder to the Photoshop Plug-ins folder.

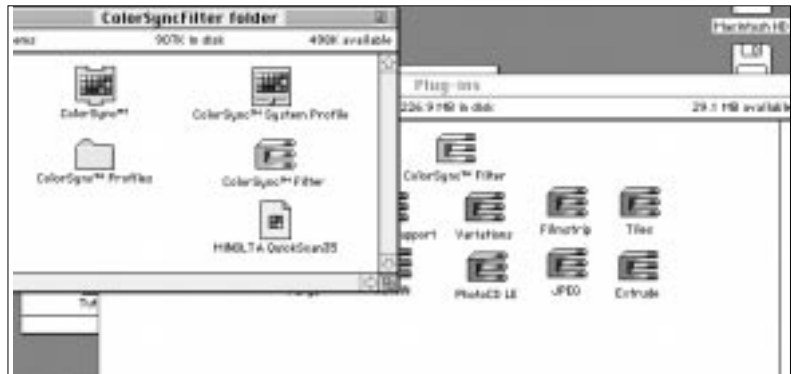

- 1.If you have already used Color Sync, drag the QuickScan 35 file to the Color Sync Profiles folder in the Initial Settings folder.
- 2.Drag the Color Sync Filter icon to the Plug-in folder in Photoshop.

2. OPERATION

1. When the scanned image appears in the Photoshop window, choose Color Sync from Others in the Filter menu.

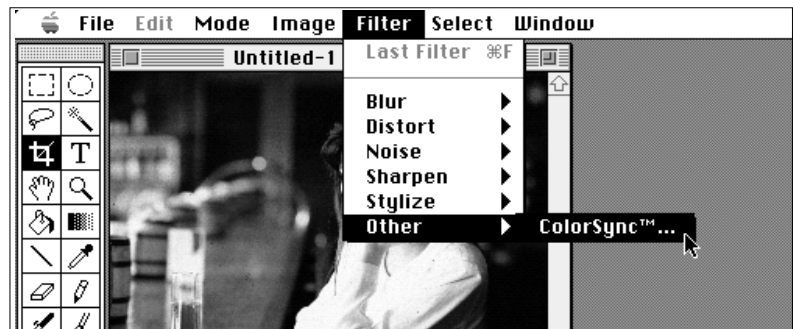

2. The Color Sync dialog box appears with the following information:

Source Profile: MINOLTA QuickScan 35

Destination Profile: Monitor in use

Matching Option: Photographic

TROUBLE SHOOTING

Q:The Macintosh does not start up after connecting the QuickScan 35.

A:Turn power off, then check SCSI cable, SCSI connection, and SCSI ID number.

Q:QS35 Plug-in does not appear in the plug-in menu.

A:Check the plug-in folder selection in the "Plug-in..." menu in the Optional Settings of Photoshop.

Q:Operation stops during plug-in setup, preview, or scan.

A:Check System Requirements on page XX.

A:Turn power off, then check SCSI cable, SCSI connection, and SCSI ID number.

Q:Scan speed is extremely slow with Plug-in software.

A:Increase Photoshop memory.

Q:"Insufficient Memory" message appears.

A:If you are using the Utility software, increase memory.

A:If you are using the Photoshop Plug-in software, increase Photoshop memory.

A:If the message appears several times during the use of Photoshop, restart Photoshop.

Q:Grain is visible when scanning high-speed film.

A:Slightly defocus the image using manual focus.

Q:Color is unusual when scanning color negative film, especially images taken under fluorescent lighting.

A:Scan again or correct the color using the color adjustment function.

Q:"Change the fluorescent lamp" message appears.

A:Change the fluorescent lamp. Contact a Minolta Service facility.

Q:Film is not inserted, but "Film loaded or Scanner Error detected. . . ." message appears.

A:Change the fluorescent lamp. Contact a Minolta Service facility.

SPECIFICATIONS

Type:Film transport type

Usable Film:35mm negative/positive, color/monochrome (black & white) films

Scanning Dimensions:24.2mm x 36.3mm; Maximum 2820 dpi (2688 x 4032 pixels)

Pixel Density:110 pixels/mm, 2828 dpi (on film)

Interface:SCSI2

Scanning Time:Scanning:approx. 12 sec. (1000 x 1000 pixels)
approx. 60 sec. (2688 x 4032 pixels)

Preview:approx. 6 sec. (positive)

Image Sensor:RGB 3-line color CCD

Light Source:Fluorescent lamp

Color Separation Sequence:1 pass

Focus:Focus detection: High-frequency detection type

Focus adjustment: Manual

Dimensions:100(W) x 169(H) x 300(D)mm

Weight:3.3kg

Power Consumption:Less than 30W

Operating Temperature and Humidity:Temperature: 10 to 35°C;

Humidity: 20 to 80%





QuickScan 35

High Resolution & Fine Gradation

INSTRUCTION MANUAL

