



KONICA MINOLTA

DiMAGE X50



E INSTRUCTION MANUAL

BEFORE YOU BEGIN

Thank you for purchasing this product. Please take the time to read through this instruction manual so you can enjoy all the features of your new digital camera.

Check the packing list before using this product. If any items are missing, immediately contact your camera dealer.

- DiMAGE X50 digital camera
- Lithium-ion battery NP-700
- Lithium-ion battery charger BC-800
- Hand strap HS-DG130
- SD Memory Card
- USB cable USB-3
- AV cable AVC-500
- DiMAGE Viewer CD-ROM
- „DiMAGE Instruction Manuals“-CD-ROM
- Quick Reference Guide
- International Warranty Certificate

Only use the battery specified in this manual that are manufactured and distributed by Konica Minolta. Beware of counterfeit batteries; the use of these batteries will damage the product and may cause fire.

While reasonable efforts have been made to assure the accuracy of this information, Konica Minolta assumes no liability or responsibility for any errors or omissions of this instruction manual.

Konica Minolta is a trademark of Konica Minolta Holdings, Inc. DiMAGE is a trademark of Konica Minolta Photo Imaging, Inc. Apple, the Apple logo, Macintosh, Power Macintosh, Mac OS, and the Mac OS logo are registered trademarks of Apple Computer Inc. Microsoft and Windows are registered trademarks of the Microsoft Corporation. The official name of Windows is Microsoft Windows Operating System. Pentium is a registered trademark of the Intel Corporation. Power PC is a trademark of the International Business Machines Corporation. QuickTime is a trademark used under license. All other brand and product names are trademarks or registered trademarks of their respective owners.

FOR PROPER AND SAFE USE

Lithium-ion batteries

This camera operates on a small, but powerful lithium-ion battery. Misuse or abuse of the lithium-ion battery can cause damage or injury through fire, electric shock, or chemical leakage. Read and understand all warnings before using the battery.

DANGER

- Do not short, disassemble, damage, or modify the battery.
- Do not expose the battery to fire or high temperatures over 60°C (140°F).
- Do not expose the battery to water, or moisture. Water can corrode or damage the internal battery safety devices and cause the battery to overheat, ignite, rupture, or leak.
- Do not drop or subject the battery to strong impacts. Impacts can damage the internal battery safety devices and cause the battery to overheat, ignite, rupture, or leak.
- Do not store the battery near or in metallic products.
- Do not use the battery with any other products.
- Only use the specified charger. An inappropriate charger may cause damage or injury through fire or electric shock.
- Do not use a leaking battery. If fluid from the battery enters your eye, immediately rinse the eye with plenty of fresh water and contact a doctor. If fluid from the battery makes contact with your skin or clothing, wash the area thoroughly with water.
- Only use or charge the battery in an environment with ambient temperatures between 0° and 40°C (32° and 104°F). Only store the battery in an environment with ambient temperatures between -20° and 30°C (-4° and 86°F) and a humidity of 45% to 85% RH.

WARNING

- Tape over the lithium-ion battery contacts to avoid short-circuiting during disposal; always follow local regulations for battery disposal.
- If charging is not completed after the specified period elapses, unplug the charger and discontinue charging immediately.

GENERAL WARNINGS AND CAUTIONS

Read and understand the following warnings and cautions for safe use of the digital camera and its accessories.

WARNING

- Only use the battery specified in this manual.
- Only use the specified charger or AC adapter within the voltage range indicated on the unit. An inappropriate adapter or current may cause damage or injury through fire or electric shock.
- Only use the charger power cord in the sales region for which it was designed. An inappropriate current may cause damage or injury through fire or electric shock.
- Do not disassemble the camera or charger. Electric shock may cause injury if a high voltage circuit inside the product is touched.
- Immediately remove the battery or unplug the AC adapter and discontinue use if the camera is dropped or subjected to an impact in which the interior, especially the flash unit, is exposed. The flash has a high voltage circuit which may cause an electric shock resulting in injury. The continued use of a damaged product or part may cause injuries or fire.
- Keep the battery, memory card, or small parts that could be swallowed away from infants. Contact a doctor immediately if an object is swallowed.
- Store this product out of reach of children. Be careful when around children not to harm them with the product or parts.
- Do not fire the flash directly into the eyes. It may damage eyesight.
- Do not fire the flash at vehicle operators. It may cause a distraction or temporary blindness which may lead to an accident.
- Do not use the monitor while operating a vehicle or walking. It may result in injury or an accident.
- Do not look directly at the sun or strong light sources through the viewfinder. It may damage your eyesight or cause blindness.
- Do not use these products in a humid environment, or operate them with wet hands. If liquid enters these products, immediately remove the battery or unplug the product, and discontinue use. The continued use of a product exposed to liquids may cause damage or injury through fire or electric shock.
- Do not use these products near inflammable gases or liquids such as gasoline, benzine, or paint thinner. Do not use inflammable products such as alcohol, benzine, or paint thinner to clean these products. The use of inflammable cleaners and solvents may cause an explosion or fire.
- When unplugging the AC adapter or charger, do not pull on the power cord. Hold the plug when

removing it from an outlet.

- Do not damage, twist, modify, heat, or place heavy objects on the AC adapter or charger cord. A damaged cord may cause damage or injury through fire or electric shock.
- If these products emits a strange odor, heat, or smoke, discontinue use. Immediately remove the battery taking care not to burn yourself as the battery may become hot with use. The continued use of a damaged product or part may cause injuries or fire.
- Take the product to a Konica Minolta service facility when repairs are required.
- Handling the cord on this product may expose you to lead, a chemical known to the State of California to cause cancer, and birth defects or other reproductive harm. Wash hands after handling.
- The subject must not be closer than 1 m when photographing portraits with flash in order to avoid damage to the eyes.

CAUTION

- Do not use or store these products in a hot or humid environment such as the glove compartment or trunk of a car. It may damage the camera, charger, and battery which may result in burns or injuries caused by heat, fire, explosion, or leaking battery fluid.
- If the battery is leaking, discontinue use of the product.
- The camera, charger, and battery temperature rises with extended periods of use. Care should be taken to avoid burns.
- Burns may result if the memory card or battery is removed immediately after extended periods of use. Turn the camera off and wait for it to cool.
- Do not fire the flash while it is in contact with people or objects. The flash unit discharges a large amount of energy which may cause burns.
- Do not apply pressure to the LCD monitor. A damaged monitor may cause injury, and the liquid from the monitor may cause inflammation. If liquid from the monitor makes contact with skin, wash the area with fresh water. If liquid from the monitor comes in contact with the eyes, immediately rinse the eyes with plenty of water and contact a doctor.
- When using the AC adapter and charger, insert the plug securely into the electrical outlet.
- Do not use electronic transformers or travel adapters with the charger. The use of these devices may cause a fire or damage the product.
- Do not use if the AC adapter or charger cord is damaged.
- Do not cover the AC adapter or charger. A fire may result.
- Do not obstruct access to the AC adapter or charger; this can hinder the unplugging of the units in emergencies.
- Unplug the AC adapter or charger when cleaning or not in use.

The following marks may be found on the product:



This mark on your camera certifies that this camera meets the requirements of the EU (European Union) concerning interference causing equipment regulations. CE stands for Conformité Européenne (European Conformity).

This Class B digital apparatus complies with Canadian ICES-003.

FCC Compliance Statement
Declaration on Conformity

Responsible Party: Konica Minolta Photo Imaging USA Inc.
Address: 725 Darlington Avenue, Mahwah, NJ 07430

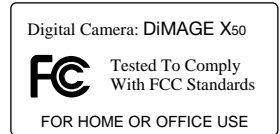

This device complies with Part 15 of the FCC Rules. Operation is subject to the following two conditions: (1) This device may not cause harmful interference, and (2) this device must accept any interference received, including interference that may cause undesired operation. Changes or modifications not approved by the party responsible for compliance could void the user's authority to operate the equipment.

This equipment has been tested and found to comply with the limits for a Class B digital device, pursuant to Part 15 of the FCC Rules. These limits are designed to provide reasonable protection against harmful interference in a residential installation. This equipment generates, uses and can radiate radio frequency energy and, if not installed and used in accordance with the instructions, may cause harmful interference to radio communications. However, there is no guarantee that interference will not occur in a particular installation. If this equipment does cause harmful interference to radio or television reception, which can be determined by turning the equipment off and on, the user is encouraged to try to correct the interference by one or more of the following measures:

- Reorient or relocate the receiving antenna.
- Increase the separation between the equipment and the receiver.
- Connect the equipment to an outlet on a circuit different from that to which the receiver is connected.
- Consult the dealer or an experienced radio/TV technician for help.

Do not remove the ferrite cores from the cables.

TABLE OF CONTENTS

The getting up and running section covers how to prepare the camera for use. It contains important information about power supplies and memory cards. The basic operation of this camera is covered in the recording - basic operation section between pages 21 and 31, and the playback - basic operation section between pages 32 and 35. Read the data-transfer mode section in its entirety before connecting the camera to a computer.

Many of the features of this camera are controlled with menus. The menu navigation sections concisely describe how to change menu settings. Descriptions of the settings immediately follow the navigation sections.

The appendix contains a troubleshooting section to help answer questions about the operation of the camera. Information covering camera care and storage is also provided. Please store this manual in a safe place.

Names of parts	12
Getting up and running	14
Charging the battery.....	14
Inserting the battery	15
Battery-condition indicator.....	16
Auto power save	16
AC adapter (sold separately).....	17
Attaching the strap.....	17
Installing and removing a memory card.....	18
About memory cards.....	19
Setting the date and time.....	20

Recording mode - basic operation	21
Handling the camera	21
Setting the camera to record images.....	21
LCD monitor display.....	22
Camera-shake warning	22
Using the zoom lens.....	23
Basic recording operation	24
Automatic Digital Subject Program Selection.....	25
Focus lock	26
Focus range.....	26
Focus signals	27
Special focusing situations	27
Flash modes.....	28
Flash range - Automatic operation	29
Flash signals.....	29
Display button - recording mode	29
Digital subject programs	30
Spot AF	31
Playback - basic operation	32
Single-frame playback display	32
Rotating images	33
Deleting single images	33
Display button - playback mode	34
Enlarged playback.....	35
Recording - advanced operation	36
Movie recording.....	36
Drive modes	37
Multi frame.....	37
Self-timer	38
Continuous advance & UHS continuous advance	39
Navigating the recording menus	40
Image size and image quality.....	42
Color mode.....	43
White balance.....	44
Custom key function	45
Auto reset	45
Camera sensitivity - ISO	46
Flash range and camera sensitivity.....	46
Metering modes	47
Instant playback.....	47
Exposure compensation.....	48
Voice memo.....	49
Date imprinting	50
Digital zoom.....	51
Recording mode.....	52
Audio recording	52
Frame rate & movie file sizes	53
Movie mode.....	53

Playback - advanced operation.....	54
Playing back voice memos and audio captions	54
Playing back movies and audio recordings	55
Navigating the playback menu.....	56
Deleting image and audio files.....	58
Audio caption	59
Locking files	60
Image pasting.....	60
Slide show	62
Dissolve	62
Crop frame	63
E-mail copy	64
Frame capture	65
Movie editing.....	66
About DPOF	68
DPOF setup.....	68
Date print.....	69
Index print	69
Setup mode	70
Navigating the setup menu	70
LCD monitor brightness	72
Formatting memory cards.....	72
File number (#) memory	73
Folder Name.....	73
Language.....	74
Audio signals	74
Focus signal	74
Shutter FX.....	75
Volume.....	75
Auto power save	75
Reset default	76
Date and time	77
Transfer mode	77
Video output.....	78
Viewing images on a television	78

Data-transfer mode.....	79
System requirements	79
Connecting the camera to a computer.....	80
Connecting to Windows 98 and 98SE.....	81
Automatic installation	81
Manual installation.....	82
Memory card folder organization	84
Auto power save - data transfer mode.....	85
Disconnecting the camera from the computer	86
Windows 98 / 98 Second Edition.....	86
Windows XP, 2000 Professional, and Me.....	86
Macintosh	87
Changing the memory card - data-transfer mode.....	88
QuickTime system requirements.....	88
Removing the driver software - Windows.....	89
PictBridge.....	90
Notes on printing errors	91
Navigating the PictBridge menu	92
Remote camera system requirements	96
Installing the remote camera driver.....	96
Connecting the remote camera	98
Notes on remote camera operation	99
Appendix	100
Troubleshooting	100
About the lithium-ion battery charger cord.....	101
Care and storage.....	102
Camera care	102
Cleaning.....	102
Storage	102
Memory cards.....	103
Batteries.....	103
Before important events and journeys	103
Operating temperatures and conditions.....	104
LCD monitor care	104
Copyright	104
Questions and service	104
What is an Ev?	105
Technical specifications	106

NAMES OF PARTS

* This camera is a sophisticated optical instrument. Care should be taken to keep these surfaces clean. Please read the care and storage instructions in the back of this manual (p. 102).

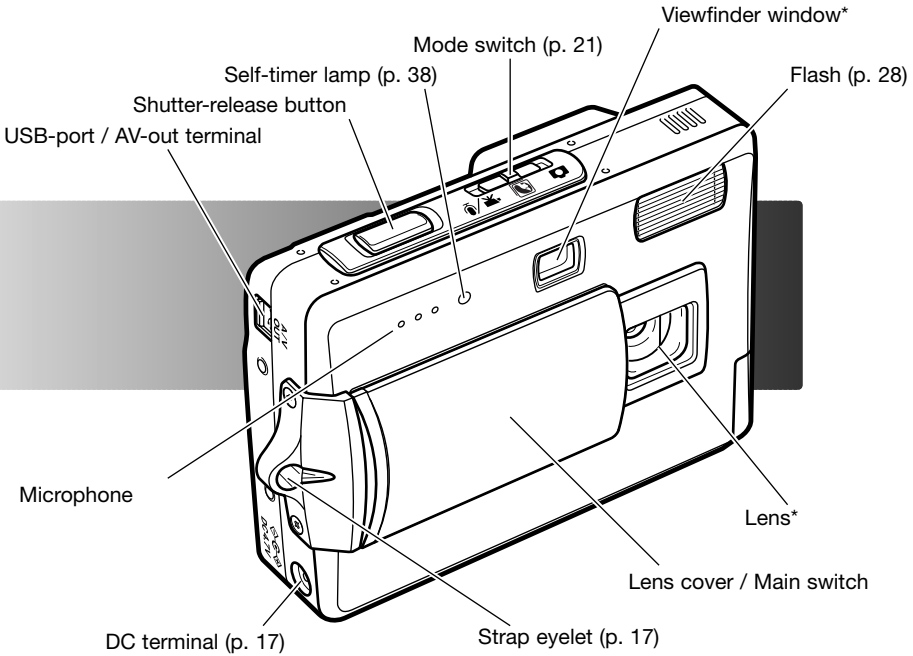

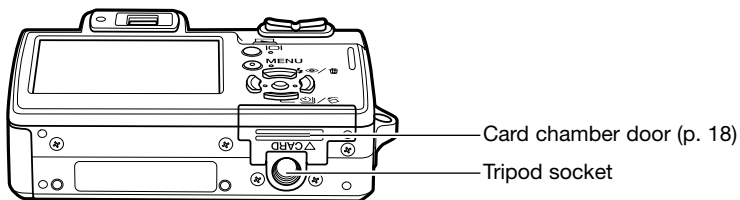
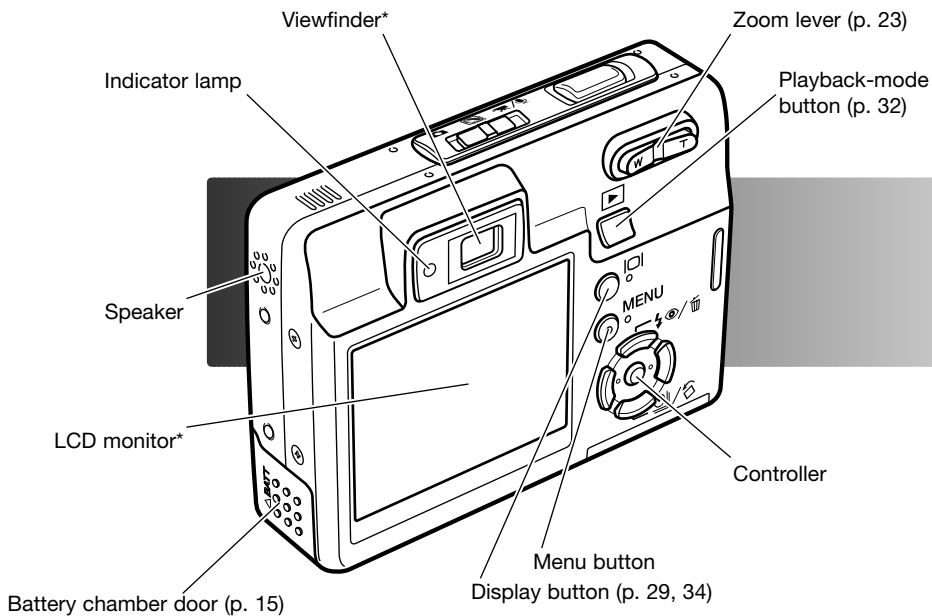

GETTING UP AND RUNNING

CHARGING THE BATTERY

Before the camera can be used, the lithium-ion battery must be charged. Before charging the battery, read the safety warnings on pages 3 and 4 of this manual. Only recharge the battery with the supplied battery charger. The battery should be recharged before each shooting session. See page 103 for battery care and storage.

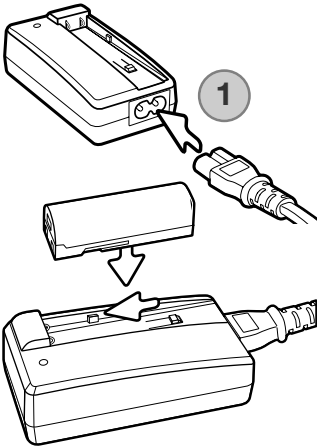

Plug the power cord into the back of the charger unit (1). Plug the other end of the cord into a live household outlet. The included AC cord is designed for the current of the sales region. Only use the cord in the region it was purchased. For more on the AC cable, see page 101.

With the battery terminals forward lower the battery into the charger so the guides in the charger bed enter the channels on the battery. Slide the battery forward into the charger.

The indicator lamp (2) glows to show the battery is charging. The lamp goes out when the battery has been charged. Charging time is approximately 90 minutes. Remove the battery from the charger. Unplug the power cord from the outlet.

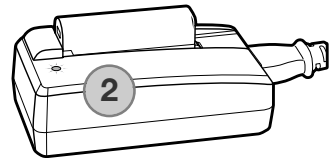

INSERTING THE BATTERY

This digital camera uses one NP-700 lithium-ion battery. Before using the battery, read the safety warnings on pages 3 and 4 of this manual. When replacing the battery, the camera should be turned off (p.19).

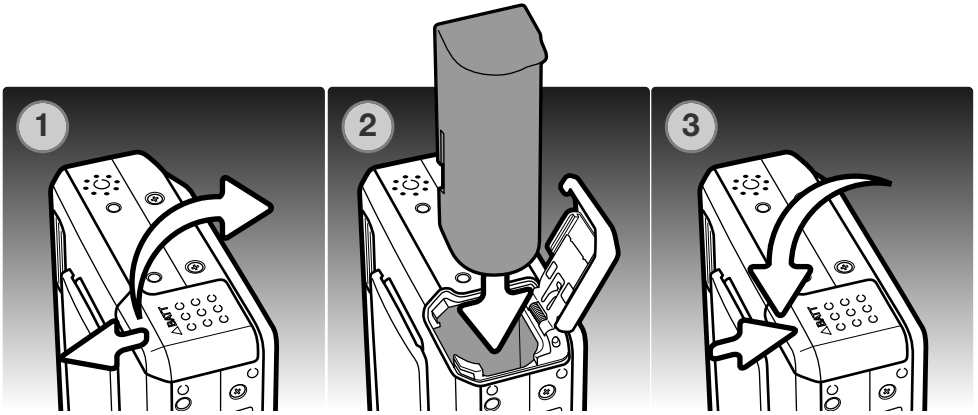

1. Slide the battery-chamber door toward the front of the camera to release the safety catch. Open the door.
2. Slide the battery into the battery chamber with the battery terminals first.
3. Close the battery-chamber door and slide it toward the back of the camera to engage the safety catch.

After installing the battery, the set-time/date message may appear on the monitor, see page 20 on how to set up the clock. An internal battery protects the clock, calendar, and memory settings for more than 24 hours if the camera is used for at least 5 minutes before removing the battery.

BATTERY-CONDITION INDICATOR

This camera is equipped with an automatic battery-condition indicator displayed on the LCD monitor. The icon will change from white to red when battery power is low.



Full-battery indicator - the battery is fully charged. This indicator is displayed when the camera is on.



Low-battery indicator - the battery is partially charged.



Low-battery warning - battery power is very low. The battery should be replaced as soon as possible. This warning automatically appears and remains on the monitor until the battery is recharged. Movie recording is not possible. If the power level falls below this level when the camera is on, the battery-exhausted message appears just before the camera shuts down.

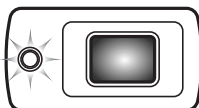

If power is insufficient for camera operation, the indicator lamp next to the viewfinder will turn orange and blink for three seconds. The shutter will not release. The battery must be recharged.

AUTO POWER SAVE

To conserve battery power, the camera shuts down if an operation is not made within three minutes. To restore power, press the shutter-release button or playback button. The length of the auto-power-save period can be changed in section 2 of the setup menu (p. 70). When the camera is connected to a computer or PictBridge printer, the auto-power-save period is set to ten minutes and cannot be changed.

AC ADAPTER (SOLD SEPARATELY)



Always turn off the camera before changing between power supplies.

1

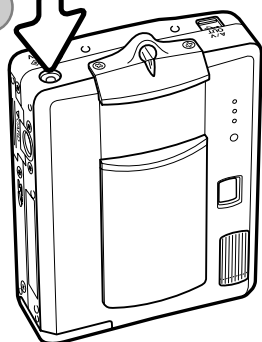

The AC adapter AC-4 or AC-5 allows the camera to be powered from a household outlet. The AC adapter is recommended when the camera is interfaced with a computer or during periods of heavy use. AC adapter model AC-4 is for use in North America, Japan, and Taiwan, and AC-5 is for use in all other areas. The battery cannot be charged using the AC adapter.

1. Insert the mini-plug of the AC adapter into the DC terminal.
2. Insert the AC adapter plug into an electrical outlet.

ATTACHING THE STRAP

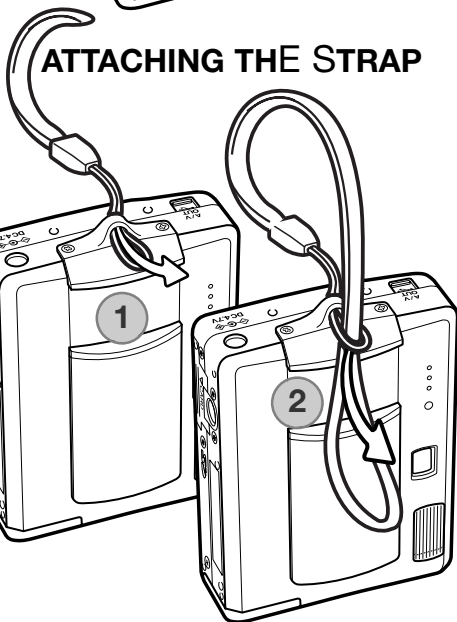

Always keep the strap around your wrist in the event that the camera is accidentally dropped.

1. Pass the small loop of the strap through the strap eyelet on the camera body.
2. Pass the other end of the strap through the small loop and tighten.

INSTALLING AND REMOVING A MEMORY CARD



Always turn off the camera and confirm the indicator lamp is not lit before changing the memory card, otherwise the card may be damaged, and data lost.

An SD (Secure Digital) Memory card or MultiMediaCard must be inserted for the camera to operate. If a card has not been inserted, a no-card warning appears on the LCD monitor; the shutter can still be released, but no image is captured.

1. Slide the card-chamber door toward the back of the camera to release the safety catch. Open the door.
2. Insert the memory card all the way into the card slot and then release. The card should catch in the slot.

Insert the card so the face is toward the back of the camera. Always push the card in straight, never at an angle. Never force the card. If the card does not fit, check that it is orientated correctly. If a MultiMediaCard is inserted incorrectly, it will lock, but the card chamber door will not close.

3. To eject a memory card, press the card into the slot and release. The card can now be pulled out.
4. Close the card-chamber door and slide it toward the camera to engage the safety catch.

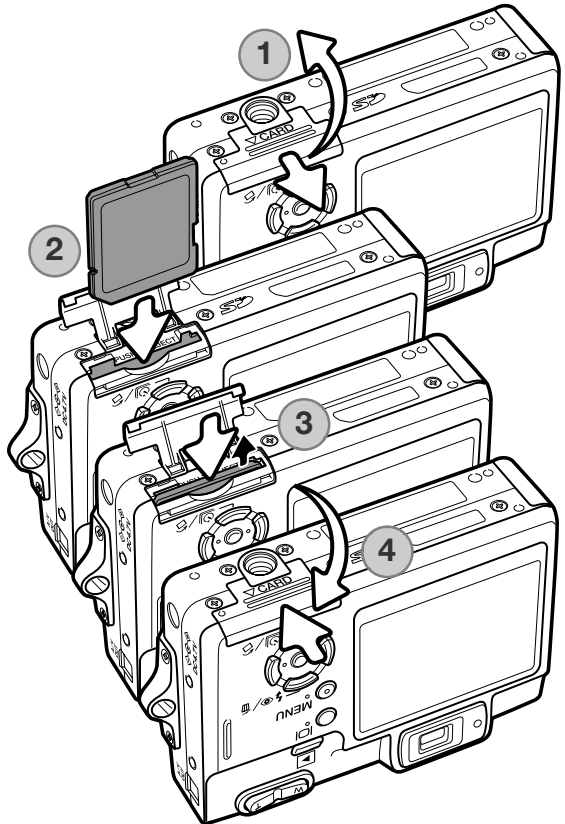

ABOUT MEMORY CARDS

The response time during recording and playback is longer with MultiMediaCards compared with SD Memory Cards. This is not a defect, but rather due to the specifications of the cards. When using large capacity cards, some operations like deletion may take longer.

The SD Memory Card has a write-protect switch to prevent image data from being deleted. By sliding the switch to the bottom of the card, the data will be protected. However, when the card is protected, images cannot be recorded. If an attempt is made to record or delete an image with the camera, the card-locked message will appear and the LED lamps near the viewfinder will turn orange and blink quickly. For memory card care and store see page 103.

If the unable-to-use-card message appears, the inserted card in the camera may need to be formatted. A card used in another camera may also have to be formatted before being used. A card can be formatted in section 1 of the setup menu (p. 70). When a card is formatted, all the data on the card is permanently erased.

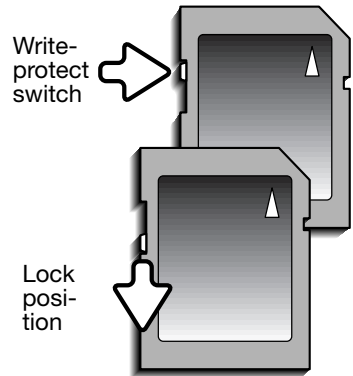

TURNING THE CAMERA ON

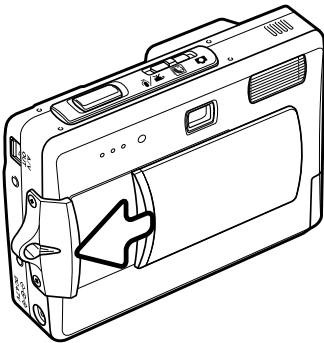

To turn the camera on, slide the lens cover open in the direction indicated in the illustration. When the camera is initially turned on, the date and time need to be set, see the following page. The monitor may turn off for a few seconds while the flash charges when the camera is turned on.

Slide the lens cover in the opposite direction to turn off the camera. Always store and transport the camera with the lens cover closed.

SETTING THE DATE AND TIME

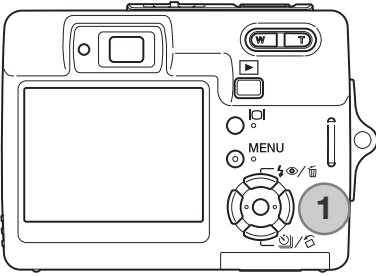

After initially inserting a memory card and batteries, the camera's clock and calendar must be set. When images are recorded, the image data is saved with the date and time of recording.

If the clock and calendar have not been set, a message is displayed for a few seconds each time the camera is turned on. This message is also displayed if the clock and calendar reset when the camera is stored without batteries for a long period.



Use the left and right keys of the controller (1) to select "Yes." "No" cancels the operation.



Press the center of the controller to open the date/time setup screen.

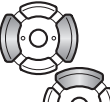
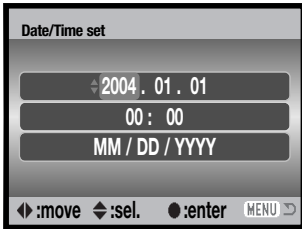

Use the left and right keys to select the item to be changed.



Use the up and down keys to adjust the item.



Press the central button to set the clock and calendar.

Date/Time setup screen

The date/time setup screen can be opened in section 2 of the setup menu. For customers in certain areas, the menu language must also be set. The language is changed in section 1 of the setup menu (p. 70, 74).

RECORDING MODE - BASIC OPERATION

This section covers basic recording operation. To prepare the camera for use, read pages 14 through 20.

HANDLING THE CAMERA

While using the viewfinder or LCD monitor, grip the camera firmly with your right hand while supporting the camera body with your left. Keep your elbows at your side and your feet shoulder-width apart to hold the camera steadily.

When taking vertical pictures, hold the camera so that the flash is above the lens with the shutter-release button to the bottom. Take care not to cover the lens with your fingers or the strap.

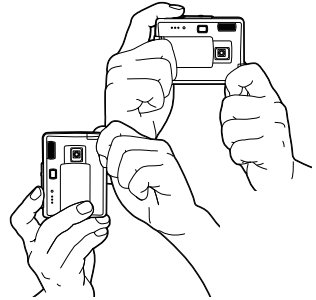

SETTING THE CAMERA TO RECORD IMAGES

Slide the mode switch to the appropriate position.

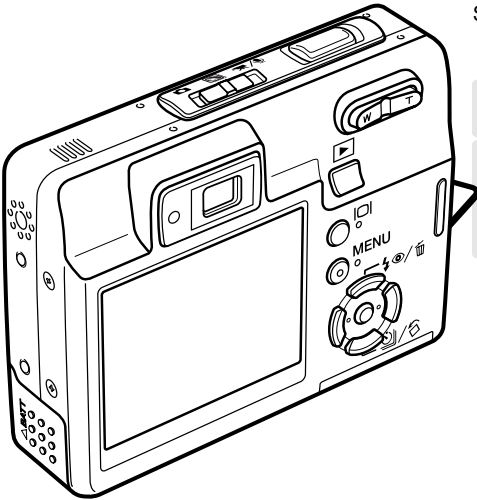

	Still-image recording.
	Digital Subject Programs.
	Movie and audio recording (p. 36, 52).

LCD MONITOR DISPLAY

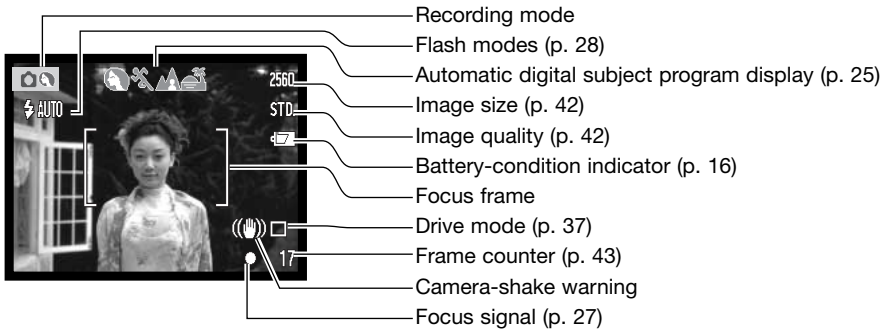

CAMERA-SHAKE WARNING

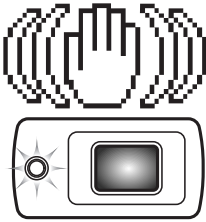

If the shutter speed falls below the point where the camera can be hand held safely, the camera-shake warning indicator will appear on the monitor and the viewfinder indicator lamp will turn orange and blink slowly. Camera shake is slight blurring caused by subtle hand motion and is more pronounced at the telephoto position of the lens than at the wide-angle position. Although the warning appears, the shutter can still be released. If the warning appears, place the camera on a tripod or use the built-in flash.

USING THE ZOOM LENS

This camera is equipped with a unique 6.1 - 17.1mm zoom lens. This is equivalent to a 37 to 105mm lens on a 35mm camera. The lens is operated by the zoom lever at the back of the camera. The effect of the optical zoom is visible in both the viewfinder and LCD monitor.

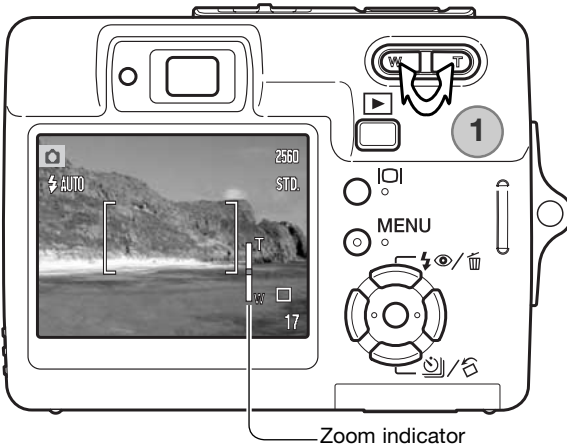

To zoom in on the subject, push the the right side (T) of the zoom lever (1).

To zoom out, push the the left side (W) of the zoom lever.

After zooming, the zoom indicator is displayed on the LCD monitor to show the approximate zoom position.

The digital-zoom function can increase the power of the lens. The digital zoom is activated in section 3 of the recording menu (p. 40).

Shooting tips

The zoom lens not only affects how large the subject is in the picture, but it also influences the depth of field and perspective. Depth of field is the area between the closest object in focus and the furthest object in focus. As the lens zooms in to the telephoto position, the depth of field becomes shallower, separating the subject from the background. Many portraits are taken with telephoto lenses. Zooming the lens out to the wide-angle position makes both the foreground and background appear sharper. Usually landscape photographs take advantage of the large depth of field of wide-angle lenses. Wide-angle lenses also create a strong perspective which gives a sense of depth in the image. Telephoto lenses compress the space between the subject and background and create a weak perspective.

BASIC RECORDING OPERATION

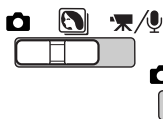

Slide the mode switch to the digital-subject-program or recording position. The operation for both modes is the same. Automatic Digital Subject Program Selection is only active in the digital-subject-program mode.

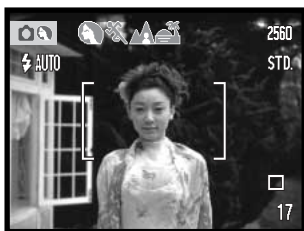

Place the subject anywhere within the focus frame. Make sure the subject is within the focus range of the lens (p. 26). If the subject is closer than 1m (3ft.) at the zoom lens' wide-angle position or 3m (10ft) at the telephoto position, use the LCD monitor to frame the subject.



Press the shutter-release button partway down to lock the focus and exposure. Automatic Digital Subject Selection will choose the appropriate exposure mode, see the facing page.

The monitor focus signal is white and viewfinder indicator lamp turns green to confirm focus lock. If the focus signal is red or the indicator lamp blinks, the camera was unable to locate the subject. Repeat the previous steps.

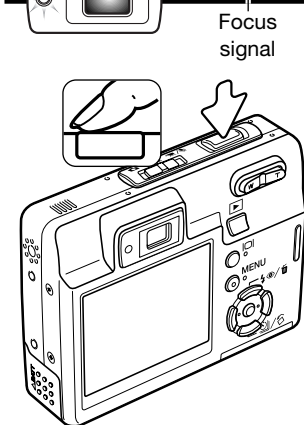

Press the shutter-release button all the way down to take the picture. The recorded image can be previewed by continuing to hold down the shutter-release button after the image is captured. The instant-playback function can also be used (p. 47).

The viewfinder indicator lamp turns red and blinks indicating data is being written to the memory card. Never remove a memory card while data is being transferred.

AUTOMATIC DIGITAL SUBJECT PROGRAM SELECTION

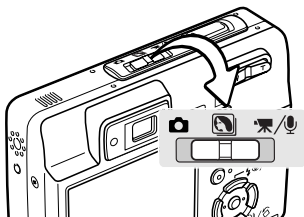

Automatic Digital Subject Program Selection chooses between program AE and one of four digital subject programs. The digital subject programs optimize camera setting for various conditions and subjects. Automatic Digital Subject Program Selection is only available in the digital-subject-program mode. For information on individual subject programs, see page 30.



A row of gray indicators at the top on the monitor display indicate Automatic Digital Subject Program Selection is active.

Press the shutter-release button partway down; the AF system locates the subject and the Automatic Digital Subject Program Selection chooses a subject program. If no indicators are displayed, programmed AE is active. Press the shutter-release button all the way down to take the picture.

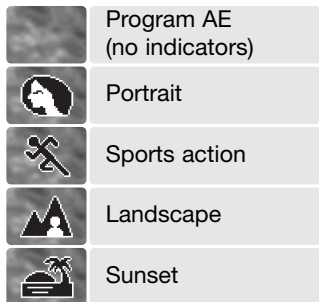

Hold the camera steadily when the sunset subject program is selected as exposures can be long.

In the digital-subject-program mode, one of seven digital subject programs can be selected manually by using the left and right keys of the controller before taking a picture. See page 30.

FOCUS LOCK

The focus-lock function is used when you want to compose the image with the subject off-center and outside the focus frame. Focus lock may also be used when a special focusing situation prevents the camera from focusing on the subject. This function is controlled with the shutter-release button.



Place the subject within the monitor focus frame or center the subject in the viewfinder. Press and hold the shutter-release button partway down to lock the focus.

The focus signal on the monitor and the green viewfinder indicator lamp will indicate if the focus is locked.

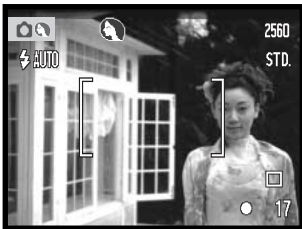
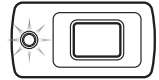

Without lifting your finger from the shutter-release button, recompose the subject within the image area. Press the shutter-release button all the way down to take the picture.

FOCUS RANGE

The focus range is 10cm (4 in.) to infinity. Both the LCD monitor and viewfinder can be used to frame the subject. However, because of parallax, only the monitor's live image will be accurate with subjects closer than 1m (3ft.) at the zoom lens' wide-angle position or 3m (10ft) at the telephoto position.

FOCUS SIGNALS

This digital camera has a quick, accurate autofocus system. The focus signal in the lower right corner of the LCD monitor and the indicator lamp next to the viewfinder indicate the focus status. The shutter can be released regardless if the camera can focus on the subject or not.

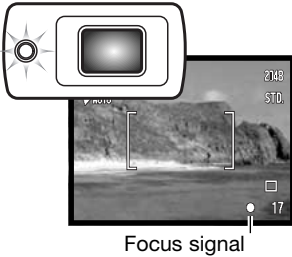

Focus confirmed - the LCD monitor focus signal is white, the viewfinder indicator lamp is green and steady. Focus is locked.

Cannot focus - the LCD monitor focus signal is red and the viewfinder indicator lamp is green and blinks rapidly.

SPECIAL FOCUSING SITUATIONS

The camera may not be able to focus in certain situations. In these situations the focus-lock function (p. 26) can be used to focus on another object at the same distance as your main subject, and then the image can be recomposed to take the picture.

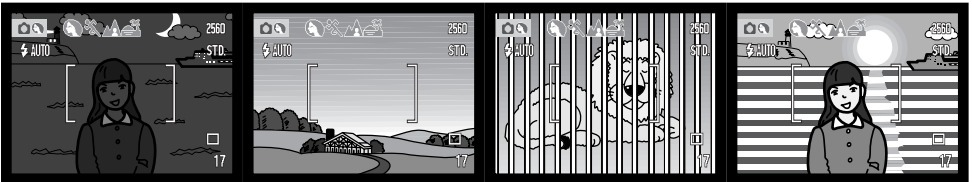

The subject is too dark.

The subject in the focus frame is low in contrast.

Two subjects at different distances overlap in the focus frame.

The subject is near a very bright object or area.

FLASH MODES

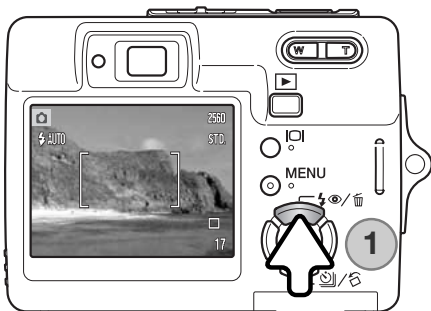

The flash can be used when taking still images. To select the flash mode, press the flash mode button (1) on the back of the camera until the desired mode is displayed. Press the shutter-release button to set the mode. The active flash mode is displayed in the top left corner of the LCD monitor. When the camera is turned off and auto reset (p. 45) is active, the flash mode is reset to autoflash with red-eye reduction if this mode was last used, if not the mode will be reset to autoflash. While the flash is charging, the shutter cannot be released.

Autoflash - the flash fires automatically in low-light and backlit conditions.

Red-eye reduction - the flash fires multiple bursts before the main flash burst to reduce red-eye; an effect caused by light reflected from the retina. Use in low-light conditions when taking photographs of people or animals, the pre-flashes contract the pupils of the subject's eyes.

Fill flash - the flash fires with each exposure regardless of the amount of ambient light. Fill flash can be used to reduce harsh shadows caused by strong direct light or sunshine.

Flash cancel - the flash will not fire. Use flash cancel when flash photography is prohibited, natural light is desired to illuminate the subject, or the subject is beyond the flash range. The camera-shake warning may appear when flash cancel is selected (p. 22).

	Autoflash
	Autoflash with red-eye reduction
	Fill-flash
	Flash cancel



Fill flash

FLASH RANGE - AUTOMATIC OPERATION

The camera automatically controls the flash output. For well-exposed images, the subject must be within the flash range. Because of the optical system, the flash range is not the same at the lens' wide-angle position as it is at the telephoto position. The flash range can be changed with camera sensitivity (ISO), see page 46.

Wide-angle position	Telephoto position
0.2m ~ 3.2m (0.6 ft. ~ 10.5 ft.)	0.1m ~ 1.8m (0.4 ft. ~ 5.9 ft.)

FLASH SIGNALS

The indicator lamp next to the viewfinder indicates the status of the flash. When the lamp is orange and blinks quickly, the flash is charging and the shutter will not release. The lamp glows steadily for three seconds when the flash is charged.

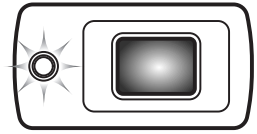

DISPLAY BUTTON - RECORDING MODE

The display button controls the LCD monitor display. The display cycles to the next position each time the button is pressed: full display, live image only, and monitor off. The monitor cannot be turned off for movie/audio recording. If the display button is pressed and held, the LCD-brightness adjustment screen is displayed, see page 72.

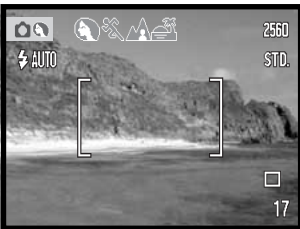

Full display



Live image only

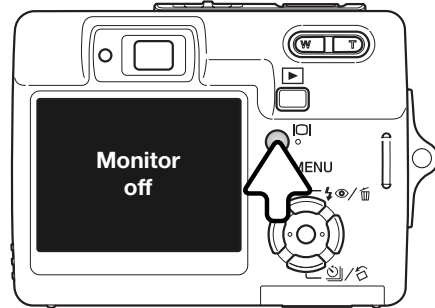

DIGITAL SUBJECT PROGRAMS

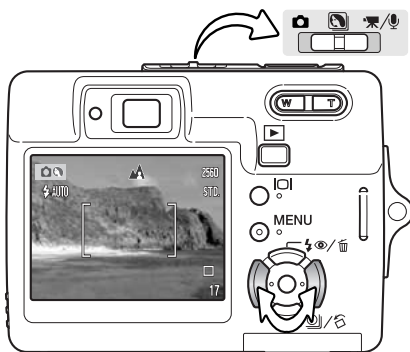

Digital subject programs optimize the camera's exposure, white-balance, and image-processing systems for specific conditions and subjects.

Set the mode switch to the Digital subject Program position. Simply press the left and right keys of the controller to select the appropriate subject program; the active subject program is displayed at the top of the monitor. For more on Automatic Digital Subject Program Selection, see page 25.

	Automatic selection
	Portrait
	Sports Action
	Landscape
	Sunset
	Night Portrait
	Text
	Super Macro
	Auto recording (off)

Portrait - optimized to reproduce warm, soft skin tones and a slight defocusing of the background. Most portraits look best at a telephoto setting; the longer focal length does not exaggerate facial features and the shallower depth of field softens the background. Use fill flash with strong direct sunlight or backlight to reduce harsh shadows.

Sports action - used to capture action by maximizing shutter speeds. When using flash, the subject must be within the flash range (p. 29). A monopod is more flexible and compact than a tripod when shooting events.

Landscape - optimized to produce sharp, colorful landscapes. Used with bright outdoor scenery.

Sunset - optimized to reproduce rich, warm sunsets. When the sun is above the horizon, do not point the camera toward the sun for prolonged periods of time. The intensity of the sun could damage the CCD. Between exposures, turn off the camera or cover the lens.

Night portrait - for deep, subtle night scenes. The use of a tripod is recommended. When used with flash, the subject and background exposures are balanced. The flash can only be used with close subjects such as with a portrait of a person. When using the flash, ask your subjects not to move after the burst; the shutter may still be open for the background exposure.

Text - To take pictures of black text or line art on white backgrounds.

Super Macro - for close-up photographs down to 6cm (2.4 in.). When selected, the lens zooms automatically to the Super Macro position; the zoom position cannot be changed. At close object distances, the flash may cause overexposure or uneven illumination, set the flash mode to flash cancel (p. 28). The use of a tripod is recommended.

Auto recording - when the Digital Subject Programs are turned off, the camera uses programmed autoexposure.

SPOT AF

The spot AF is used for selective focusing. Both focus and exposure are determined with the spot focus area. When auto reset (p. 45) is active, the spot AF area resets to the wide focus frame when the camera is turned off. The spot focus area can be used with movie recording. When used with the digital zoom (p. 51), the spot focus area is enlarged.

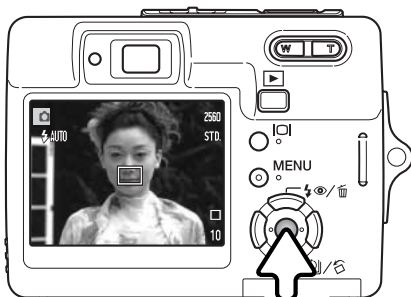

Press and hold the center button of the controller to display the spot focus area; press and hold the button again to return to the wide focus frame. Take the picture as described in the basic recording operation section on page 24.

When the LCD monitor is off, the camera cannot be switched between wide and spot AF; the last AF mode set is active. When the live image only display is used, switching between the wide and spot AF modes resets the display mode to the full display.

PLAYBACK - BASIC OPERATION

Images can be viewed in the playback mode. The playback mode has additional functions, see page 54. The camera does not need to be turned on with the lens cover to play back images.

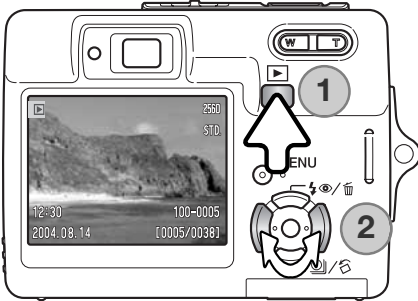

To view recorded images, press the playback button (1). If the camera is off, continue to press the button until the monitor activates.

Use the left / right keys of the controller to scroll through the images on the card (2).

Press the playback button again to return to the recording mode or turn the camera off.

SINGLE-FRAME PLAYBACK DISPLAY

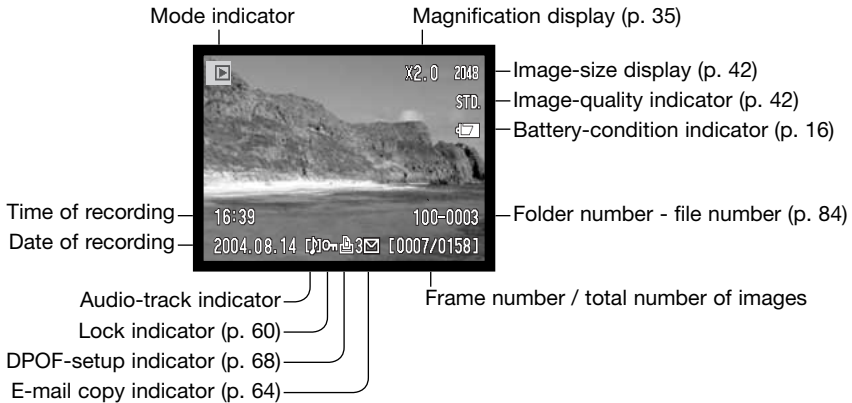

ROTATING IMAGES

Press the down key of the controller (1) to rotate the displayed image 90° left, 90° right, and horizontally. The image is displayed in the selected orientation until changed.

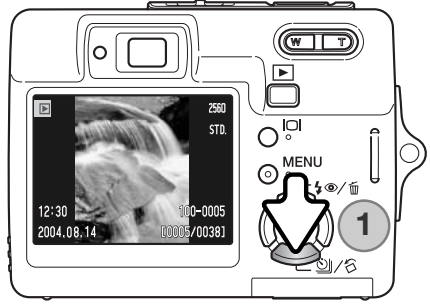

DELETING SINGLE IMAGES

To delete a displayed file, press the up key of the controller (1). A confirmation screen appears.

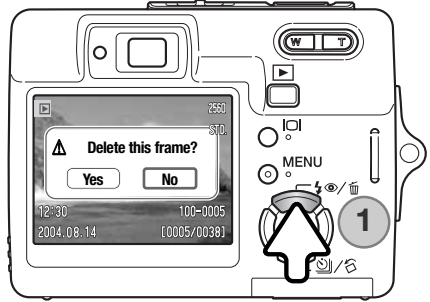

Use the left/right keys to select “Yes.” “No” cancels the operation.



Press the center button of the controller to delete the file.

DISPLAY BUTTON - PLAYBACK MODE

The display button controls the display format. Each time the button is pressed, the display cycles through to the next format: full display, image only, index playback.

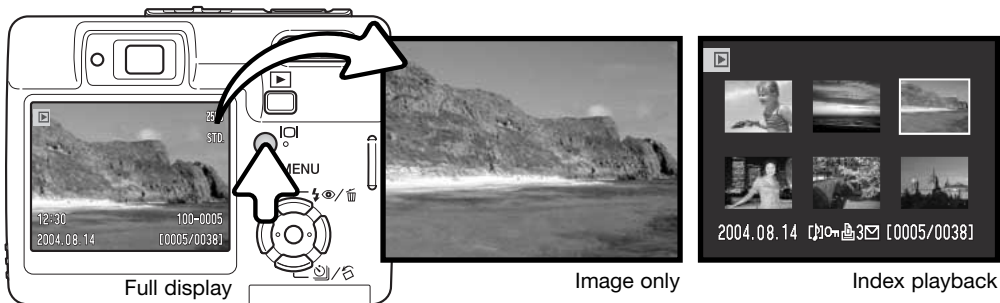

In index playback, the left/right and up/down keys of the controller move the yellow border around the index thumbnails. When the image is highlighted with the border, the date of recording, audio-track indicator, the lock and printing status, e-mail copy indicator and the frame number of the image are displayed at the bottom of the screen. The accompanying audio track of the highlighted image can be played by pressing the center button of the controller. When the display button is pressed again, the highlighted image is displayed in the single-frame playback mode.

ENLARGED PLAYBACK

In single-frame playback, a still image can be enlarged by up to 6X in 0.2X increments.

With the image to be magnified displayed, press the right side of the zoom lever (T) to activate the enlarged playback mode. The degree of magnification is displayed on the LCD monitor.

Press the right side of the zoom lever (T) to increase the image magnification. Press the left side of the lever (W) to decrease the magnification.

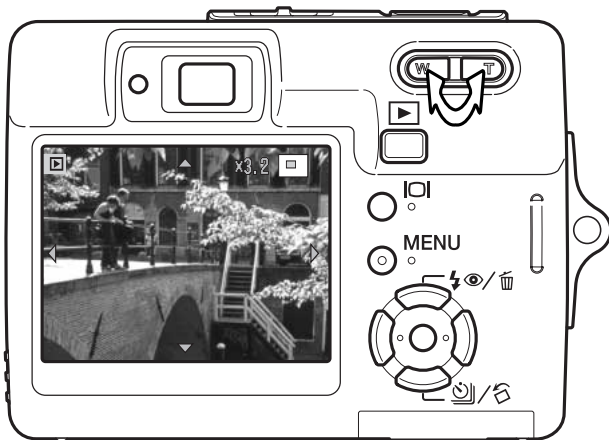

Use the four-way keys of the controller to scroll the image. When scrolling, the arrows in the display disappear when the edge of the image has been reached.

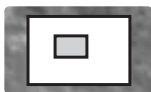

The locator in the top right corner of the monitor indicates the area of the image being displayed.



The display button switches between showing the full display and the image only.

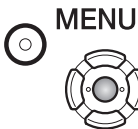

To exit enlarged playback, press the menu button or the central button of the controller.

RECORDING - ADVANCED OPERATION

MOVIE RECORDING

This camera can record digital video with sound. Simply slide the mode switch to the movie/audio recording position (1). Total recording time varies with the frame rate and the memory card capacity, see page 53. Some changes can be made with the movie menu (p. 40).

Place the subject in the focus frames and press the shutter-release button partway down to lock focus (2). Press the shutter-release button all the way down and release to begin recording (3).

A digital zoom is available during recording. The camera continues to record until the recording time is used or the shutter-release button is pressed again.

When recording, the frame counter displays the elapsed time. During the last ten seconds, the counter turns red and counts down the time.

Take care not to cover the microphone while recording.

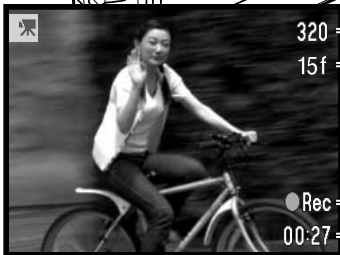
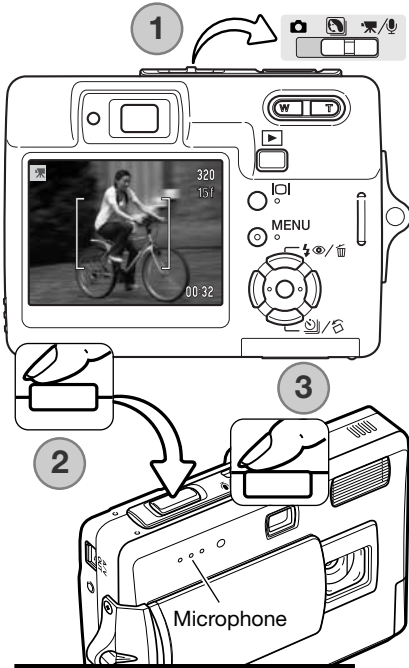



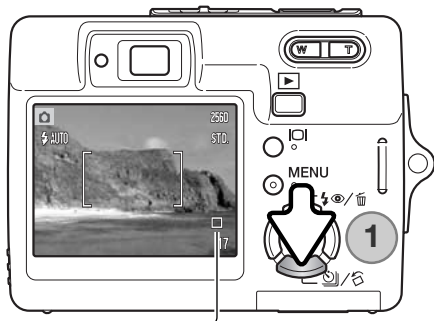

- 320 — Image size
- 15f — Frame rate
- Rec — Recording indicator
- 00:27 — Recording time



DRIVE MODES

The drive modes control the rate and method images are captured. Indicators indicating the selected drive mode appear on the monitor. If auto reset (p. 45) is active, the drive mode is reset to single-frame advance when the camera is turned off.

Press the down key of the controller to select the drive mode (1).

-  Single-frame advance - to take a single image each time the shutter-release button is pressed. This is the camera's default setting.
-  Self-timer - to delay the release of the shutter (p. 38). Used for self-portraits.
-  Continuous advance - to take up to four images when the shutter-release button is pressed and held (p. 39).
-  UHS continuous advance - to take eleven 1280x960 size images in one second when the shutter-release button is pressed and held (p. 39).
-  Multi Frame - to create a composite image of a nine-frame series when the shutter-release button is pressed once, see below.

Multi Frame

Take the picture as described in the basic recording operation section (p. 24). Once the series starts, the shutter button can be released; the camera continues recording until all nine frames have been captured.

Flash cannot be used. Because of the limits to the shutter speeds, images may be underexposed in low-light conditions. Image size refers to the total area of all nine images, not the size of each individual thumbnail.



Self-timer

Used for self-portraits, the self-timer delays the release of the shutter for approximately ten seconds after the shutter-release button is pressed. The self-timer drive mode is selected with the down key of the controller (p. 37).

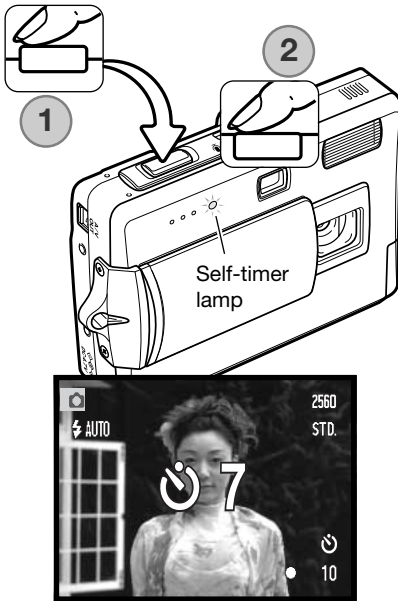

With the camera on a tripod, compose the picture as described in the basic recording operation section (p. 24). Press the shutter-release button partway down to lock the exposure and focus (1). Press the shutter-release button all the way down to begin the countdown (2). Because focus and exposure are determined when the shutter-release button is pressed, do not stand in front of the camera when taking a self-timer image. Always confirm the focus with the focus signals before beginning the countdown (p. 27).

During the countdown, the self-timer lamp on the front of the camera starts to blink and is accompanied by an audio signal. A countdown timer is displayed on the monitor. A few seconds before the exposure, the self-timer lamp blinks rapidly. The lamp glows steadily just before the shutter fires.

To stop the countdown, press the zoom lever or menu button. The drive mode resets to single-frame advance after the exposure. The audio signal can be turned off in section 2 of the setup menu (p. 70).

Continuous advance & UHS continuous advance

These drive modes are selected with the down key of the controller (p. 37).

Compose the picture as described in the basic recording operation section (p. 24). Press the shutter-release button partway down (1). Press and hold the shutter-release button all the way down (2) to begin taking pictures. When the shutter-release button is pressed and held, the camera begins recording images until the maximum number has been taken or the shutter button is released. The frame counter is adjusted after the series has been taken.

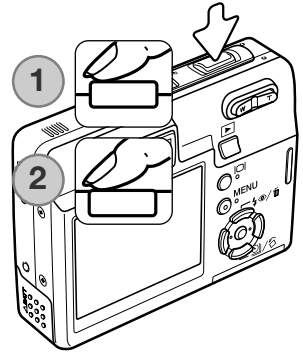

Continuous-advance - to take up to four images when the shutter-release button is pressed and held. With the image-size setting of 2560 x 1920, the maximum rate of capture is 1.9 fps.

The built-in flash can be used, but the rate of capture is reduced because the flash must recharge between frames. Date imprinting (p. 50) also reduces the rate of capture.

UHS continuous-advance - to capture up to eleven 1280x960 images in one second regardless of the image-quality setting. A thumbnail of each frame in the series is shown six at a time while being saved. The built-in flash cannot be used. When the red low-battery warning is displayed, this drive mode cannot be used. Very bright light sources in the scene may cause streaks to appear on the image. Black areas caused by data loss may also be apparent.

NAVIGATING THE RECORDING MENUS

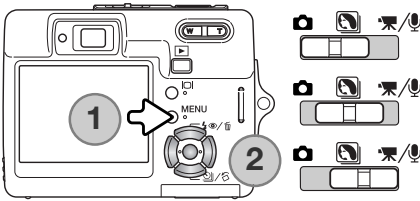

The recording menu displayed varies with the position of the mode switch. Pressing the menu button (1) turns the menu on and off. The four-way keys of the controller (2) move the cursor in the menu. Pressing the central button of the controller enters a setting.

 **MENU** Activate the menu with the menu button.



Use the left/right keys of the controller to highlight the appropriate menu tab; the menu changes as the tabs are highlighted.



Use the up/down keys to scroll through the menu options. Highlight the option whose setting needs to be changed.

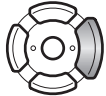

With the menu option highlighted, press the right controller key; the settings are displayed with the current setting highlighted. To return to the menu options, press the left key.



Use the up/down keys to highlight the new setting.

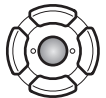

Press the central button of the controller to select the highlighted setting; some options open a selection screen.

Once a setting has been selected, the cursor returns to the menu options and the new setting is displayed. To return to the recording mode, press the menu button.

Still image recording

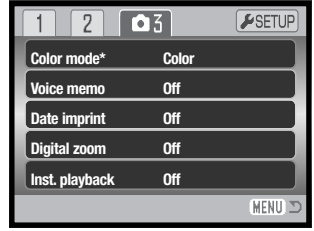
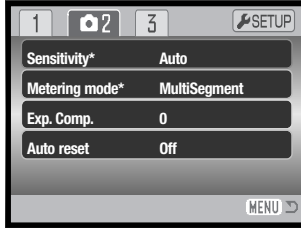
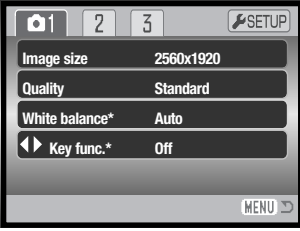

* White balance, custom key function, camera sensitivity, metering mode, and color mode options are not active when the mode switch is in the digital-subject-program position.

Movie and audio recording

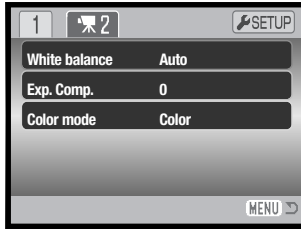
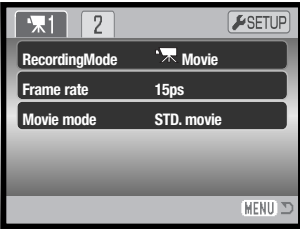

Refer to the following sections for details on the menu options and their settings.

Index to menu functions

Auto reset, 45
 Color mode, 43
 Date imprinting, 50
 Digital zoom, 51
 Exp. compensation, 48
 Frame rate, 53

Image size, 42
 Instant playback, 47
 Key function, 45
 Metering mode, 47
 Movie mode, 53
 Quality, 42

Recording mode, 52
 Sensitivity, 46
 Voice memo, 49
 White balance, 44

IMAGE SIZE AND IMAGE QUALITY

Changing image size affects the number of pixels in each image. The greater the image size, the larger the file size. Choose image size based on the final use of the image - smaller images are more suitable for web sites whereas larger sizes produce higher quality prints.

LCD monitor	Number of pixels (hor. X vert.)
2560	2560 X 1920
2048	2048 X 1536
1600	1600 X 1200
640	640 X 480

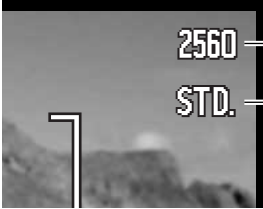

FINE	Fine - high-quality JPEG image.
STD.	Standard - the default setting. (JPEG)
ECON.	Economy - the smallest file sizes. (JPEG)

Image quality controls the rate of compression, but has no effect on the number of pixels in the image. The higher the image quality, the lower the rate of compression and the larger the file sizes. If economical use of the memory card is important, use the economy mode. Standard image quality is sufficient for normal usage. The fine mode produces the highest quality image and the largest image files.

Image size and quality must be set before the picture is taken. Changes are displayed on the LCD monitor. Image size and quality must be reset manually. Image size and quality are set in section 1 of the recording menu. See navigating the recording menu section on page 40.

If image size or quality are changed, the frame counter displays the approximate number of images that can be recorded at that setting on the installed memory card. One memory card can contain images with differing sizes and qualities. The number of images that can be stored on a memory card is determined by the size of the card and the file size of the images. The actual file size is determined by the scene; some subjects can be compressed further than others. See the chart on the following page.

Approximate file sizes.					
Quality	Size	2560 X 1920	2048 X 1536	1600 X 1200	640 X 480
Fine		2.4MB	1.6MB	1.0MB	200KB
Standard		1.2MB	820KB	520KB	130KB
Economy		650KB	440KB	290KB	90KB
Approximate number of images that can be stored on a 16MB memory card.					
Fine		5	8	14	68
Standard		11	17	27	99
Economy		21	31	47	148

Camera Notes

The frame counter indicates the approximate number of images that can be stored on the memory card at the camera's image quality and size settings. Because the counter uses approximate file sizes, the actual image taken may not change the counter or may decrease it by more than one. When the frame counter displays zero, it indicates no more images at the image size and quality settings can be captured. Changing those settings may allow more images to be saved to the card.

COLOR MODE

The color mode controls whether an image is color or black and white. The color mode is set in section 3 of the still-image recording menu or in section 2 of the movie/audio recording menu (p. 40). The color mode cannot be changed with digital subject programs. The color mode can be assigned to the controller (p. 45).

The black & white mode produces neutral monochrome images. Sepia creates warm-tone monochrome images. The monitor live image reflects the selected color mode. The color option uses no monitor indicator when active. The color mode has no effect on image file size.

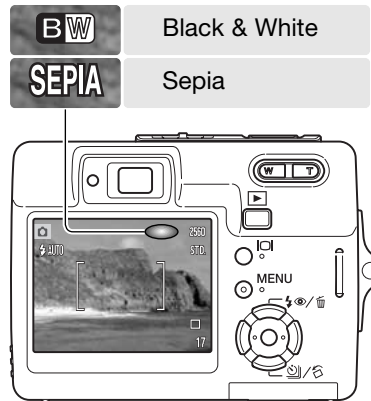





WHITE BALANCE

White balance is the camera's ability to make different types of lighting appear neutral. The effect is similar to selecting daylight or tungsten film, or using color compensating filters in conventional photography. One automatic and four preset white-balance settings are available with still image and movie recording; white balance cannot be changed with digital subject programs. White balance is set in section 1 of the recording menu or in section 2 of the movie/audio recording menu (p. 40). Exposure compensation can be assigned to the controller (p. 45). When auto reset (p. 45) is active, the white balance is reset to automatic when the camera is turned off.

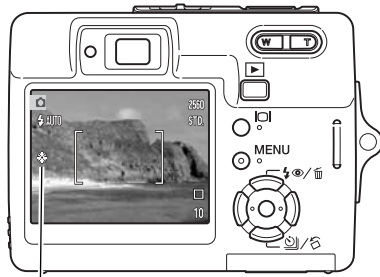
Automatic white balance compensates for the color temperature of a scene. In most cases, the auto setting balances the ambient light and creates beautiful images, even under mixed-lighting conditions. When the built-in flash is used, the white balance is set to the color temperature of the flash.

When one of the preset white-balance settings is selected, an indicator is displayed on the LCD monitor to indicate the active white-balance setting; the effect is immediately visible on the monitor. To record the ambient light, set the flash mode to flash cancel (p. 28). The built-in flash can be used with preset white-balance, but creates a pinkish or blueish cast with the fluorescent and tungsten settings. The flash is daylight balanced and produces good results with the daylight and cloudy settings.



-  Daylight - for outdoor and sunlit subjects.
-  Cloudy - for overcast outdoor scenes.
-  Tungsten - for incandescent lighting: household light bulbs.
-  Fluorescent - for fluorescent lighting: office ceiling lights.

CUSTOM KEY FUNCTION

In the recording mode, a function can be assigned to the left/right keys of the controller. This function is specified in section 1 of the recording menu (p. 40). This function cannot be used with the movie/audio mode or digital subject programs. Refer to the following sections for information on exposure compensation (p. 48), white balance (p. 44), camera sensitivity (p. 46), and color mode (p. 43).

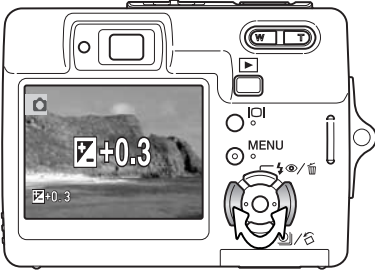

In the recording mode, use the left/right controller keys to change the function set with the menu.

The LCD monitor displays the settings as they are changed. The changes are visible in the monitor image. The function is set automatically after five seconds or when another camera button is pressed.

AUTO RESET

When auto reset is active, the following functions reset when the camera is turned off. This function can be turned off in section 2 of the recording menu (p. 40).

Flash mode (p. 28)	Autoflash
Drive mode (p. 37)	Single-frame advance
White balance (p. 44)	Auto
Camera sensitivity (p. 46)	Auto
Exposure compensation (p. 48)	0.0
Metering mode (p. 47)	Multi-segment
Color mode (p. 43)	Color
AF area (p. 31)	Wide focus frame
Monitor display (p. 29)	Full display

The flash mode is reset to auto-flash or autoflash with red eye reduction depending on which of those two flash modes were last set.

CAMERA SENSITIVITY - ISO

Five camera sensitivity settings can be selected with a still image: Auto, 50, 100, 200, 400; the numerical values are based on an ISO equivalent; the higher the number, the more sensitive the film. Sensitivity can be changed in section 2 of the recording menu (p. 40). This cannot be changed with movie recording or digital subject programs. Sensitivity can be assigned to the controller (p. 45).

The auto setting automatically adjusts the camera sensitivity to the light conditions between ISO 50 and ISO 160. When any other setting than auto is used, "ISO" and the set value appear on the LCD monitor.

A specific sensitivity setting can be selected. As the ISO value doubles, the camera sensitivity doubles. Like grain in silver-halide film that increases with speed, noise increases with the sensitivity in digital imaging; an ISO setting of 50 has the least noise and 400 has the most.

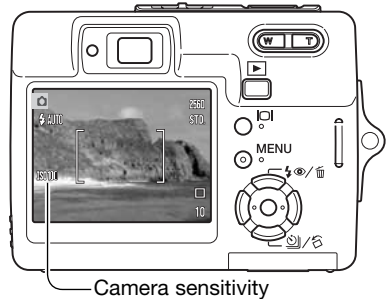

Camera Notes

Noise reduction is applied automatically to exposures of one second or longer. Processing is applied to each image after it is captured. The processing time varies from image to image; a processing message is displayed during this period.

FLASH RANGE AND CAMERA SENSITIVITY

Because of the optical system, the flash range is not the same at the lens' wide-angle position as it is at the telephoto position.

ISO setting	Flash range (wide angle)	Flash range (telephoto)
AUTO	0.2m ~ 3.2m (0.6ft. ~ 10.5ft)	0.1m ~ 1.8m (0.3ft. ~ 5.9ft)
50	0.2m ~ 1.8m (0.6ft. ~ 5.9ft)	0.1m ~ 1.0m (0.3ft. ~ 3.3ft)
100	0.2m ~ 2.5m (0.6ft. ~ 8.2 ft)	0.1m ~ 1.4m (0.3ft. ~ 4.6ft)
200	0.2m ~ 3.6m (0.6ft. ~ 11.8 ft)	0.1m ~ 2.0m (0.3ft. ~ 6.6ft)
400	0.25m ~ 5.0m (0.8ft. ~ 16.7 ft)	0.1m ~ 2.8m (0.3ft. ~ 9.2ft)

METERING MODES

The metering mode is selected in section 2 of the recording menu (p. 40). Metering cannot be changed with the movie recording or digital subject programs.

Multi-segment metering: uses 256 segments to measure luminance and color. This data is combined with distance information to calculate the camera exposure. This advanced metering system will give accurate worry-free exposures in almost all situations.

Spot metering: uses a small area within the image to calculate the exposure. When this mode is selected, the LCD monitor automatically activates if off and a small circle appears in the middle of the live image indicating the measuring area. The spot allows precise exposure measurements of a particular object without being influenced by extremely bright or dark areas within the scene. If the LCD monitor is turned off, the spot-metering mode remains active.

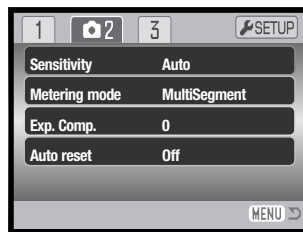

Spot-metering area

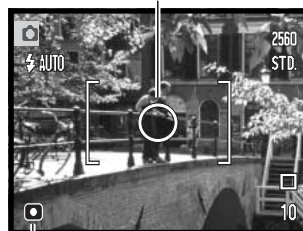

Spot-metering indicator

INSTANT PLAYBACK

After a still image is captured, it can be displayed on the monitor for two seconds before being saved. Instant playback shows the last frame in the series when used with the continuous-advance drive mode (p. 37). When the LCD monitor is turned off (p. 29), it activates automatically for the instant playback period.

Instant playback can be activated in section 3 of the recording menu (p. 40). When used with voice memo, the audio recording begins after the image is played back.

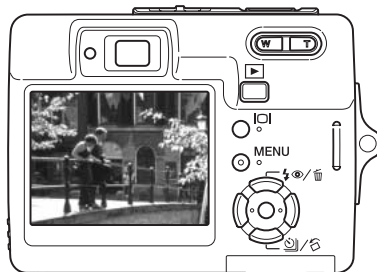

EXPOSURE COMPENSATION

The camera exposure can be adjusted to make the final picture lighter or darker by as much as $\pm 2\text{Ev}$ in $1/3$ increments with still image and movie recording; exposure compensation cannot be used with digital subject programs. When auto reset (p. 45) is active, exposure compensation is reset to 0.0 when the camera is turned off. Exposure compensation can be assigned to the controller (p. 45).

Select the exposure compensation option in section 2 of the recording menu. Use the up/down keys to adjust the degree of compensation (1); the live image behind the menu reflects the change. Press the central controller button to set this value (2). If any value other than 0.0 is set, an indicator is displayed on the monitor as a warning.

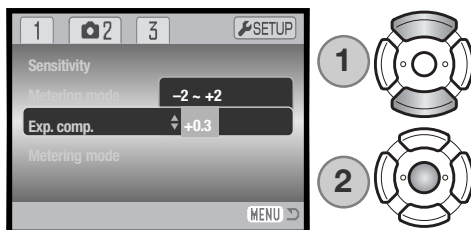

Shooting tips

Sometimes the camera's exposure meter is deceived by certain conditions. Exposure compensation can be used in these situations. For example, a very bright scene, such as a snowy landscape or a white sandy beach, can appear too dark in the captured image. Before taking the picture, adjusting the exposure by +1 or +2 EV results in an image with normal tonal values.



Calculated camera exposure



-1.0Ev



-2.0Ev

In the example above, the dark water caused the camera to overexpose the image making it bright and washed-out. By compensating the exposure, detail is brought out in the leaves, and the stones and water appear richer. For more on Ev, see page 105.

VOICE MEMO

Voice memo allows an audio track up to fifteen second to be recorded with a still image. The function is activated in section 3 of the recording menu (p. 40). When the function is active, the microphone indicator (1) is displayed in the top left corner of the monitor. The voice memo must be set before taking a picture. It remains in effect until reset.

After an image is captured, a screen appears indicating the audio recording has started. A bar graph displays the amount of recording time elapsed.

To stop the recording, press the shutter-release button or the center button of the controller (2). The recording will stop automatically when the fifteen-second limit has elapsed.

A voice memo is attached to the last image of a continuous-advance series (p. 37). When played back, images with voice-memo audio tracks have a note indicator displayed with them (p. 54). A voice memo can be deleted from an image in section 1 of the playback menu (p. 56).



Camera Notes

When making audio recordings, be careful not to touch or cover the microphone. The quality of the recording is proportional to the subject to microphone distance. For best results, hold the camera approximately 20cm (8in) from your mouth.

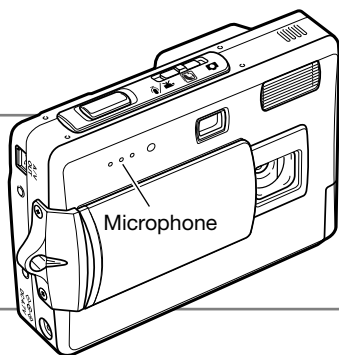

DATE IMPRINTING

The date and time of recording can be printed directly on a still image. The imprinting function must be activated before the image is taken. Once activated, the date will continue to be imprinted until the function is reset; a yellow bar is displayed behind the frame counter on the monitor to indicate the imprinting function is active.

Date imprinting is activated with section 3 of the recording menu (p. 40). Date imprinting has two menu options. The YYYY/MM/DD option prints the date. The MM/DD/hr:min option prints the month, day, and time of recording.

The date and time are imprinted in the lower right corner of the image when viewed horizontally. It is printed directly on the photograph writing over the image information. The date can be imprinted in three formats: year / month / day, month / day / year, and day / month / year. The date and date format are set in section 3 of the setup menu (p. 70).

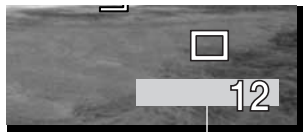

Date-imprinting indicator



Camera Notes

Every time a still image is recorded, it is stored with an exif tag that contains the date and time of recording as well as shooting information. This information can be viewed with the camera in the playback mode, or on a computer with the DiIMAGE Viewer software.

DIGITAL ZOOM

The digital zoom is activated in section 3 of the recording menu (p. 40). The digital zoom increases the magnification of the greatest telephoto setting of the optical zoom by up to 4.3X in 0.1X increments. Although the images recorded with the digital zoom are interpolated to the set image size, the quality of the images may not be equal to images taken without the digital zoom; the greater the power of the digital zoom the lower the image quality. The effect of the digital zoom is visible on the LCD monitor only. The digital-zoom function is canceled if the LCD monitor is turned off (p. 29).

At the maximum telephoto position, continue to press the right side (T) of the zoom lever (1) to engage the digital zoom. The zoom magnification is displayed in the top right corner of the monitor. To zoom out, press the the left side (W) of the zoom lever. After zooming, the zoom indicator is displayed on the LCD monitor to show the approximate zoom position.

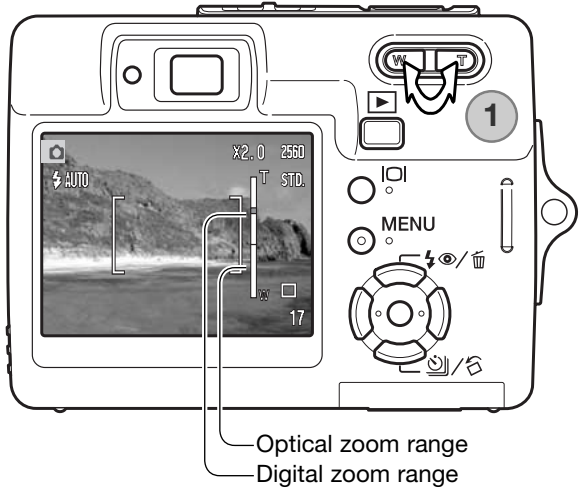

RECORDING MODE

The recording-mode menu options switches between movie and audio recording. This option is located in section 1 of the movie/audio menu (p. 40).

AUDIO RECORDING

Audio can be recorded without an image. About 30 minutes of audio can be stored on a 16MB memory card. Audio is recorded at approximately 8KB/s. A maximum of 180 minutes can be recorded at one time; the optional AC adapter is required for long recordings.

Slide the mode switch to the movie/audio recording position. In section 1 of the menu, change the recording mode to audio, see page 40.

Before recording, the approximate recording time available is displayed on the frame counter. To begin recording, press and release the shutter button.

The frame counter counts down the time. The recording stops when the shutter-release button is pressed again or the remaining time has elapsed.

When making audio recordings, be careful not to touch or cover the microphone. The quality of the recording is proportional to the subject to microphone distance. For best results, hold the camera approximately 20cm (8in) from your mouth.

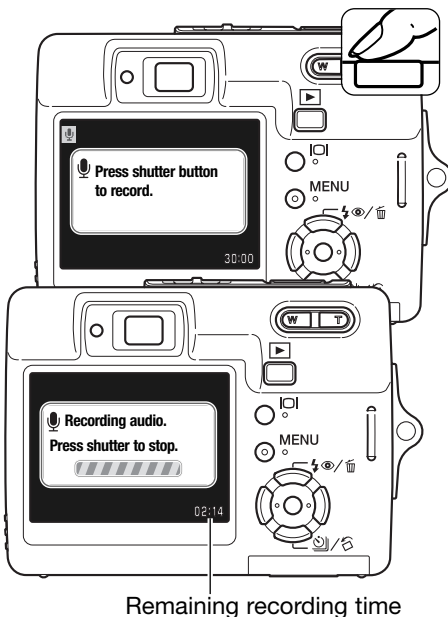

FRAME RATE & MOVIE FILE SIZES

Movies can be recorded at two frame rates: 15 fps and 30 fps. The higher the frame rate, the smoother the moving image and the larger the file sizes. Frame rate is set in section 1 of the movie menu (p. 40).

If image size or frame rate is changed, the frame counter displays the approximate number of seconds that can be recorded with the installed memory card. The total time that can be stored on a memory card is determined by the size of the card and the recording rate. The actual file size is determined by the scene; some subjects can be compressed further than others. The writing speed of the memory card may prematurely end the recording of a movie clip.

Approximate recording rate	
30 fps	670KB/s
15 fps	340KB/s
16MB memory card storage capacity (approx.)	
30 fps	21 seconds
15 fps	40 seconds

MOVIE MODE

The movie mode option selects the type of movie recorded. Standard produces a normal movie clip. Night Movie uses high camera sensitivity to record under low light levels; camera sensitivity increases automatically in low light. Image quality can be lower with Night Movies because of the higher sensitivity. The movie mode is set in section 1 of the movie menu (p. 40).

PLAYBACK - ADVANCED OPERATION

The basic functions in this mode are described in the basic playback section on pages 32 through 35. This section covers how to playback movie clips and audio tracks as well as the advanced function on the playback menu.

PLAYING BACK VOICE MEMOS AND AUDIO CAPTIONS



When a voice memo (p. 49) or audio caption (p. 59) is attached to a still image, the play guidance bar is displayed at the top of the monitor.



Press the central button of the controller to start the audio playback.



Playback time is displayed at the top of the image. The display returns to the playback mode when the audio track finishes. Pressing the menu button cancels the playback.



During playback, the up/down keys of the controller adjust the volume.

Camera Notes



When playing back audio or movie files, pressing the display button hides and shows the guidance display.

PLAYING BACK MOVIES AND AUDIO RECORDINGS

Movie clips and audio recordings are played back the same way. Use the left/right keys of the controller to display the movie or audio file; audio files are displayed with a blue screen.



Audio file



Press the center of the controller to play back a movie or audio file.

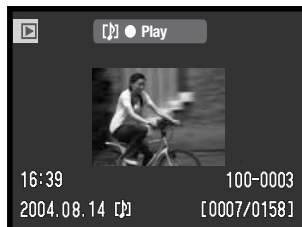

Movie file



Press the controller to pause and restart the movie or audio playback.



MENU To cancel the playback, press the menu button.



During playback, the up/down keys adjust the volume and the left/right keys rewind and fast forward the recording.

When the movie is paused, the displayed frame can be copied and saved as a still image. Press the up key of the controller to capture the frame; a confirmation screen appears. When saved, the file name of the captured image is displayed; press the center controller button to finish. For more on frame capture, see page 65.



NAVIGATING THE PLAYBACK MENU

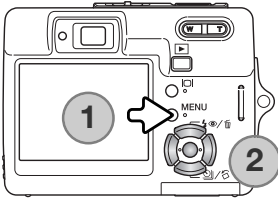

Navigating the menu is simple. The menu button turns the menu on and off (1). The left/right and up/down keys of the controller (2) control the cursor and change settings on the menu. Pressing the center button of the controller selects menu options and sets adjustments.

 **MENU** Activate the menu with the menu button.



Use the left/right keys of the controller to highlight the appropriate menu tab; the menu changes as the tabs are highlighted.



Use the up/down keys to scroll through the menu options. Highlight the option whose setting needs to be changed.

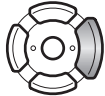

Press the right controller key to display the settings with the current setting highlighted. To return to the menu options, press the left key. If "Enter" is displayed, press the center button to display the setting screen.



Use the up/down keys to highlight the new setting.



Press the central button of the controller to select the highlighted setting.

Once a setting has been selected, the cursor returns to the menu options and the new setting is displayed. To return to the playback mode, press the menu button.

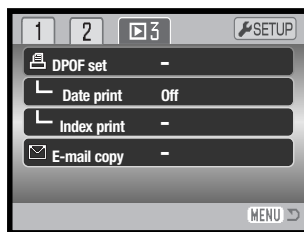
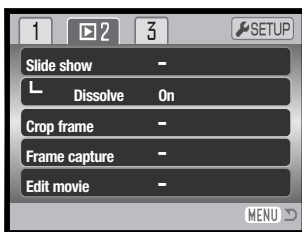
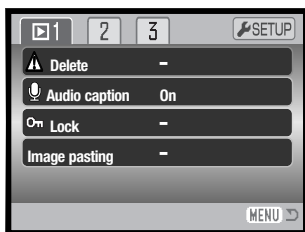

Index to menu functions

Audio caption, 59

Crop frame, 63

Date print, 69

Delete, 58

Dissolve, 62

DPOF setup, 68

Edit movie, 66

E-mail copy, 64

Frame capture, 65

Image pasting, 60

Index print, 69

Lock, 60

Slide show, 62

Frame-selection screen

When a marked-frames setting is chosen on the menu, the frame-selection screen appears. This screen allows multiple image and audio files to be chosen.

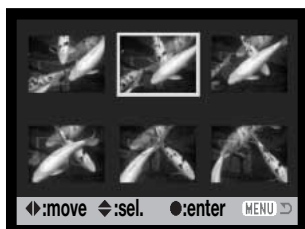

The left/right keys of the controller move the yellow border to select the image.



The up key of the controller selects the frame; when selected, an indicator appears next to the image. The down key deselects the image removing the indicator.



Press the central button of the controller to complete the operation.



MENU The menu button cancels the screen and any operation made.



Indicators may be displayed on the right of each index image to indicate movie, audio, and E-mail copy files.

DELETING IMAGE AND AUDIO FILES



Deleting permanently erases the file. Once deleted, a file cannot be recovered. Care should be taken when deleting images.

Single, multiple, or all files on the memory card can be deleted in section 1 of the playback menu (p. 56). Files must be unlocked before they can be deleted (p. 60). The delete option has four settings:

This frame	The file displayed or highlighted in playback mode is deleted.
Audio track	The voice-memo or audio caption attached to the displayed or highlighted image is deleted.
All frames	All unlocked files are deleted.
Marked frames	To delete multiple files. When this setting is chosen, the frame-selection screen is displayed (p. 57). Use the left/right keys of the controller to highlight the first file to be deleted. Pressing the up key marks the thumbnail with the garbage-can indicator. To deselect a file for deletion, highlight it with the yellow border and press the down key; the garbage-can indicator disappears. Continue until all the files to be deleted are marked. Press the central button of the controller to continue (a confirmation screen appears), or press the menu button to cancel the operation and return to the playback menu.

Before a file is deleted, a confirmation screen appears. Choosing “Yes” executes the operation, “No” cancels it.

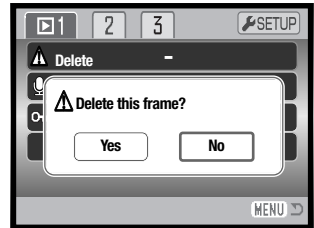

AUDIO CAPTION

A still image can have a fifteen-second audio caption attached to it. This function replaces a voice-memo audio track recorded with an image. Files must be unlocked to use this function (p. 60).

Display the image to which the audio caption will be attached.

On the playback menu, highlight the Enter setting in the audio-caption option. Press the central button of the controller (1) to start recording.

If an audio track is already attached to the image, a confirmation screen appears. Choosing and entering “Yes” starts the audio caption recording replacing the previous audio track. “No” cancels the audio-caption operation.

A status bar and clock display the recording time. The audio caption can be stopped by pressing the central button of the controller (1).

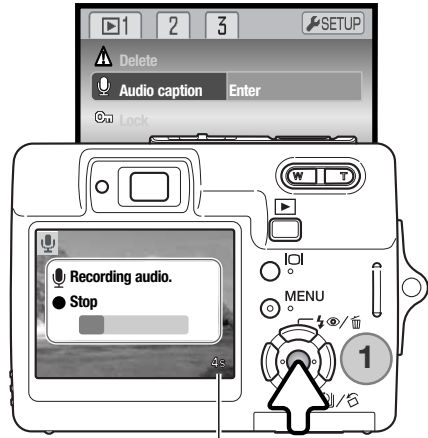

Remaining recording time

LOCKING FILES

Single, multiple, or all files can be locked. A locked file cannot be erased by a delete function. However, the formatting function (p. 72) will erase all files whether locked or not. The lock function is in section 1 of the playback menu (p. 56). The lock option has four settings:

This frame	The file displayed or highlighted in playback mode is locked.
All frames	All files on the memory card are locked.
Marked frames	To lock or unlock multiple files. When this setting is chosen, the frame-selection screen is displayed (p. 57). Use the left/right keys of the controller to highlight the file to be locked. Pressing the up key marks the file with the lock indicator. To unlock a file, highlight it with the yellow border and press the down key; the lock indicator disappears. Continue until all the files to be locked are marked. Press the central button of the controller to lock the files, or press the menu button to cancel the operation.
Unlock all	To unlocked all files.

IMAGE PASTING

Image pasting makes a still image composite by pasting a small image into a background image. The composite image has the same image size and quality as the background image. The lens cover must be open to use this function.



Display the background image on the LCD monitor. Select image pasting in the playback menu and press the center button to start the pasting process.



Nine frame choices are shown on the LCD monitor. Select the frame with the controller. Press the center button to continue.

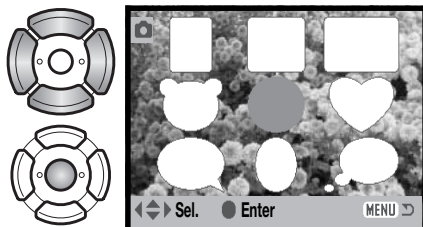

Pressing the menu button at any time during the operation cancels the routine. The camera memorizes any settings entered.

The frame is displayed on the background image. Change the frame size using the up and down keys; three sizes are available. Press the center button to continue.

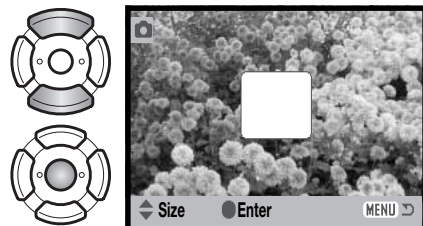

Choose the location for the pasted image by moving the frame with the controller keys. Press the center button to continue.

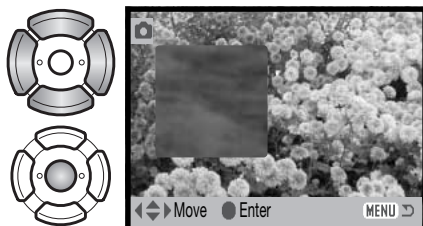

A live image is displayed in the frame. Compose the subject inside the frame and press the shutter-release button partway down to lock the focus. The current recording settings are used to capture the image and the optical zoom can be used. Press the shutter-release button all the way down to take the picture and complete the operation.



SLIDE SHOW

Section 2 of the playback menu controls the slide-show function. This function automatically displays and plays all image, audio, and movie files in order.

To start the slide-show presentation, highlight “Enter” and press the central button of the controller.

During the slide show, pressing the central button of the controller pauses and restarts the presentation.

The left/right keys advance the next still image or return to the previous one. During a movie, the keys forward or rewind the clip.

Press the menu button to cancel the presentation.

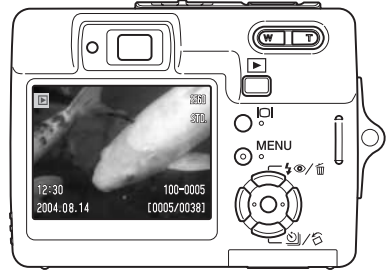
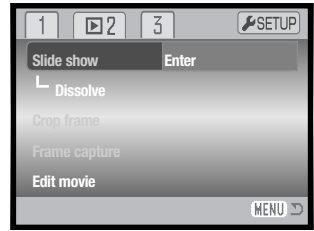
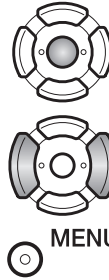

DISSOLVE

The dissolve function randomly selects a dissolve effect for transitions between still images in the slide show. This function can be turned on and off in section 2 of the playback menu (p. 56).

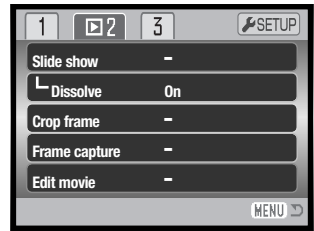

CROP FRAME

A portion of a still image can be copied and saved.

Display the image to be cropped on the LCD monitor. Highlight "Enter" in the crop-frame option in section 2 of the playback menu and press the center button to start the cropping process.

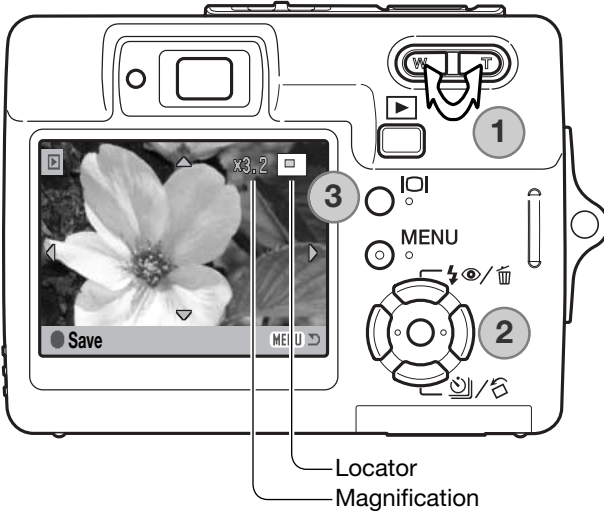
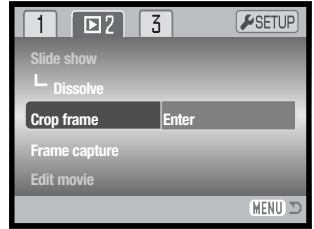

The image displayed on the monitor is the cropped area.

Press the right side of the zoom lever (T) (1) to enlarge the image. Press the left side of the lever (W) to decrease the image size. The degree of magnification is displayed on the LCD monitor.

Use the controller to scroll the image (2).

The locator in the top right corner of the monitor indicates the area of the image being displayed. The display button (3) switches between showing the full display and the image only.



When the image area to be cropped is displayed, press the central button of the controller to save the image data.



The file name of the cropped image is displayed. Press the central button of the controller again to complete the operation.

E-MAIL COPY

E-mail Copy makes a standard 640 X 480 (VGA) JPEG copy of an original still image so that it may be easily transmitted by e-mail. If an economy image is selected for E-mail Copy, the image quality will not change. The copy function is selected in section 3 of the playback-mode menu (p. 56).

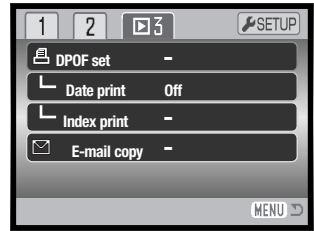

When the copy function is used, a folder is created for the files (p. 84); copy folder name ends in EM. The same folder is used to store e-mail copies until the number of images exceed 9,999. Images with voice memos are copied with their audio files. Copies of locked images are unlocked. DPOF information is not copied.

The amount of data can be converted into E-mail copies depends on the free space remaining on the memory card. The E-mail copy function has two menu options:

This frame	To copy the file displayed or highlighted in the playback mode.
Marked frames	To copy single or multiple files. When selected, the frame-selection screen appears (p. 57); highlight the file to be copied with the yellow border and then press the up key of the controller to mark it. To deselect a file to be copied, highlight the selected thumbnail and press the down key; the indicator disappears. Continue until all the files to be copied are marked. Press the central button of the controller to continue, or press the menu button to cancel the operation and return to the playback menu.

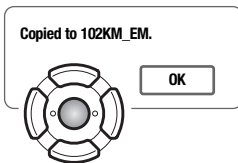

When the image(s) to be converted to an e-mail file are selected, the copy routine begins and a screen appears indicating the name of the folder containing the copied images; press the central button of the controller to return to the menu.

The copy-unsuccessful message appears when one or all of the images could not be copied. Check the memory card to see which files were copied and then repeat the procedure for the uncopied images.

FRAME CAPTURE

The frame-capture option in section 2 of the playback menu allows a single frame from a movie clip can be copied and save as a still image. The copied image has the same image size as the original movie.

The movie from which the frame is to be captured must first be displayed in the playback mode before opening the playback menu. Highlight "Enter" in the frame-capture option and press the center button of the controller to open the capture screen.

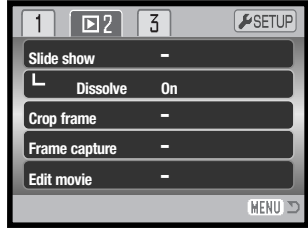

Use the left/right keys of the controller to display the frame to be captured.

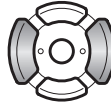

Press the central button of the controller to capture the frame; a confirmation screen appears. Choosing "Yes" executes the operation, "No" cancels it.



The audio from approximately 7.5 seconds before and after the point of the captured frame can be saved. Choosing "Yes" records the movie soundtrack and saves it as an audio-caption WAV file. Selecting "No" records no soundtrack.



When saved, the file names of the captured image and sound track are displayed. Press the center button of the controller to complete the operation.

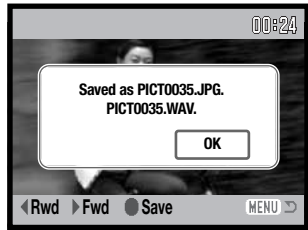

MOVIE EDITING

The edit-movie option in section 2 of the playback menu allows an unwanted section to be cut from a movie clip. The movie to be edited must first be displayed in the playback mode before opening the playback menu. Highlight “Enter” in the movie edit option and press the center button of the controller to open the editing screen.

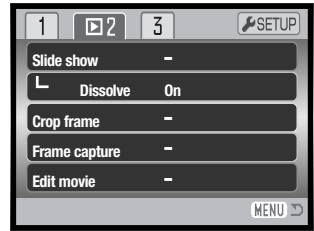

Function menu



The function menu indicates the active step in the editing procedure. The up/down key selects functions.

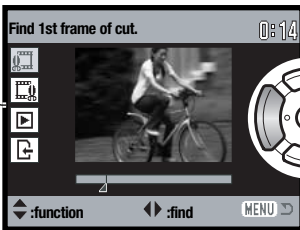

Use the left/right keys of the controller to display the first frame of the section to be cut. The bar under the image and the timer in the top right corner of the screen show the approximate location of the point.

Use the down key to select the next step.

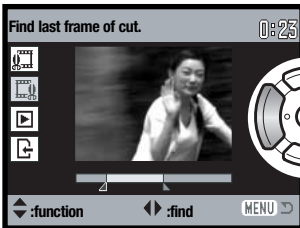

Use the left/right keys of the controller to display the last frame of the section to be cut. The bar under the image and the timer in the top right corner of the screen show the approximate location of the point.

Use the down key to select the next step.

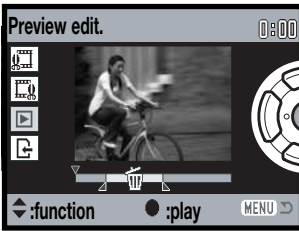

Press the center controller button to preview the edit. The arrow above the bar indicates the playback frame.

After playback, use the down key to continue if the edit is acceptable. To make changes to the edit, use the up key of the controller to return to the previous steps to adjust the start and end points. To cancel the edit operation, press the menu button.

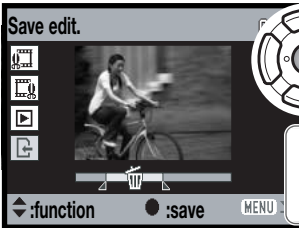

Press the center controller button to save the edit; a confirmation screen is displayed. Select "Yes" to continue.



After the edited movie clip is saved, the file name is displayed.

The original movie file can be deleted from the memory card by selecting "Yes" on the screen. Once deleted, it cannot be recovered. By selecting "No," both the original and edited file remain on the card.

ABOUT DPOF

This camera is supported by DPOF™. The DPOF (Digital Print Order Format) allows direct printing of still images from digital cameras. After the DPOF file is created, the memory card is simply taken to a photofinishing service or inserted into the memory-card slot of DPOF compatible printers. When a DPOF file is created, a misc. folder is automatically created on the memory card to store it (p. 84).

DPOF SETUP

The DPOF-set menu option is used to create an order for standard prints from still images on the memory card. Single, multiple, or all images can be printed. Print orders are created in section 3 of the playback menu (p. 56). The print menu option has four settings:

This frame	To create a DPOF file for the displayed or highlighted image.
All frames	To create a DPOF file for all images on the memory card.
Marked frames	To chose a group of images to be printed or when the number of copies of each image varies. When selected, the frame selection screen appears (p. 57). Use the left/right keys of the controller to highlight an image to be printed. Pressing the up key marks the image. The number indicates the number of copies that will be printed. Pressing the up key increases the number of copies, pressing the down key decreases the number. A maximum of nine copies can be ordered. To deselect an image for printing, press the down key until the number of copies reaches zero and the printer indicator disappears. Continue until all the images to be printed are marked. Press the central button of the controller to create the DPOF file, or press the menu button to cancel the operation and return to the playback menu.
Cancel all	To delete the DPOF file.

When the this-frame or all-frames setting is chosen, a screen appears requesting the number of copies of each image; a maximum of nine copies can be ordered. Use the up/down keys of the controller to set the required number of copies. If the all-frames setting was used to create a print order, any additional images recorded afterwards are not included in the order.

DPOF files created with another camera is canceled. After the pictures have been printed, the DPOF file remains on the memory card and must be canceled manually.

DATE PRINT

To print the date of capture with each image with a DPOF compatible printer, turn the section 3 menu option on. To cancel date print, simply turn the option off. How and where the date is printed varies with the printer.

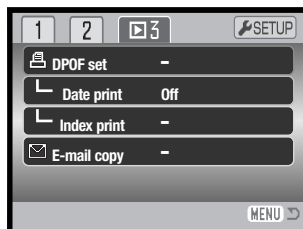

INDEX PRINT

To create an index print of all the images on the card, select “Yes” in the index print option in section 3 of the playback menu. To cancel an index print, simply change the setting to “No.”

If an index-print order is created, any additional images saved afterwards on the card will not be included in the index print. The number of images printed per sheet differs between printers. The information printed with the thumbnails can vary.



Camera Notes

DPOF files and images can be printed directly from the camera with a DPOF compatible PictBridge printer, see pages 90 and 95.

SETUP MODE

The setup menu is used to control the camera's functions and operation. The navigating the setup menu section covers the operation of the menu. The section is followed by detailed descriptions of the settings.

NAVIGATING THE SETUP MENU

The setup menu is opened from the other menus. It can be accessed from any of the recording or playback menus.



Use the right key to highlight the setup tab at the top of the menu.



Press the central button to open the setup menu.

Reverse the procedure to return to the original menu. Pressing the menu button closes the setup menu and returns to the recording or playback modes.

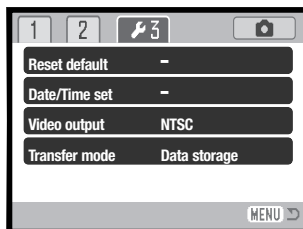
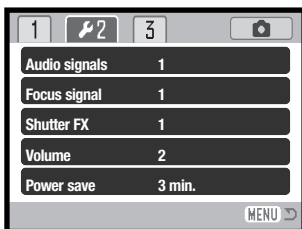
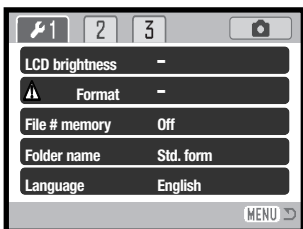

Index to menu functions

Audio signals, 74
Date / Time setup, 77
File # memory, 73
Focus signal, 74
Folder name, 73

Format, 72
Language, 74
LCD brightness, 72
Power save, 75
Reset default, 76

Shutter FX, 75
Transfer mode, 77
Video output, 78
Volume, 75

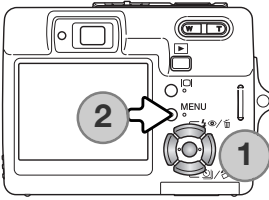

Navigating the menu is simple. The four-way keys of the controller (1) control the cursor and change settings on the menu. Pressing the center button of the controller selects menu options and sets adjustments.



Use the left/right keys of the controller to highlight the appropriate menu tab; the menu changes as the tabs are highlighted.



Use the up/down keys to scroll through the menu options. Highlight the option whose setting needs to be changed.

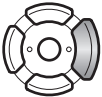

With the menu option highlighted, press the right controller key; the settings are displayed with the current setting highlighted. If “Enter” is displayed, press the center button of the controller to continue.



Use the up/down keys to highlight the new setting.



Press the central button of the controller to select the highlighted setting.

Once a setting has been selected, the cursor returns to the menu options and the new setting is displayed. To close the menu, press the menu button (2).

LCD MONITOR BRIGHTNESS

The brightness of the LCD monitor can be set in eleven levels. The brightness setting screen is opened from section 1 of the setup menu (p. 70).

Use the left/right keys of the controller to adjust the brightness, the monitor image changes accordingly. Press the central button of the controller to set the brightness level.

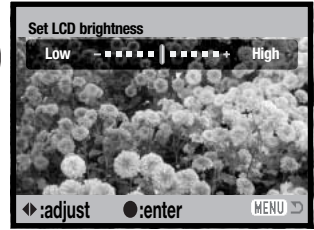
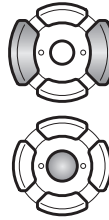

FORMATTING MEMORY CARDS



When a memory card is formatted, all data on the card is erased.

The formatting function is used to erase all data on a memory card. Before formatting a memory card, copy the data to a computer or storage device. Locking images will not protect them from being deleted when the card is formatted. Always format the memory card using the camera; never use a computer to format a card.

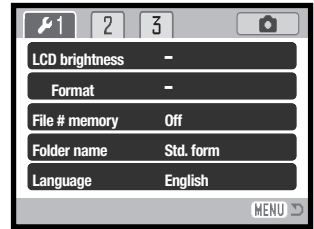

When the format option is selected and entered in section 1 of the setup menu (p. 70), a confirmation screen appears. Choosing “Yes” formats the card, choosing “No” cancels the formatting operation. A message appears to indicate the card has been formatted.

If the unable-to-use-card message appears, the inserted card in the camera may need to be formatted. A memory card used in another camera may also have to be formatted before being used.

FILE NUMBER (#) MEMORY

If file number memory is selected, when a new folder is created, the first file stored in the folder will have a number one greater than the last file saved. If the file number memory is disabled, the image file number will be 0001. File number memory is activated in section 1 of the setup menu (p. 70).

If file number memory is active and the memory card is changed, the first file saved to the new card will have a number one greater than the last file saved on the previous card if the new card does not contain an image with a greater file number. If it does, the file number of the new image will be one greater than the greatest on the card.

FOLDER NAME

All recorded images are stored in folders on the memory card. Folder names come in two formats, standard and date.

Standard folders have an eight character name. The initial folder is named 100KM007. The first three digits are the folder's serial number, which will increase by one each time a new folder is created. The next two letters refer to Konica Minolta, and the last three numbers indicate the camera used; 007 indicates a DiIMAGE X50.



100KM007
(Standard)

A date folder name also starts with the three digit serial number and is followed by one register for the year, two register for the month, and two registers for the day: 101YMMDD. The folder 10140824 was created in 2004 on August 24th.



10140824
(Date)

With the date folder format selected, when an image is recorded a new folder with the day's date will be created. All images recorded that day are placed in that folder. Images recorded on a different day are placed in a new folder with the corresponding date. If the file number memory function is off, when a new folder is created, the serial number in the image-file name is reset to 0001. If file number memory function is on, the serial number in the image-file will be one greater than the last image saved. For more information on folder organization and file names, see page 84.

LANGUAGE

The language used in the menus can be changed. The language is selected in section 1 of the setup menu (p. 70).

Highlight the current menu language in the setup menu and press the center button of the controller to open the language screen.



Use the four-way key of the controller to highlight the new menu language.



Press the central button of the controller to set the language.



AUDIO SIGNALS

Every time a button is pressed, an audio signal gives a positive confirmation of the operation. The audio signals can be turned off in section 2 of the setup menu (p. 70). Two audio signals are available.

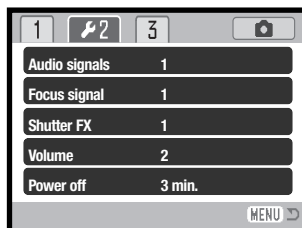

FOCUS SIGNAL

When the shutter-release button is pressed partway down, an audio signal confirms the AF system has focused. The focus signals can be changed or turned off in section 2 of the setup menu (p. 70). Two tones are available.

SHUTTER FX

When the shutter is released, a shutter sound effect will give a positive confirmation of the operation. The sound effect can be turned off in section 2 of the setup menu (p. 70). Two shutter effects are available; signal 1 is mechanical and signal 2 is electrical. The mechanical shutter sound was taken from the legendary Minolta CLE, a compact rangefinder that represents the pinnacle of the development of the Leitz-Minolta CL.



VOLUME

The volume of the audio signals and shutter FX can be increased or decreased in section 2 of the setup menu (p. 70). This affects the camera's audio signals only and will not change the playback levels of an audio track.

AUTO POWER SAVE

To conserve battery power, the camera shuts down if an operation is not made within a certain period. To restore power, press the shutter-release button or playback button. The length of the auto-power-save period can be changed in section 2 of the setup menu (p. 70): 1, 3, 5, 10, and 30 minutes. The length of the auto-power-save period is fixed at 10 minutes when the camera is connected to a computer or PictBridge printer.

RESET DEFAULT

This function affects all modes. When selected, a confirmation screen appears; choosing “Yes” resets the following functions and settings, “No” cancels the operation.

Recording mode		
Focus area	Wide focus frame	p. 31
Monitor display	Full display	p. 29
Exposure compensation	0.0	p. 48
Flash mode	Autoflash	p. 28
Drive mode	Single-frame advance	p. 37
Image size	2560 X 1920	p. 42
Image quality	Standard	p. 42
White balance	Auto	p. 44
Custom key function	Off	p. 45
Metering mode	Multi segment	p. 47
Camera sensitivity (ISO)	Auto	p. 46
Color mode	Color	p. 43
Auto reset	On	p. 45
Voice memo	Off	p. 49
Date imprinting	Off	p. 50
Digital zoom	Off	p. 51
Instant playback	Off	p. 47
Recording mode (Movie menu)	Movie	p. 52
Frame rate	15 fps	p. 53
Movie mode	Standard movie	p. 53
Playback menu		
Dissolve	On	p. 62
Date print	Off	p. 69

Setup menu		
LCD Brightness	Normal	p. 72
File number (#) memory	Off	p. 73
Folder name	Standard	p. 73
Audio signals	1	p. 74
Focus signal	1	p. 74
Shutter FX	1	p. 75
Volume	2	p. 75
Auto-power-save period	3 minute	p. 75
Transfer mode	Data storage	p. 77

DATE AND TIME

The date/time setup screen is opened from section 3 of the setup menu (p. 70). See page 20 for how to set the date and time.

TRANSFER MODE

The transfer mode must be specified depending on how the camera is to be used with a computer or printer. Three transfer-mode options are available:

Data storage	To transfer data between the camera and computer. This option must be selected when moving image files to the computer, or using the camera with the DiIMAGE Viewer software.
Remote camera	To use the live video feed from the camera on a computer.
PictBridge	To print images with a PictBridge compatible printer.

For more on these options, refer to the data-transfer section of the manual.

VIDEO OUTPUT

Camera images can be displayed on a television. The video output can be changed between NTSC and PAL in section 3 of the setup menu. North America uses the NTSC standard and Europe uses the PAL standard. Check which standard is used in your region to play back images on your television set.

VIEWING IMAGES ON A TELEVISION

The supplied AV cable is used to view camera images on your television.

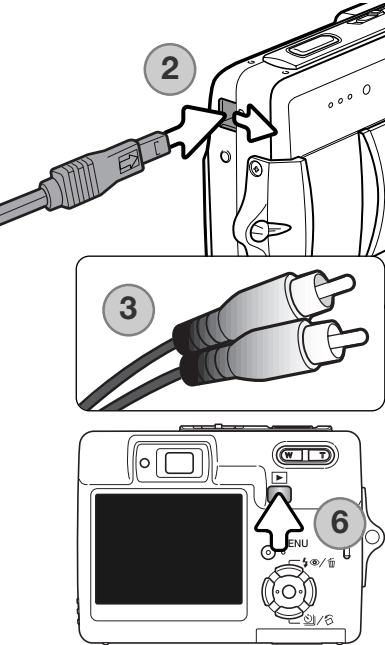

1. Turn off the television and the camera.
2. Slide the terminal cover open. Insert the small plug of the AV cable into the camera's AV-out terminal. The arrow mark on the plug should face the front of the camera.
3. Plug the other end of the AV cable into the video and audio input terminals on the television. The yellow plug is for the video output. The white plug is for the monaural audio output.
4. Turn the television on.
5. Change the television to the video channel.
6. Press and hold the playback button until the playback display is visible on the television screen. The camera's monitors do not activate when the camera is attached to a television.
7. View images as described in the playback section.

DATA-TRANSFER MODE

Read this section carefully before connecting the camera to a computer. Details on using and installing the DiIMAGE Viewer software are found in the supplied software manual. The DiIMAGE manuals do not cover the basic operation of computers or their operating systems; please refer to the manual supplied with your computer.

SYSTEM REQUIREMENTS

For the camera to be connected directly to the computer and used as a mass-storage device, the computer must be equipped with a USB port as a standard interface. The computer and the operating system must be guaranteed by their manufacturers to support USB interface. The following operating systems are compatible with the camera:

Windows 98, 98SE, Me, 2000 Professional, and XP Home and Professional editions.

Mac OS 9.0–9.2.2 and Mac OS X 10.1.3–10.1.5, 10.2.1–10.2.8, 10.3–10.3.3.

Check the Konica Minolta web site for the latest compatibility information:

North America: <http://www.konicaminolta.us/>

Europe: <http://www.konicaminoltasupport.com/>

Users with Windows 98 or 98 Second Edition will need to install the driver software on the included DiIMAGE Viewer CD-ROM (p. 81). No special driver software is required for other Windows or Macintosh operating systems.

Customers who have bought a previous DiIMAGE digital camera and have installed the Windows 98 driver software must repeat the installation procedure. The updated version of the driver software included on the supplied DiIMAGE Viewer CD-ROM is required for the operation of the DiIMAGE X50 with a computer. The new software has no affect on the performance of older DiIMAGE cameras.

CONNECTING THE CAMERA TO A COMPUTER

A fully charged battery should be used when the camera is connected to a computer. The use of the AC adapter (sold separately) is recommended over the use of the battery. For users with Windows 98 or 98SE, read the section on page 81 on how to install the necessary USB driver before connecting the camera to a computer.

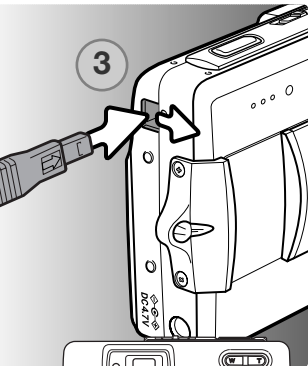

1. Start up the computer. The computer must be turned on before connecting the camera.
2. Insert the memory card into the camera. To change the memory card while the camera is connected to a computer, see page 88.
3. Slide the USB-port cover open. Insert the small plug of the USB cable into the camera. Make sure the plug is firmly attached.
4. Attach the other end of the USB cable to the computer's USB port. Make sure the plug is firmly attached. The camera should be connected directly to the computer's USB port. Attaching the camera to a USB hub may prevent the camera from operating properly.
5. Turn on the camera to initiate the USB connection. While the camera is connected to a computer, the data-transfer screen is displayed.

When the USB connection is completed, a drive icon, or volume, appears in My Computer or the desktop; the name varies with memory card. When using Windows XP or Mac OS X, a window opens requesting instructions on what to do with the image data; follow the directions in the window.

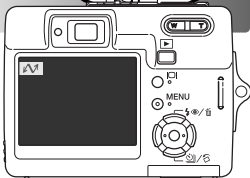

Windows XP

Windows



Mac OS



CONNECTING TO WINDOWS 98 AND 98SE

The driver needs only to be installed once. If the driver cannot be installed automatically, it can be installed manually with the operating system's add-new-hardware wizard; see the instructions on the following page. During installation, if the operating system requests the Windows 98 CD-ROM, insert it into the CD-ROM drive and follow the accompanying instructions on the screen. No special driver software is required for other Windows operating systems.

Automatic Installation

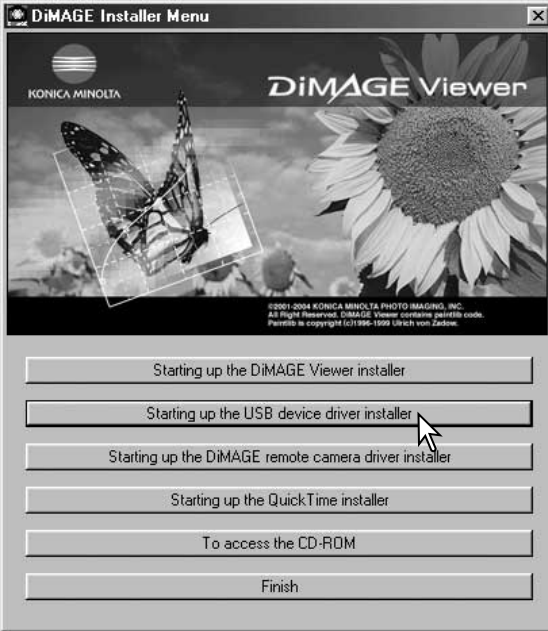

Before connecting the camera to the computer, place the DiIMAGE Viewer CD-ROM in the CD-ROM drive. The DiIMAGE installer menu should automatically activate. To automatically install the Windows 98 USB driver, click on the “Starting up the USB device driver installer” button. A window appears to confirm that the driver should be installed; click “Yes” to continue.



A message appears when the driver has been successfully installed. Click “OK.” Restart the computer before connecting the camera (p. 80).

Manual Installation



To install the Windows 98 driver manually, follow the instructions in the connecting-the-camera-to-a-computer section on page 80.

When the camera is plugged into the computer, the operating system will detect the new device and the add-new-hardware-wizard window opens. Place the DiIMAGE Viewer CD-ROM in the CD-ROM drive. Click “Next.”



Choose the recommended search for a suitable driver. Click “Next.”

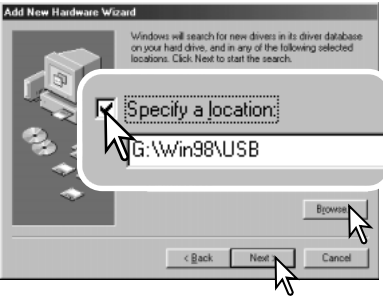

Choose to specify the location of the driver. The browse window can be used to indicate the driver location. The driver should be located in the CD-ROM drive at :\Win98\USB. When the location is shown in the window, click “Next.”



The add new hardware wizard will confirm the location of the driver. The letter designating the CD-ROM drive will vary between computers. Click “Next” to install the driver in the system.

One of three drivers may be located: MNLVENUM.inf, USBPDR.inf, or USBSTRG.inf.



The last window confirms the driver has been installed. Click “Finish” to close the add new hardware wizard. Restart the computer.



When the my-computer window is opened, a new removable-disk icon is displayed. Double click on the icon to access the camera's memory card; see page 84.

MEMORY CARD FOLDER ORGANIZATION



Drive Icon

Once the camera is connected to the computer, image and audio files can be accessed by double clicking on icons. Image folders are located in the DCIM folder. To copying images and audio recordings, simply drag and drop the file icon into a location in the computer.

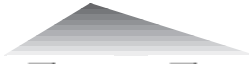

Dcim



Misc

The misc. folder contains DPOF print files (p. 68).

Files and folders on the memory card can be deleted using the computer. Never format the memory card from the computer; always use the camera to format the card. Only files recorded by the camera should be stored on the memory card.



100KM007



1010801



102KM_EM



PICT0001.JPG
Fine, standard,
or economy
image



PICT0001.WAV
PICT0001's
voice-memo or
audio-caption
file



PICT0002.MOV
Movie clip



PICT0003.WAV
Audio recording

Image and audio file names begin with "PICT" followed by a four-digit file number and a jpg, or mov extension. Voice-memo and audio-caption files have a wav extension and the file name corresponds to their image file. Audio recordings also use the wav extension. To copy images, simply drag and drop the file icon into a location in the computer.

E-mail Copy images are placed in a folder ending in "EM." When a new folder is created, the first three digits in the folder name will be one greater than the largest folder number on the card. When the index number in the image file name exceeds 9,999, a new folder is created with a number one greater than the greatest folder number on the memory card: e.g. from 100KM007 to 101KM007.

The number in the image file name may not correspond to the frame number of the image. As images are deleted in the camera, the frame counter will adjust itself to show the number of images on the card and reassign the frame numbers accordingly. The serial numbers used with image files will not change when an image is deleted. When a new image is recorded, it will be assigned a number one greater than the largest serial number in the folder. File serial numbers can be controlled with the file-number-memory function in section 1 of the setup menu (p. 73).

Camera Notes

Image files contain exif tag data. This data includes the time and date the image was recorded as well as the camera settings used. This data can be viewed with the camera or the DiMAGE Viewer software. If a camera image is opened in a image-processing application that does not support Exif tags, and then the image is saved overwriting the original data, the exif tag information is erased. Some Exif compatible applications rewrite the Exif data preventing the DiMAGE Viewer from reading it. When using software other than the DiMAGE Viewer, always make a backup copy of the image files to protect the exif tag data.

To view images correctly on your computer, the monitor's color space may need to be adjusted. Refer to your computer manual on how to calibrate the display to the following requirements: sRGB, with a color temperature of 6500K, and a gamma of 2.2.

AUTO POWER SAVE - DATA-TRANSFER MODE

If the camera does not receive a read or write command within ten minutes, it will shut down to save power. When the camera shuts down, an unsafe-removal-of-device warning may appear on the computer monitor. Click "OK." Neither the camera or computer will be damaged in this operation. Unplug the USB cable and turn off the camera. Remake the USB connection by reattaching the cable and turning the camera on.

DISCONNECTING THE CAMERA FROM A COMPUTER



Never disconnect the camera when the viewfinder lamp is lit - the data or memory card may permanently be damaged.

Windows 98 / 98 Second Edition

Confirm that the access lamp is not lit. Turn the camera off, and then disconnect the USB cable.

Windows XP, 2000 Professional, and Me



To disconnect the camera, click once on the unplug-or-eject-hardware icon located on the task bar. A small window opens indicating the device to be stopped.



Click on the small window to stop the device; the safe-to-remove-hardware window opens. Click on "OK" to close the window, turn the camera off, and then disconnect the USB cable.



When more than one external device are connected to the computer, repeat the procedure above except right click on the unplug-or-eject-hardware icon. This will open the unplug-or-eject-hardware window after clicking on the small window indicating the unplug-or-eject-hardware routine.



The hardware devices to be stopped is displayed. Highlight the device by clicking on it then click “Stop.”

A confirmation screen appears to indicate the devices to be stopped. Clicking “OK” stops the device.

A third and final screen appears to indicate the camera can be safely disconnected from the computer. Close the window, turn the camera off, and then disconnect the USB cable.

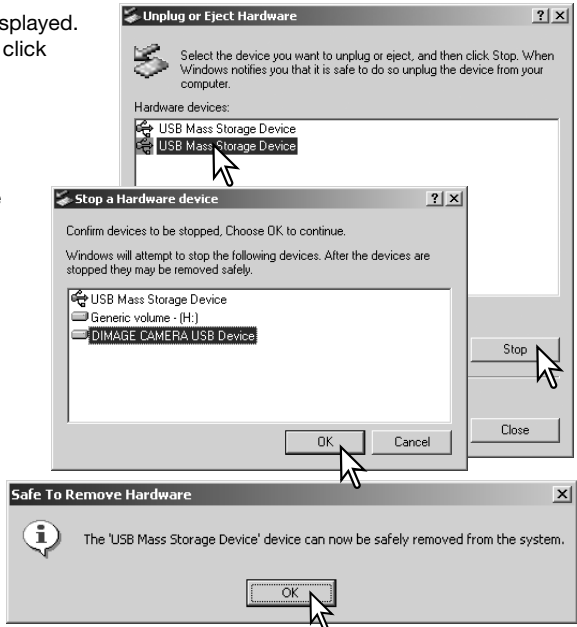

Macintosh

Confirm that the access lamp is not lit and then drag the mass-storage device icon and drop it into the trash. Turn the camera off, and then disconnect the USB cable.



CHANGING THE MEMORY CARD - DATA-TRANSFER MODE



Never remove the card when the viewfinder lamp is lit - the data or memory card may permanently be damaged.

Windows XP, 2000 Professional, and Me

1. Stop the USB connection using the unplug-or-eject-hardware routine (p. 86).
2. Turn off the camera.
3. Change the memory card.
4. Turn on the camera to remake the USB connection.

Windows 98 and 98 Second Edition

1. Turn off the camera.
2. Change the memory card.
3. Turn on the camera to remake the USB connection.

Macintosh

1. Stop the USB connection by dragging the drive icon into the trash (p. 87).
2. Turn off the camera.
3. Change the memory card.
4. Turn on the camera to remake the USB connection.

QUICKTIME SYSTEM REQUIREMENTS

IBM PC / AT Compatible

**Pentium processor-based PC
or compatible computer**

Windows 98, Me, 2000, or XP.

128MB or more of RAM

To install QuickTime, follow the instructions in the installer. Macintosh users can download the latest version of QuickTime free of charge from the Apple Computer web site: <http://www.apple.com>.

REMOVING THE DRIVER SOFTWARE - WINDOWS

1. Insert a memory card in the camera and connect it to the computer with the USB cable. Other devices must not be connected to the computer during this procedure.

2. Right click on the My-computer icon. Select “properties” from the drop-down menu.

Windows XP: from the start menu go to the control panel. Click on the performance and maintenance category. Click “System” to open the system properties window.

3. Windows XP and 2000 Professional: select the hardware tab in the properties window and click the device-manager button.

Windows Me and 98: click the device-manager tab in the properties window.

4. The driver file will be located in the universal-serial-bus-controller or other-devices location of the device manager. Click on the locations to display the files. The driver should be indicated with the camera name. Under certain conditions, the driver name may not contain the camera name. However, the driver will be indicated by either a question mark or exclamation point.

5. Click on the driver to select it.

6. Windows XP and 2000 Professional: click on the action button to display the drop-down menu.

Select “uninstall.” A confirmation screen will appear. Clicking “Yes” will remove the driver from the system.

Windows Me and 98: click the remove button. A confirmation screen will appear. Clicking “Yes” will remove the driver from the system.

7. Disconnect the USB cable and turn off the camera. Restart the computer.

PICTBRIDGE

Confirm the transfer-mode option in section 3 of the setup menu is set to PictBridge. Connect the camera to a PictBridge compatible printer using the camera's USB cable. The larger plug on the cable is connected to the printer. Open the AV out/ USB port cover and insert the smaller plug of the cable into the camera. Turn the camera on; the PictBridge screen is displayed automatically.

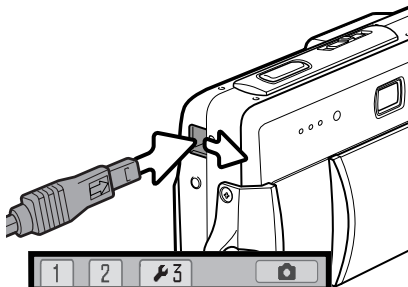

Individual still images can be selected for printing on the PictBridge screen. For other printing options, see the menu navigation section on page 92.

The display button switches between the single frame and index playback formats. Enlarged playback, activated with the zoom lever, can be used to examine image files on the screen.

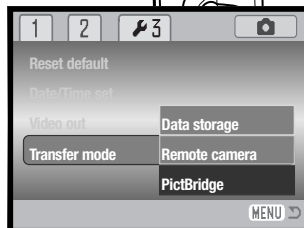

Total number of prints
Number of copies

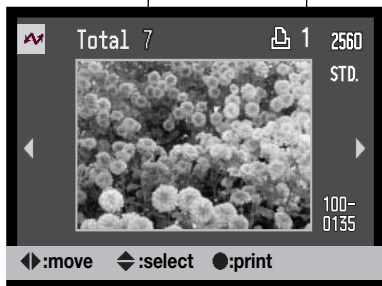

Use the left/right keys of the controller to display the image to be printed.



Press the up key to select the number of copies to be printed. To deselect an image for printing, press the down key until the number of copies reaches zero.



Repeat the previous steps until all the images to be printed are selected. Press the central button of the controller to continue.

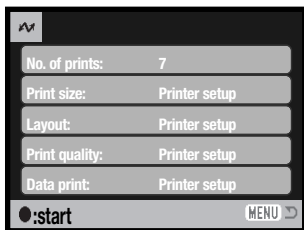

The number of prints in the print run are displayed as well as the print parameters selected with the menu. See the menu navigation section for more information (p. 92). Press the central button of the controller to begin printing, or press the menu button to return to the PictBridge screen.

Once printing begins, the operation can be canceled by pressing the center of the controller. The printing-finished message indicates the end of the operation; turn the camera off to end the routine.

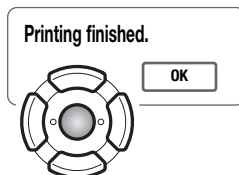

NOTES ON PRINTING ERRORS

If the battery is exhausted before the print run is complete, printing is canceled. Use a fully-charged battery or the optional AC adapter.

If a minor problem occurs during printing, such as the paper runs out, follow the procedure recommended for the printer; no action is required for the camera. If a major printer error occurs, press the center of the controller to end the routine. Refer to the printer manual for the correct procedure for the printer problem. Check the printer settings before starting again and deselect the images that were printed.

NAVIGATING THE PICTBRIDGE MENU

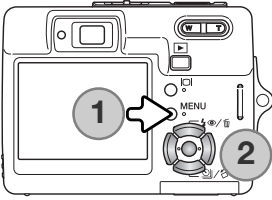

Pressing the menu button (1) turns the menu on and off. The four-way keys of the controller (2) move the cursor in the menu. Pressing the central button of the controller enters a setting. The options that can be changed vary with the printer.

 **MENU** Activate the menu with the menu button.



Use the left/right keys of the controller to highlight the appropriate menu tab; the menu changes as the tabs are highlighted.



Use the up/down keys to scroll through the menu options. Highlight the option whose setting needs to be changed.



With the menu option highlighted, press the right controller key; the settings are displayed with the current setting highlighted. If “Start” or “Enter” is displayed, press the center of the controller to continue.



Use the up/down keys to highlight the new setting.



Press the central button of the controller to select the highlighted setting.

Once a setting has been selected, the cursor returns to the menu options and the new setting is displayed. To return to the PictBridge screen, press the menu button. Read the following sections on information on the menu options.

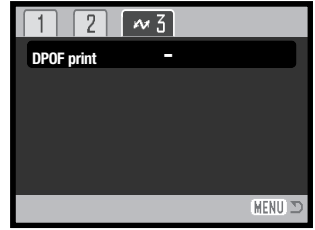
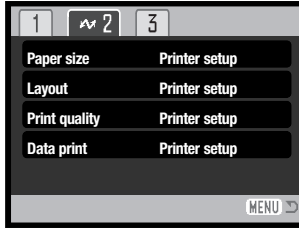
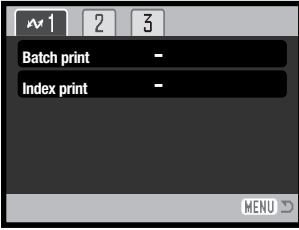

Index to menu functions

Batch print, 93

Data print, 95

DPOF print, 95

Index print, 93

Layout, 94

Paper size, 94

Print quality, 95

Batch print

Batch print in section 1 selects all still images on the memory card for printing. Two options are available:

All-frames - to print all images on the card. A screen opens so the number of copies of each image can be specified. A maximum number of twenty images can be printed.

Reset - to cancel changes made with the batch print option or with the print selection screen.

Index print

An index print of all still images on the memory card can be made. The quality and size of the print can be specified with the camera menu. The number of images per page varies with the printer. The print-setup confirmation screen is displayed before the print routine starts.

Paper size

The paper size of the print can be specified in section 2 of the PictBridge menu. The printer setup option uses the size set with the printer.

Highlight the current size setting in the menu and press the center button of the controller to open the paper-size screen.

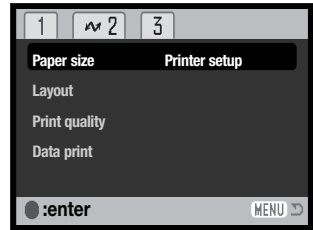

Use the four-way key of the controller to highlight the new paper size.

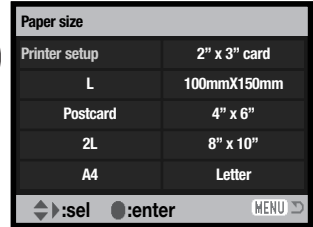
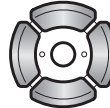

Press the central button of the controller to set the paper size.



Printing Notes

The following are the dimensions for postcard, L, and 2L paper sizes in both millimeters and inches for your reference:

Postcard	100 X 148mm	3.9 X 5.9 in.
L	89 X 127mm	3.5 X 5.0 in.
2L	127 X 178mm	5.0 X 7.0 in.

Layout

The layout of the print can be set in section 2 of the PictBridge menu. The printer-setup option uses the layout parameters of the printer. Borderless printing can be specified with the camera as well as the number of images per page.

Print quality

The print quality can be set in section 2 of the PictBridge menu. The printer-setup option uses the quality set with the printer. The fine quality can be specified with the camera.

Data print

Data can be printed with the image. The printer-setup option uses the options set with the printer. The date of capture and the file name can be selected for printing. Data printing can also be disabled with the menu.

DPOF print

DPOF print in section 3 of the PictBridge menu allows still images and an index print selected with the DPOF printing options in section 3 of the playback menu to be printed from a DPOF compatible PictBridge printer. Simply select the start option from the menu to begin the routine.

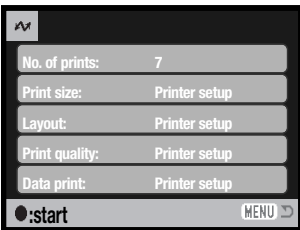

The number of prints in the print run are displayed; an index print is counted as one. Press the central button of the controller to begin printing, or press the menu button to return to the PictBridge menu.

Once printing begins, the operation can be canceled by pressing the center of the controller. The printing-finished message indicates the end of the operation; press the center of the controller and turn the camera off to end the routine.

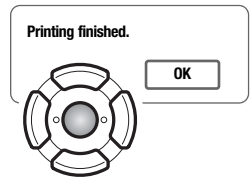

REMOTE CAMERA SYSTEM REQUIREMENTS

For the camera to be connected directly to the computer and used as a remote imaging device, the computer must be equipped with a USB port as a standard interface. The computer and the operating system must be guaranteed by their manufacturers to support USB interface. See chart for system requirements.

The remote-camera driver software must be installed. Specific application software, such as Microsoft Net Meeting, is required to view the images. This function cannot be used with Macintosh computers.

Minimum system requirements

Pentium II 300MHz or later

Windows XP, 2000 Professional, Me, and 98 Second Edition

128MB of RAM. 256MB with Windows XP.

200MB of hard-disk space

800 X 600 16-bit color monitor

Remote camera tested with Microsoft Net Meeting and Windows Messenger

INSTALLING THE REMOTE CAMERA DRIVER

The driver needs only to be installed once. This driver is not compatible with Macintosh operating systems.

Before connecting the camera to the computer, place the DiMAGE Viewer CD-ROM in the CD-ROM drive. The DiMAGE installer menu should automatically activate. To install the driver, click on the “Starting up the DiMAGE remote camera driver installer” button.

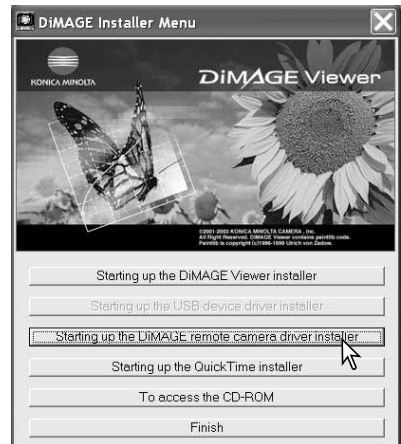



The InstallShield Wizard window is displayed. Click the “Next >” button to continue.

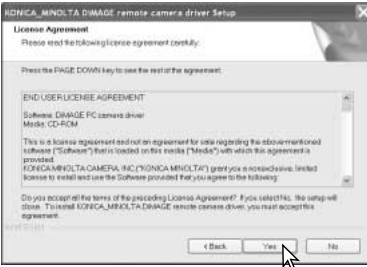

The license agreement is displayed. If you accept the agreement, click the “Yes” button to continue.

Read the entire agreement carefully before continuing. If you do not agree to the terms, click the “No” button to exit the installation program.

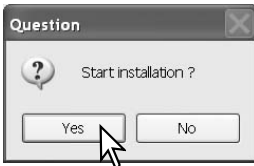

An installation confirmation screen appears. To install the remote camera driver, click “Yes.” The “No” button cancels the operation without installing the driver.



When the driver installation has been completed, a message is displayed. Click the “Finish” button to complete the operation.

CONNECTING THE REMOTE CAMERA

Before the camera can be connected to a computer, the remote camera driver must be installed, see page 96. A fully charged battery should be used when the camera is connected to a computer. The use of the AC adapter set (sold separately) is recommended over the use of the battery. For users with Windows 98SE, the USB driver must be installed before connecting the camera to a computer (p. 81).

1. Select Remote Camera from the transfer mode option in section 3 of the setup menu.
2. Start up the computer. The computer must be turned on before connecting the camera.
3. Slide the USB-port cover open. Insert the small plug of the USB cable into the camera. Make sure the plug is firmly attached.
4. Attach the other end of the USB cable to the computer's USB port. Make sure the plug is firmly attached. The camera should be connected directly to the computer's USB port. Attaching the camera to a USB hub may prevent the camera from operating properly.
5. Turn on the camera to initiate the USB connection. A live image is displayed on the monitor.

To view the live image on the computer, follow the instructions for the application used. Refer to the application's instruction manual or help section for details.

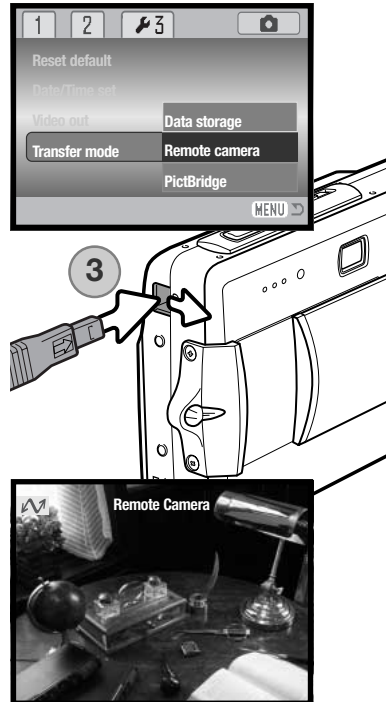

NOTES ON REMOTE CAMERA OPERATION

When using the remote camera, exposure, white balance, and camera sensitivity are set to auto. The optical and 4.3X digital zoom are active. There are no menu controls. The monitor cannot be turned off. The flash is disabled. There is no audio.

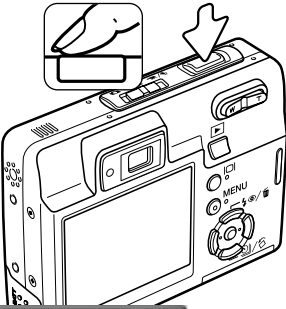

The camera can be focused periodically by pressing the shutter-release button partway down. The AF system does not continually focus when the button is pressed and held so the operation should be repeated as the subject distances changes.

Because of the data rate, there may be delays when the camera is focused or zoomed.

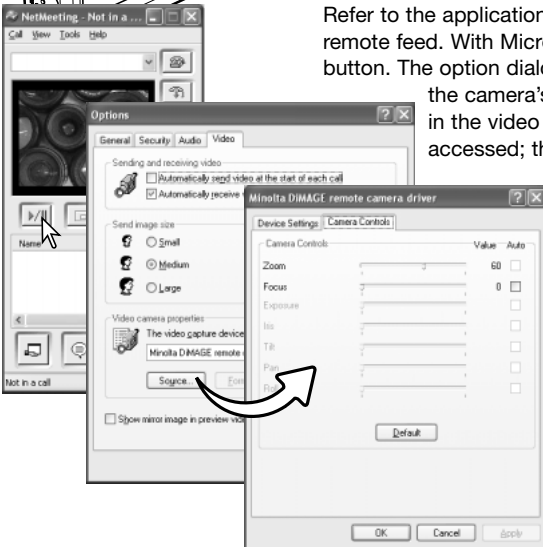

Refer to the applications instruction manual on how to view the remote feed. With Microsoft Net Meeting, simply click on the play button. The option dialog box allows remote control over some of the camera's functions. By clicking on the source button in the video tab, zoom and focus controls can be accessed; the controls are located on the camera control tab of the dialog box. Image magnification can be adjusted with the zoom slider. Clicking the auto check box on the focus option focuses the camera. However, focus is not continuous and the box must be checked each time focusing is required.

APPENDIX

TROUBLESHOOTING

The section covers minor problems with basic camera operation. For major problems or damage, or if a problem continues to reoccur frequently, contact our service facility.

Problem	Symptom	Cause	Solution
The camera will not work.	Nothing displayed on the monitors.	The batteries are dead.	Recharge batteries (p. 14).
		The AC adapter is not connected properly.	Check that the adapter is connected to the camera and a live electrical outlet (p. 17).
Shutter will not release.	Card-full warning appears on the monitor.	Memory card is full and unable to store an image at the image-quality or image-size setting on the camera.	Insert a new memory card (p. 18), delete some images (p. 33), or change the image-quality or image-size setting (p. 42).
	Card-locked warning appears on the monitor.	Memory card is locked.	Unlock the memory card using the write-protect switch (p. 19).
Subject appears too far to the right in the image.	Viewfinder was used for framing. Parallax is apparent with subjects closer than 1m (3ft.) at the zoom's wide-angle position or 3m (10ft) at the telephoto position.		Only use the LCD monitor for framing close subjects.
Part of the image area is hidden behind a dark object.	Viewfinder was used to capture the image.	The lens was partially covered with an object or finger.	When using the viewfinder, take care not to cover the lens.

Pictures are not sharp.	Focus signal is red.	Subject is too close.	Make sure the subject is within the autofocus range (p. 26) or use the macro mode (p. 30).
		A special situation is preventing the autofocus system from focusing (p. 27).	Use the focus-lock function to focus on an object at the same distance as the subject (p. 26).
	Pictures are taken indoors or in low-light situations without flash.	Slow shutter speeds result in blurred images when the camera is hand-held.	Use a tripod, change the camera sensitivity to a higher setting (p. 46), or use the flash (p. 28).
While using flash, the pictures are too dark.	The subject is beyond the flash range (p. 46).		Move closer to the subject or change the camera sensitivity to a higher setting (p. 46).

If the camera does not function normally, turn it off, remove and reinsert the battery, or unplug and reconnect the AC adapter set. Always turn the camera off using the main switch otherwise the memory card may be damaged and camera settings reset.

ABOUT THE LITHIUM-ION BATTERY CHARGER CORD

The included AC cord is designed for the current of the sales region. Only use the cord in the region it was purchased.

Region	Product code
Continental Europe, China, Korea, Singapore (220-240V)	APC-110
Great Britain, Hong Kong (220V-240V)	APC-120
United States, Canada, Taiwan (110V-120V)	APC-130
Japan (100V)	APC-140

CARE AND STORAGE

Read this section in its entirety to get the best results from your camera. With proper care, your camera will provide years of service.

Camera care

- Do not subject the camera to shock or impact.
- Turn off the camera when transporting.
- This camera is neither waterproof nor splashproof. Inserting or removing batteries or the memory card, or operating the camera with wet hands may damage the camera.
- When at the beach or near water, take care not to expose the camera to water or sand. Water, sand, dust, or salt can damage the camera.
- Do not leave the camera under direct sunlight. Do not point the lens directly at the sun; the CCD may be damaged.

Cleaning

- If the camera or the outside of the lens is dirty, gently wipe it with a soft, clean, dry cloth. If the camera or lens comes in contact with sand, gently blow away loose particles. Wiping may scratch the surface.
- To clean the lens surface, first blow away any dust or sand, then gently wipe the lens with a cloth or tissue designed for optics. Use lens-cleaning fluid if necessary.
- Never use organic solvents to clean the camera.
- Never touch the lens surface with your fingers.

Storage

- Store in a cool, dry, well-ventilated area away from dust and chemicals. For long periods of disuse, store the camera in an airtight container with a silica-gel drying agent.
- Remove the batteries and memory card from the camera when not in use for extended periods.
- Do not store the camera in an area with naphthalene or mothballs.
- During long periods of storage, operate the camera occasionally. When taking the camera out of storage, check that the camera is functioning properly before using.

Memory cards

SD Memory Cards and MultiMediaCards are manufactured with precision electronic components.

The following may cause data loss or damage:

- Improper use of the card.
- Bending, dropping, or subjecting the card to impact.
- Heat, moisture, and direct sunlight.
- Static electrical discharge or electromagnetic fields near the card.
- Removing the card or interrupting the power supply while the camera or a computer is accessing the card (reading, writing, formatting, etc.).
- Touching the electrical contacts of the card with your fingers or metal objects.
- Using the card beyond its life. Purchasing a new card periodically may be necessary.

Konica Minolta has no responsibility for any loss or damage to data. It is recommended that a copy of the card data be made.

Batteries

- Battery performance decreases with temperature. In cold environments, we recommend keeping spare batteries in a warm place, such as the inside of a coat. Batteries can recover their power when they warm up.
- Do not store the battery when it is fully charged.
- When storing the battery for extended periods, recharge it for five minutes every six months. The battery may not be able to be charged if completely exhausted.
- Keep battery and camera charger contacts clean. Dirty contacts can prevent charging. If the contacts become dirty, wipe them with a cotton swab.

Before important events and journeys

- Check the camera's operation; take test pictures and purchase spare batteries.
- Konica Minolta has no responsibility for any damage or loss incurred by equipment malfunction.

Operating temperatures and conditions

- This camera has been designed for use in temperatures from 0°C to 40°C (32°F to 104°F).
- Never leave the camera exposed to extreme high temperatures, such as in a car parked in the sun, or to extreme humidity.
- When taking the camera from a cold to a warm environment, place it in a sealed plastic bag to prevent condensation from forming. Allow the camera to come to room temperature before removing it from the bag.

LCD monitor care

- The LCD monitor is manufactured using high-precision technology and more than 99.99% of the pixels operate properly. Less than 0.01% of the monitor pixels are displayed as color or bright points; this is not a monitor defect and does not affect the recorded image.
- Do not apply pressure to the surface of the LCD monitor; it may be permanently damaged.
- In cold temperatures, the LCD monitor may become temporarily dark. When the camera warms up, the display will function normally.
- If fingerprints are on the LCD monitor surface, gently wipe with a soft, clean, dry cloth.

Copyright

- TV program, films, video tapes, photographs, and other materials may be copyrighted. Unauthorized recording or duplication of such material may be contrary to copyright laws. Taking pictures or images of performances, exhibitions, etc., is prohibited without approval and can infringe on copyright. Images protected by copyright can only be used under the provisions within the copyright laws.

Questions and service

- If you have questions about your camera, contact your local camera dealer or write to the Konica Minolta distributor in your area.
- Before shipping your camera for repair, please contact a Konica Minolta service facility.

WHAT IS AN EV?

Ev stands for exposure value. A change of one Ev adjusts the exposure calculated by the camera by a factor of two.

+2.0 Ev	4X as much light
+1.0 Ev	2X as much light
0.0 Ev	Calculated exposure
-1.0 Ev	1/2 as much light
-2.0 Ev	1/4 as much light

TECHNICAL SPECIFICATIONS

Number of effective pixels:	5.0 million
CCD:	1/2.5-type interline primary-color CCD with a total of 5.4 million pixels.
Camera sensitivity (ISO):	Automatic (between ISO 50 - 160 equivalent), ISO 50, 100, 200, 400
Aspect ratio:	4:3
Lens construction:	11 elements in 9 groups.
Maximum aperture:	f/2.8 - f/5.0
Focal length:	6.1 - 17.1 mm (35mm equivalent: 37 - 105 mm)
Focusing range:	0.1m (4 in.) - infinity (from the front of the camera) 0.06m (2.4 in.) - infinity (Super Macro)
Autofocusing system:	Video AF
Shutter:	CCD electronic shutter plus mechanical shutter
Shutter speeds:	4 - 1/1000s
Built-in flash recycling time:	Approximately 6 seconds
Viewfinder:	Optical real-image zoom viewfinder.
Monitor LCD:	5.2 cm (2 inch) digital-interface TFT color
Monitor field of view:	Approximately 100%
A/D conversion:	10 bits
Recording media:	SD Memory Cards and MultiMediaCards
File formats:	JPEG, motion JPEG (MOV), WAV. DCF 1.0, DPOF, and Exif 2.2 compliant.
Print Image Matching II:	Yes
Menu languages:	Japanese, English, German, French, Spanish, and Chinese (Simplified).

Battery:	Konica Minolta NP-700 lithium-ion battery.
Battery performance (recording):	Approximately 150 frames: based on the CIPA (Camera & Imaging Products Association) standard: NP-700 lithium-ion battery, SD memory card included in the product package, LCD monitor on, 2560x1920 image size, standard image quality, no instant playback, no voice memo, flash used with 50% of the frames. Approximately 380 frames: NP-700 lithium-ion battery, SD memory card included in the product package, LCD monitor off, 2560x1920 image size, standard image quality, no instant playback, no voice memo, flash used with 50% of the frames.
Battery performance (playback):	Approximate continuous playback time: 170 min.: NP-700 lithium-ion battery, LCD monitor on, no audio playback.
External power source:	Optional AC-4 or AC-5 adapter
Dimensions:	83.5 (W) X 62.0 (H) X 23.5 (D) mm 3.3 (W) X 2.4 (H) X 0.9 (D) in.
Weight:	Approximately 125g / 4.4oz. (without battery or recording media)
Operating temperature:	0° - 40°C
Operating humidity:	45 - 85% (noncondensing)

Lithium-ion Battery NP-700

Voltage:	3.7V
Weight:	19g / 0.7oz.
Dimensions	15.5 (W) X 15.0 (H) X 47.5 (D) mm 0.6 (W) X 0.6 (H) X 1.9 (D) in.

Battery Charger BC-800

Input voltage:	AC100-240V, 50/60Hz
Weight:	64.5g / 2.3oz.
Dimensions	45.0 (W) X 31.0 (H) X 85.0 (D) mm 1.8 (W) X 1.2 (H) X 3.3 (D) in.

Specifications are based on the latest information available at the time of printing and are subject to change without notice.



KONICA MINOLTA

Konica Minolta Customer Support:
www.konicaminoltasupport.com

Konica Minolta Photo World:
www.konicaminoltaphotoworld.com

Become a member of the Konica Minolta Photo World today.

It is free for registered customers of Konica Minolta

**Werden Sie noch heute Mitglied der Konica Minolta Photo World.
Die Mitgliedschaft ist für registrierte Konica Minolta-Kunden kostenlos!**

**Devenez dès aujourd'hui, membre du Konica Minolta Photo World.
L'inscription est gratuite.**

KONICA MINOLTA PHOTO IMAGING, INC.

© 2004 Konica Minolta Photo Imaging, Inc. under the Berne Convention
and the Universal Copyright Convention.

0-43325-53386-0

9222-2734-11 P-A405/0406/109678
Printed in Japan