

MINOLTA

**MAXXUM<sup>®</sup>**  
**DYNAX<sup>™</sup>**

***5xi***

**E INSTRUCTION MANUAL**

## INTRODUCTION

Congratulations on owning a highly innovative Minolta autofocus SLR.

This instruction manual is designed to help you get the most enjoyment and use out of your camera and is in sections for easy reading and quick reference. Also, it includes a glossary in the back that provides simplified definitions of common photographic terms. First, look over the parts diagrams and familiarize yourself with the controls, their names, and their locations. This will be helpful later when they are introduced in the manual and you learn about their functions. Next, read Preparations, attach the strap, insert the battery, etc.

After you are familiar with the controls and used to holding the camera, read Simple Operation, then you should be ready to use the 5xi in the simplest way possible. As you use the camera, you will begin to realize the power of features such as:

- Expert Flash System
- Predictive Focus Control
- Expert Program Selection with fuzzy logic control
- Creative Program Control

When you are ready for advanced control of the 5xi, Operations in Detail and the Appendix will help you to increase your knowledge to master this unique camera, and expand your control over the medium of photography. After reading this manual, if you need a reminder of how to perform a general camera operation, please refer to the Quick Reference Guide located in the back.

Throughout this instruction manual, certain parts and features will have two names, the first for Dynax and the second for Maxxum. Maxxum is the name of Minolta SLR cameras in North America and Dynax in all other countries except Japan.

## **IMPORTANT INFORMATION**

The Minolta 5xi was designed to work specifically with lenses, flash units, and other accessories manufactured and distributed by Minolta. We therefore caution users of this camera that the attachment and/or use of incompatible products with the 5xi may result in unsatisfactory performance or damage to the camera or its accessories. To obtain *optimum performance throughout the life of your 5xi*, we recommend that you use only those lenses, flashes and other accessories distributed by Minolta specifically for use with this camera.

## **STATEMENT OF FCC COMPLIANCE**

This device complies with Part 15 of the FCC Rules. Operation is subject to the following conditions: (1) This device may not cause harmful interference, and (2) this device must accept any interference received, including interference that may cause undesired operation. Changes or modifications not approved by the party responsible for compliance could void the user's authority to operate the equipment. This equipment has been tested and found to comply with the limits for a Class B digital device, pursuant to Part 15 of the FCC Rules. These limits are designed to provide *reasonable protection against harmful interference in a residential installation*. This equipment generates, uses and can radiate radio frequency energy and, if not installed and used in accordance with the instructions, may cause harmful interference to radio communications. However, there is no guarantee that interference will not occur in a particular installation. If this equipment does cause harmful interference to radio or television reception, which can be determined by turning the equipment off and on, the user is encouraged to try to correct the interference by one or more of the following measures:

Reorient or relocate the receiving antenna.

Increase the separation between the equipment and receiver.

Connect the equipment into an outlet on a circuit different from that to which the receiver is connected. Consult the dealer or an experienced radio/TV technician for help.

## **STATEMENT OF DOC COMPLIANCE**

This digital apparatus does not exceed the Class B limits for radio noise emissions from digital apparatus as set out in the Radio Interference Regulations of the Canadian Department of Communications.

# TABLE OF CONTENTS

## NAMES OF PARTS AND DISPLAYS

Body .....	6
Body Data Panel .....	9
Viewfinder Screen and Viewfinder Data Panel .....	10

## PREPARATIONS

<b>Preliminary</b> .....	12
Neckstrap .....	12
Eyepiece and accessory shoe cap .....	12
<b>Battery</b> .....	13
Inserting .....	13
Battery-condition indicators .....	14
Battery performance .....	15
Cold-weather operation .....	15

## SIMPLE OPERATION

<b>Main Switch/Eye-Start</b> .....	22
<b>Holding the Camera</b> .....	23
Camera-shake warning .....	23
<b>Taking Pictures</b> .....	24
Focus signals .....	25
<b>Focus Lock</b> .....	26

<b>Lens</b> .....	16
Attaching .....	16
Removing .....	17
Care of glass surfaces .....	17
<b>Film</b> .....	18
Loading film .....	18
Automatic film speed setting .....	20
Automatic rewind .....	20
Manual start of rewind .....	20

<b>Programmed Autoexposure (P)</b> .....	27
<b>Flash Basics</b> .....	28
Auto-switchover flash (P mode) .....	28
Viewfinder signals .....	29
Pre-flash .....	30

## OPERATIONS IN DETAIL

<b>Focusing Details</b> .....	32
Autofocus illuminator .....	32
Special focusing situations .....	33
Manual focus .....	34
<b>Exposure Details</b> .....	35
PA/Ps: Creative program control .....	35
Changing exposure mode .....	36
A:Aperture priority .....	37
S:Shutter priority .....	38
M:Manual exposure .....	39
Bulb: Long exposures .....	40
Spot metering .....	42
Exposure compensation .....	44

## APPENDIX

<b>Lens Aperture and Depth of Field</b> .....	58
<b>Shutter Speed and Moving Subjects</b> .....	60
<b>Accessory Information</b> .....	61
Creative expansion cards .....	61
Lens .....	63
Flash .....	63

<b>Self-timer</b> .....	45
<b>Flash Details</b> .....	46
Manual fill-flash (P mode) .....	46
Flash cancel (P mode) .....	46
A, S, and M mode flash .....	47
Flash range .....	47
Slow-shutter sync. flash .....	48
Remote/Wireless off-camera flash control .....	49
Remote/Wireless slow-shutter sync. ....	52
Ratio control .....	52
<b>Film Drive</b> .....	53
<b>Autozoom System</b> .....	54
Auto stand-by zoom .....	54
Image-size lock .....	55

<b>Care and Storage</b> .....	64
<b>Troubleshooting</b> .....	66
<b>Technical Details</b> .....	69
<b>Glossary</b> .....	72
<b>Quick Reference Guide</b> .....	74

## NAMES OF PARTS AND DISPLAYS

### Body

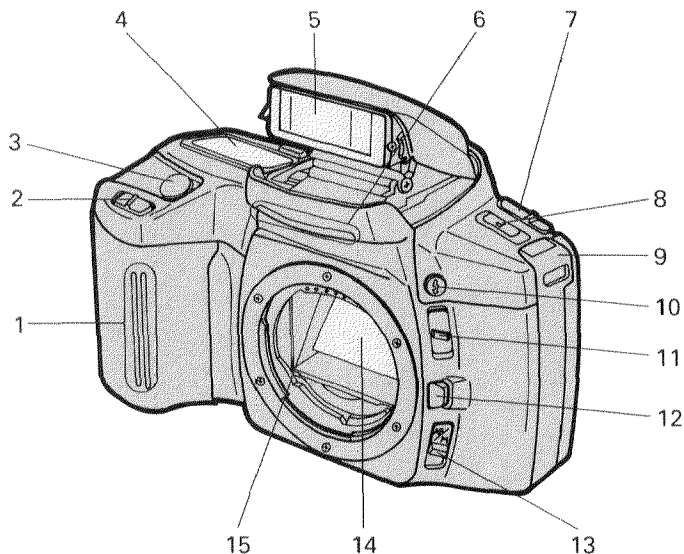

\* Do not touch

- |                                |                              |
|--------------------------------|------------------------------|
| 1. Grip sensor                 | 9. Strap eyelet              |
| 2. Shutter-setting control     | 10. Flash-control button     |
| 3. Shutter-release button      | 11. Aperture-setting control |
| 4. Body data panel             | 12. Lens release             |
| 5. Flash                       | 13. Focus-mode switch        |
| 6. Self-timer-indicator window | 14. Mirror*                  |
| 7. Main switch                 | 15. Lens contacts*           |
| 8. Program-reset button        |                              |



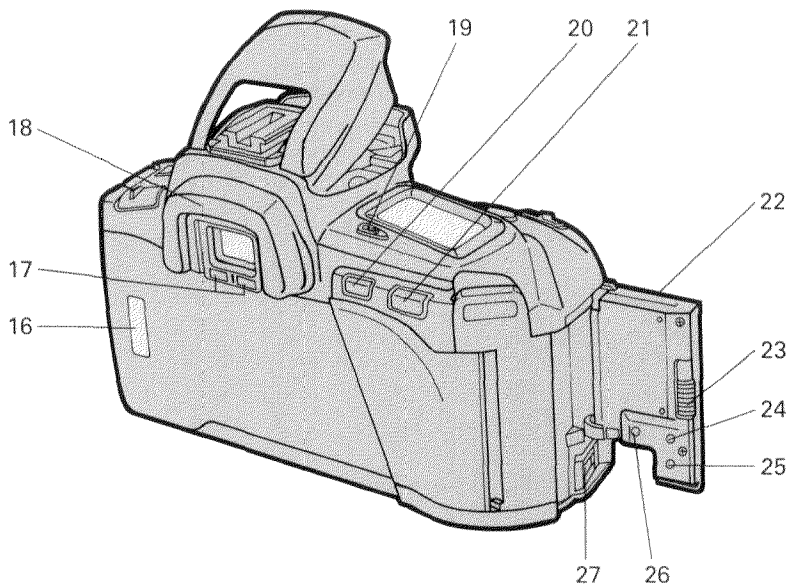

- 16. Film window
- 17. Eyepiece sensor\*
- 18. Eyepiece cup
- 19. Card-on/off button
- 20. Spot-metering button
- 21. Function button

- 22. Card door
- 23. Card-eject slide
- 24. Self-timer/Drive-mode button
- 25. Pre-flash button
- 26. Card-adjust button
- 27. Remote-control terminal

## (Name of parts and displays)

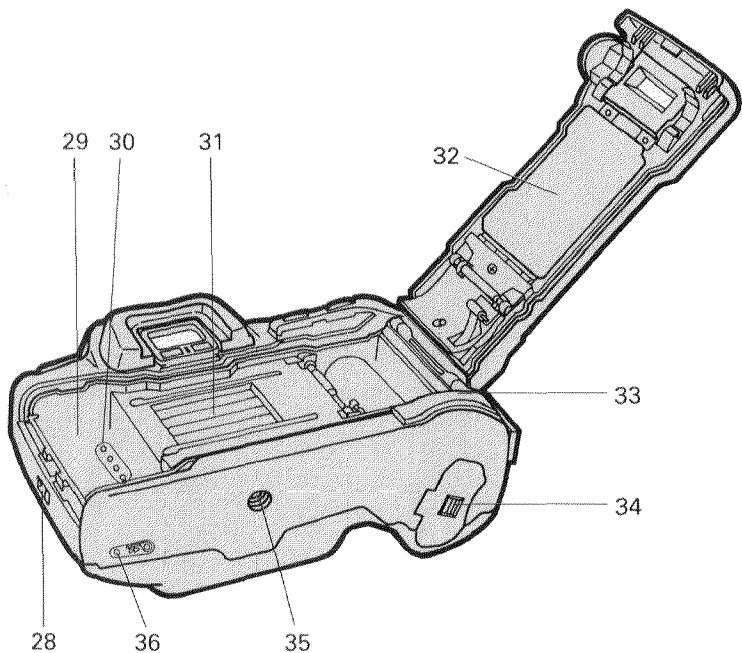

28. Back-cover release

29. Film chamber

30. DX contacts\*

31. Shutter\*

32. Pressure plate\*

33. Film-leader index

34. Battery-cover release

35. Tripod socket

36. Rewind button

## Body Data Panel

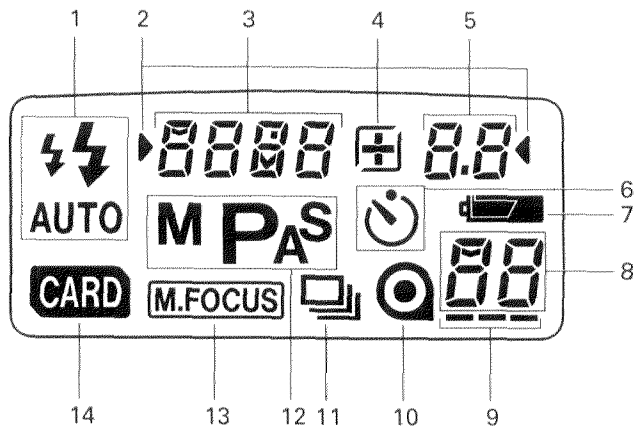

1. Flash-mode indicator
2. Selectable-setting pointers
3. Shutter-speed/Card-name display
4. Exposure-adjustment indicator
5. Aperture/Exposure-adjustment/Card-setting display
6. Self-timer indicator
7. Battery-condition indicator
8. Frame counter/Card-setting display
9. Film-transport signals
10. Film-cartridge mark
11. Drive-mode indicator
12. Exposure-mode indicator
13. Manual-focus indicator
14. Card indicator

## (Name of parts and displays)

### Viewfinder Screen and Viewfinder Data Panel

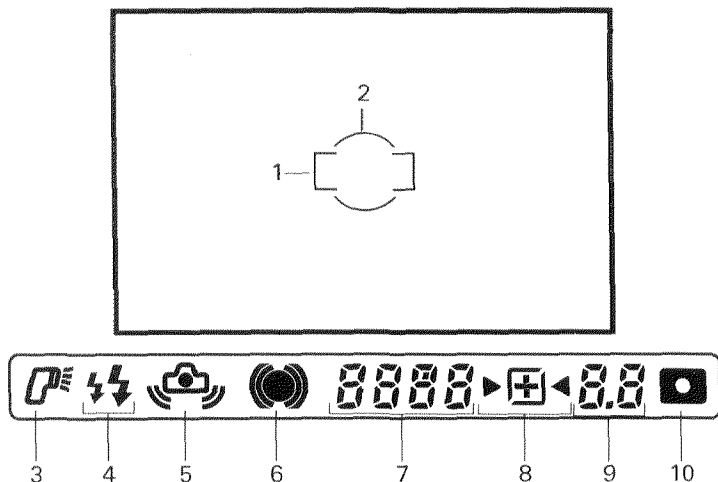

1. Focus frame
2. Spot-metering frame
3. Flash-on indicator
4. Flash-ready indicator
5. Camera-shake warning
6. Focus signal
7. Shutter-speed display
8. Exposure signals/Exposure-adjustment indicator
9. Aperture/Exposure-adjustment display
10. Spot-metering/Slow-shutter-sync. indicator

# PREPARATIONS

This section includes those things which you should do and understand before you use your camera. Read it thoroughly before you go on to **SIMPLE OPERATION** or **OPERATIONS IN DETAIL**.

## PRELIMINARY

### Neckstrap

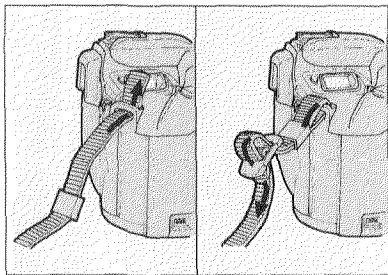

A neckstrap is supplied with your camera. Attach it as shown.

### Eyepiece and accessory shoe cap

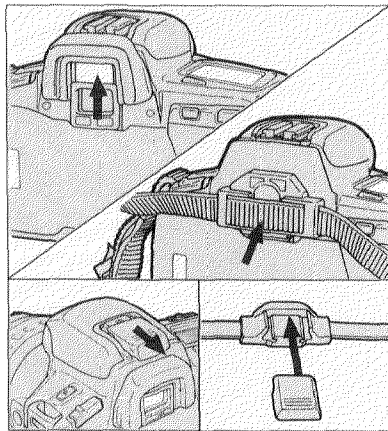

An eyepiece cap is included on the strap. During situations such as self-timer photographs or bulb exposures in which you are not looking through the viewfinder when the shutter releases, remove the eyepiece cup and fit the cap over the eyepiece. This will prevent stray light from entering the camera and affecting the exposure.

The camera also comes with an accessory shoe cap which protects the accessory-shoe contacts. When you are using a flash or other accessory, slide the accessory shoe cap into the eyepiece cap for safekeeping.

# BATTERY

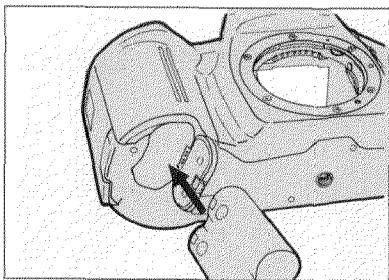
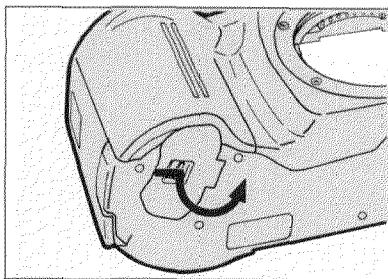

This camera uses a 6-volt 2CR5 lithium battery to supply power to all of its operations. If you are also using an xi-Series lens, the camera battery also supplies power to the zoom motor built into the lens.

## Inserting

1. Slide the main switch to **LOCK** and slide the battery-cover release in the direction indicated to open the battery cover.
2. Insert the battery according to the marks on the inside of the chamber cover.
3. Snap the cover closed.

## CAUTION

- Read and follow all warnings and instructions supplied by the battery manufacturer.
- Do not attempt to disassemble, recharge, or short-circuit the battery. Do not subject it to high temperatures or fire. The battery may explode and cause severe burns.
- Keep batteries away from small children.

## (Battery)

### Battery-condition indicators

When you slide the main switch from **LOCK** to **ON**, one of the following indicators will appear in the data panel.

#### Display



#### Indication

1. Full-battery symbol appears for 4 sec. after you turn camera on.

#### Meaning

Power is sufficient.



2. Low-battery symbol appears for 4 sec. after you turn camera on.

Power is sufficient, but getting low. Keep a fresh battery handy.



3. Low-battery symbol blinks while it appears with other operating indicators at any time during use.

Camera can be operated, but power is extremely low. The battery will need to be changed soon.



4. Low-battery symbol and "bAtte" appears, or no display appears at all, and shutter locks.

Power is insufficient for operation. Replace battery or check that the battery is inserted correctly.

- Indicator 4 will appear even while the main switch is set to **LOCK**.
- If no display appears when the main switch is **ON**, double-check that the battery is inserted correctly before inserting a fresh one.



## **Battery performance**

The 6-volt 2CR5 lithium battery should provide sufficient power for shooting up to 55 rolls of 24-exposure film without flash, 20 rolls of 24-exposure with flash used 50% of the time. These figures are based on Minolta's standard test method using a fresh battery at 20°C (68°F). Actual performance will depend on how you use the camera. If you install a new battery that has been in prolonged storage, the camera's performance may vary.

## **Cold-weather operation**

Lithium batteries perform well in cold weather. However, if you plan to shoot many rolls of film outdoors at temperatures near or below 0°C (32°F), we recommend that you carry the camera inside your coat to keep it warm while you are not shooting. You may also want to carry a spare battery in your pocket so that you can change the camera battery if necessary. Do not discard a cold battery. After it warms up, it will regain some of its charge.

# LENS

## Attaching

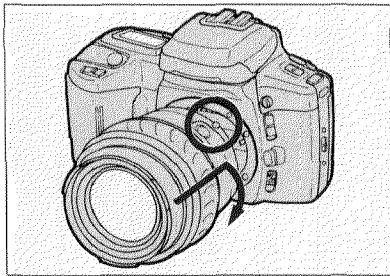
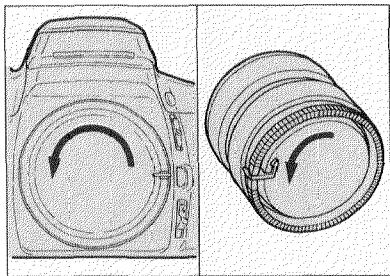

1. Remove the body cap and rear lens cap.
2. Align the red bead on the lens barrel with the red dot on the camera's lens mount. Fit the lens into the mount and turn the lens clockwise until it locks in place with a click.

### Be careful...

- Do not force the lens if it does not turn smoothly.
- Never touch anything inside the camera, especially the lens contacts and mirror.

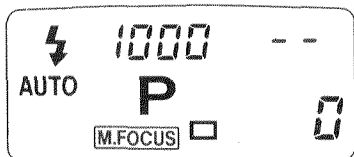

"--" will appear in the aperture display of the data panel if:

- No lens is attached to the camera
- The lens is not attached properly
- The AZ/MZ switch on an xi-Series lens is set to **MZ**

## Removing

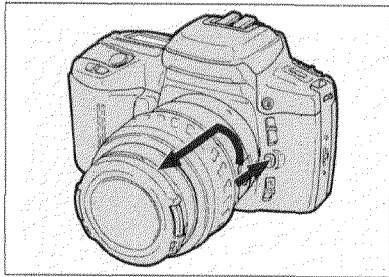

1. Press and hold the lens release while turning the lens counter-clockwise until it stops. Lift the lens out of the mount.
2. Immediately attach the rear cap to the lens and the body cap or another lens to the camera. This will protect the lens elements, lens contacts, and camera interior.

### Care of Glass Surfaces

- Never touch any lens surfaces (including the eyepiece) with your fingers. If a lens becomes dirty, first gently clean it with a lens brush. Then, if necessary, moisten a sheet of lens tissue with one drop of lens-cleaning fluid and, starting from the center of the lens, wipe the glass using a circular motion.
- Never lift the mirror or touch its surface. This may impair its alignment or scratch its face. Dust on the mirror's surface will not affect meter readings or picture quality. If it is distracting, have the camera cleaned at an authorized Minolta service facility.

## Loading film

Before you load a roll of film, always check the body data panel. If the film-cartridge mark is displayed, **do not open the back cover**. Check the film window and frame counter to verify the type of film in the camera and the number of frames remaining. (See p.20 for instructions on rewinding an unfinished roll of film.)

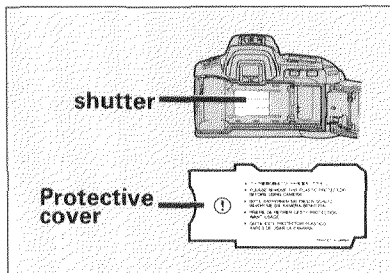

- Before you load film for the first time, carefully remove and discard the protective paper cover over the shutter.

- Always load film in subdued light or shade.

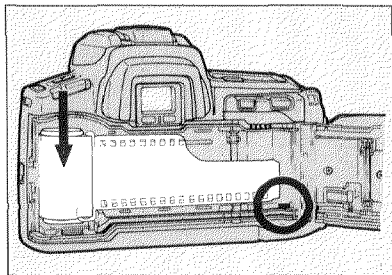
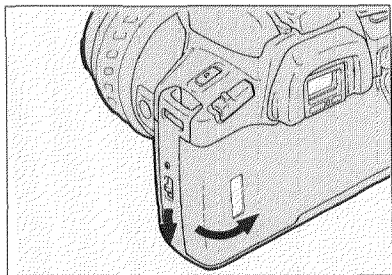

1. Open the back cover by sliding the back-cover release downward.
2. Place the film cartridge into the film chamber and extend the leader between the guide rails until the tip is just past the film-leader index.

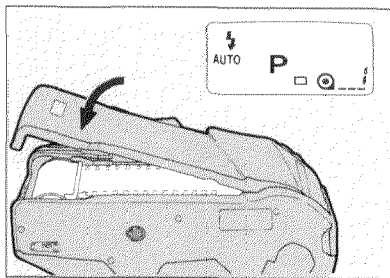

3. Close the back cover and slide the main switch to **ON**. The camera will automatically advance the film to the first frame and **1** will appear in the frame counter.

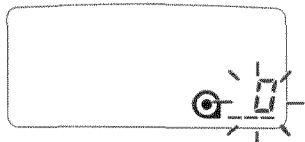

- If the film is loaded incorrectly, **0** will blink in the frame counter and the shutter will remain locked. Open the back cover and repeat steps 2 and 3.

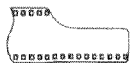

RIGHT

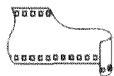

WRONG

- If the film leader is torn or crimped, it may not wind properly.

- If the film tip extends beyond the mark, gently push the excess back into the cartridge.

- If you slide the main switch to **ON** before you load film, do not touch the grip sensor during the above procedures because ASZ may activate.

**Be careful...**

**NEVER TOUCH THE SHUTTER.** Its precision design makes it extremely sensitive to pressure.

## (Film)

### Automatic film speed setting



If you use DX-coded film between ISO 25 and 5000, the camera will automatically set the correct film speed. For flash photography, Minolta recommends that you use film between ISO 25 and 1000. If you use non-DX-coded film, ISO 100 will be automatically selected by the camera.

### Automatic rewind



After you have exposed the last frame, the camera will automatically rewind the film. With a fresh battery, it takes about 18 sec. to rewind a 36-exposure roll, or 12 sec. for a 24-exposure roll.

When the film has been completely rewound, the motor will stop and the film-cartridge mark in the data panel will blink to indicate that it is safe to open the camera back.

### Manual start of rewind

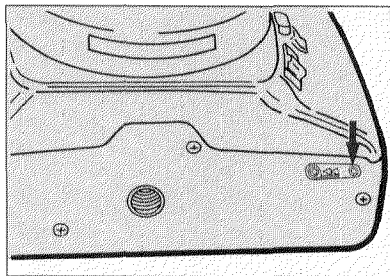

To begin rewind at any time, use a ball point pen or similar object to press the rewind button on the bottom of the camera body.

- If the motor stops before the film is completely rewound, insert a fresh battery.

# **SIMPLE OPERATION**

This brief section is intended to help you get started using your new camera. It explains the simplest method of operation—with programmed autoexposure, autofocus, and auto-switchover flash. Details on each of the camera's functions begins on p.31 in the section entitled "Operation in Detail".

## MAIN SWITCH/EYE-START

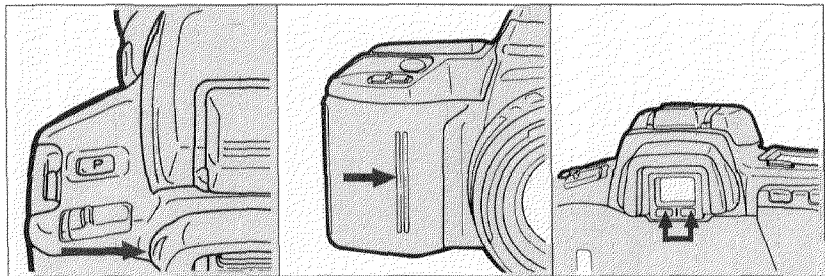

When you slide the main switch to ON, the data panel and grip sensor activate. When you then touch the grip sensor, the eyepiece sensor is activated. This sensor then immediately activates autofocus, autoexposure, and auto-switchover flash when it detects an object near the viewfinder. If you are using an xi-Series Autozoom lens, auto stand-by zoom (ASZ) is also activated by Eye-Start and the lens will zoom automatically. By the time you frame your subject, therefore, the camera has performed many of its set-up operations and is ready to make an exposure. The eyepiece sensor also turns autofocus and autoexposure off when it no longer detects an object near the viewfinder; the last exposure setting will remain in the body data panel for four seconds.

- If you do not touch the grip sensor or if you are wearing gloves, you must activate autofocus and autoexposure by pressing the shutter-release button partway down. ASZ will not function in this case.
- If you are wearing sunglasses which absorb infrared light, Eye-Start may not function.



## HOLDING THE CAMERA

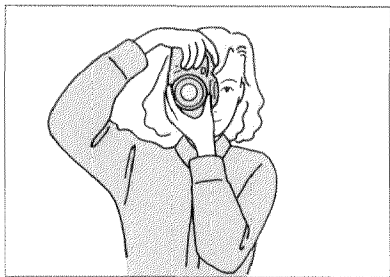
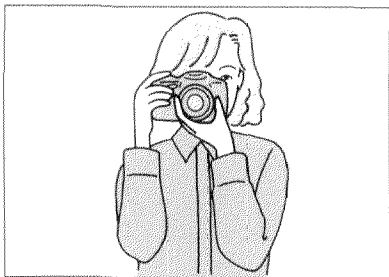

Hold the grip firmly in your right hand and use your left hand to support the camera or lens. Keep your elbows securely against your sides when shooting both horizontal and vertical pictures. Press the shutter-release button gently in a single, steady motion—never with a quick jab. Always keep the camera strap around your neck or wound around one wrist.

- When you pick up the camera, make sure you touch the grip sensor. Otherwise, Eye-Start will not function.
- Do not touch the focusing ring of an AF lens or the end of the lens barrel of an xi-series autozoom lens.

### Camera-shake warning



When your subject or scene is too dark to allow a clear hand-held photograph, the camera-shake warning will blink in the viewfinder data panel. You should either raise the built-in flash by pushing the flash-control button or consider using a tripod.

- In S and M mode, the camera-shake warning will not function.

## TAKING PICTURES

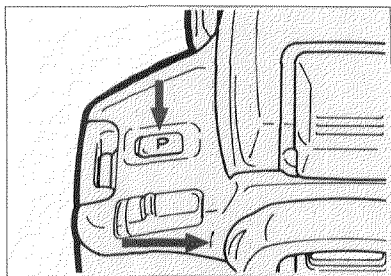



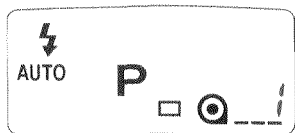

1. Slide the main switch to **ON**.
2. Press the program-reset button to set full-automatic operation.
  - Pressing the program-reset button sets the camera to programmed autoexposure mode, autofocus, and auto-switchover flash. It also resets exposure compensation and self-timer.
3. Hold the camera as described on p.23.
4. Place your main subject in the focus frame and press the shutter-release button all the way down to take the picture.



After the exposure has been made, the camera will automatically advance the film to the next frame and will increase the film counter by one.

## Focus signals



When the camera is activated, either by Eye-Start or by pressing the shutter-release button partway down, the AF system immediately begins measuring subject distance to ensure a sharply focused image. One of the following focus signals will be displayed in the viewfinder data panel:

Signal	Meaning
	Focusing
	Continuous AF mode: focus is confirmed
	Focus is locked (see p.26)
 [blinking]	Focus cannot be confirmed

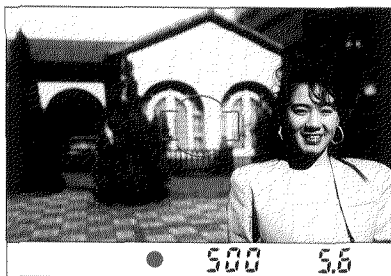
- This camera has Predictive AF. When you take a picture in continuous AF mode, the camera will calculate where the main subject will be when the shutter actually begins to make the exposure, and it will set the lens to focus on this point before the mirror swings up. Extremely fast-moving subjects or subjects which are rapidly changing speed or direction, however, may exceed the capabilities of this system.



If, as a result of the composition or framing you have chosen, the main subject falls outside the focus frame, first lock focus on your subject, then recompose the scene as desired.

1. Place your subject in the focus frame.
  2. Press the shutter-release button partway down.
  3. Make sure you wait for the focus signal to change from  to , then recompose the picture, and press the shutter-release button all the way down to take the picture.
- Focus lock will not work if your subject is moving.
  - Exposure will also lock when shutter-release button is pressed partway down.

## Focus lock with the lens control ring:

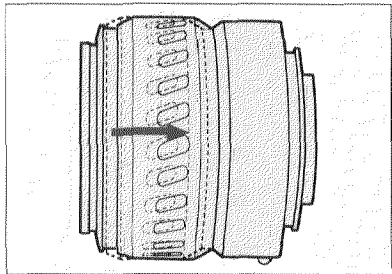

If you are using an xi-Series or power zoom lens, you can lock focus by pulling the lens control ring towards the camera. Hold it in this position while you recompose and take the picture. Do not turn the ring after you lock focus.

## PROGRAMMED AUTOEXPOSURE (P)



P mode is designed to be the camera's primary exposure mode and is ideally suited for almost all situations. Expert Program Selection analyzes the scene, taking into account motion and magnification as well as lens focal length, and sets both the shutter speed and aperture accordingly. It is able to recognize many different photographic situations, landscapes, close-ups, portraits and action shots, and will optimize the exposure settings based on the particular requirements of the situation at hand.

- If the aperture and shutter speed displays blink in the viewfinder and body data panels, then the required exposure settings are beyond the range of the camera and lens.
- If the metering indicators ▶ ◀ blink in the viewfinder data panel, the lighting is beyond the range of available apertures and shutter speeds.

### Auto-switchover flash (P mode)

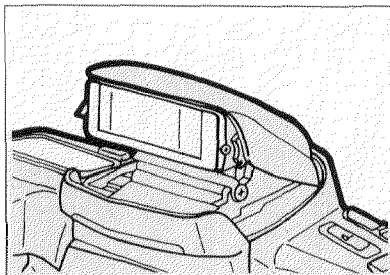
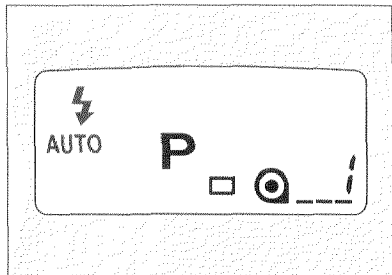



With programmed autoexposure (P mode), the camera begins measuring the light level of your subject and the surrounding scene as soon as Eye-Start activates the camera. If it determines that flash is required, the built-in flash will raise immediately and fire whenever necessary. When the grip sensor is no longer activated, or the main switch is turned off, the built-in flash will automatically lower. To fire flash at any time regardless of lighting, hold the flash-control button down while you take the picture (see manual fill-flash section, p.46).





- If the built-in flash is up and not required, it will not fire when shutter is released, and will lower after you take picture.
- The shutter will lock while the built-in flash is charging to prevent underexposure.

#### **Be careful...**

When using the built-in flash, lens shadowing may occur in your photograph if you are using a lens hood or subject is within one meter of the camera. To prevent lens shadowing, remove lens hood and make sure your subject is farther than one meter away before you take the photograph.

## Viewfinder signals

- The flash-on indicator  appears in the viewfinder data panel to indicate that the flash will fire when the next picture is taken.
- The flash-ready indicator  will appear when flash is fully charged. If pre-flash is selected,  will appear (see next section).
- After shutter is released, if flash output was sufficient to provide correct exposure, the flash-ready indicator will blink.

Viewfinder Display	Meaning
	Flash charging.
	Flash charged (pre-flash not selected)
	Flash charged (pre-flash selected)
 blinking	Flash output sufficient (pre-flash not selected)
 blinking	Flash output sufficient (pre-flash selected)

### Pre-flash

In photos of people, sometimes the subject's eyes appear to glow bright pink or red. This is caused by light from the flash reflecting from the retina of the eyes into the lens. This camera has a pre-flash feature which reduces "red-eye". In pre-flash mode when you press the shutter-release button all the way down, the flash will fire a series of small bursts before the main burst. This causes your subject's pupils to close slightly and greatly reduces the amount of light which will reflect off the retina.

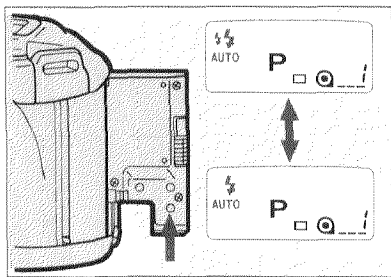

#### To select pre-flash:

Open the card door and press the pre-flash button once so that "  " appears in the body data panel. The pre-flash will fire before every flash exposure.

#### To cancel pre-flash:

Open the card door and press the pre-flash button again; "  " will appear in the body data panel.

- Pressing the program-reset button will not cancel pre-flash.
- When you use pre-flash, warn your subject before you take the picture that the flash will fire several times so that they know what to expect.
- The built-in flash also acts as the camera's AF illuminator. Canceling pre-flash **will not** cancel the AF-illuminator flash. See p.32 for details.



# **OPERATIONS IN DETAIL**

## Autofocus illuminator

In low-light and when subject contrast is too low to be read by the autofocus sensors, the built-in flash will automatically fire a series of low-power bursts when you press the shutter-release button partway down. This provides focus-assist lighting for the AF system to operate normally even in complete darkness.

### To cancel AF illuminator:

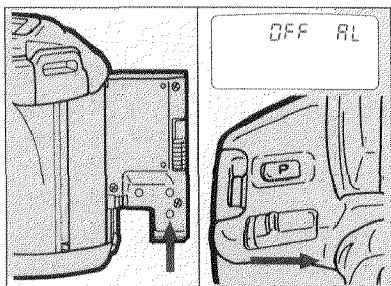

Press and hold the pre-flash button down while you slide the main switch from **LOCK** to **ON**.

"OFF RL" will appear in the body data panel.

- To re-activate the AF illuminator, repeat the above procedure. "On RL" will appear in the body data panel.
- The AF illuminator will not work in P mode if the flash is not necessary or if you have canceled it, or in A, S, or M mode if the flash is down.
- Canceling pre-flash will not affect the AF illuminator.
- The range of the AF illuminator is approximately 1-5m (3.3-16.4ft.).

## Special focusing situations

The camera's autofocus system will produce sharp pictures in almost every situation. In the cases described below, however, it may be difficult or impossible for the camera to autofocus properly—manual focusing may be necessary (see p.34).

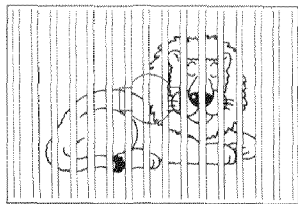

If two subjects at different distances overlap within the focus frame

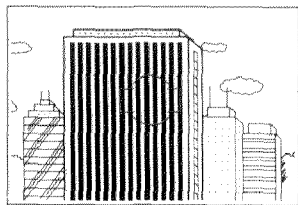

If a subject composed of alternating light and dark lines completely fills the focus frame

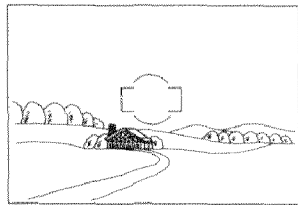

On very bright or low-contrast subjects

- You can also first lock focus on another object of equal distance and then recompose your picture (see p.26).

## Manual focus

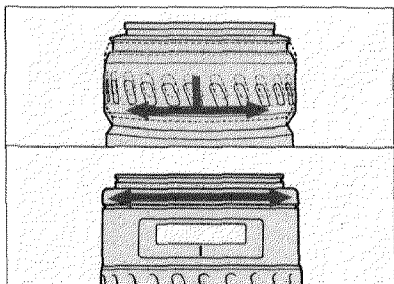
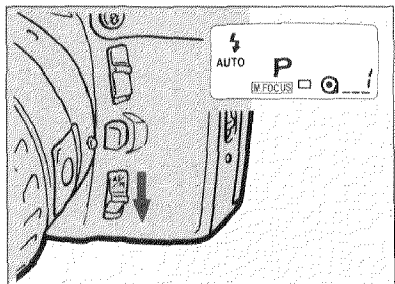

### To manually focus the lens:

1. Slide the focus-mode switch down to set the camera to manual focus mode.

**M.FOCUS** will appear in the body data panel.

2. If you are using an xi-Series lens or AF power zoom lens, pull and turn the control ring. With an AF lens, turn the focusing ring until the subject appears sharp. For more information, refer to the lens manual.

- When your subject comes into focus, ● will light in the viewfinder.
- To return to autofocus mode, slide the focus-mode switch down.
- Pressing the program-reset button will return the camera to autofocus mode and will also change all of the programmable functions to their default settings.
- In manual focus mode, the shutter will release even if the subject is not in focus.

## PA/PS: Creative program control

The camera's Expert Program Selection will determine the best combination of shutter speed and aperture for almost any scene or situation. If, however, you would like to temporarily use a different shutter speed or aperture, Creative Program Control allows you to do so.

### To select PA or PS:

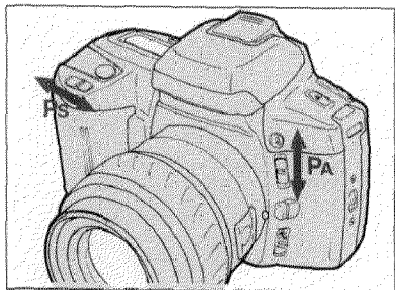

While in P mode, simply slide the aperture-setting control for PA or shutter-setting control for PS to select a different aperture or shutter speed. PA or PS will appear in the body data panel.



- If **P** appears in the viewfinder data panel, Creative Program Control will not function until you cancel the flash or the flash is no longer necessary.
- The camera will return to P mode automatically 4 sec. after it no longer detects an object near the viewfinder.
- To return to P mode, press the program-reset button; to return to P mode and keep any changes you have made to the camera's programmable functions, press the flash-control button.
- The flash will not fire manually or automatically while you are in PA or PS.
- The shutter-speed or aperture display will blink if the subject is too bright or too dark. Slide the aperture or shutter-setting control until neither display is blinking.
- If the metering indicators **▶** **◀** blink in the viewfinder data panel, the light level is beyond the range of available apertures and shutter speeds.

## Changing exposure mode

The camera has four exposure modes: programmed autoexposure (P, PA/Ps), aperture-priority autoexposure (A), shutter-priority autoexposure (S), and manual exposure (M). In P mode, Expert Program Selection automatically evaluates such factors as subject distance, brightness, and movement as well as focal length before it sets aperture and shutter speed. It will then optimize the exposure settings based on the particular requirements of the situation at hand. There is no single program line for each focal length, and no special modes to set manually for different situations.

If you want more creative control over the camera's exposure settings, use A, S, or M mode. Each mode is explained in following sections.

### To change exposure mode:

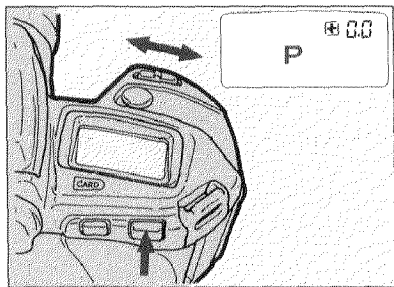

1. Press and hold the function button while you slide the shutter-setting control.

2. When you release the function button, the mode you have selected will be entered automatically.

- Pressing the program-reset button returns the camera to **P** mode and resets the camera's programmable functions to their default settings.

## A: Aperture priority

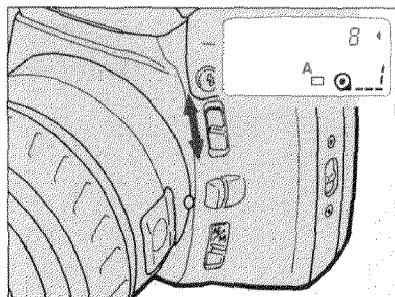
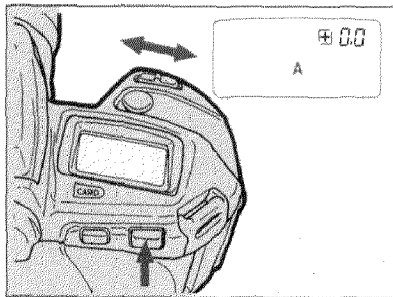

This mode allows you to set the aperture you want, giving you greater depth of field control (see p.58). If the shutter speed is available, the camera will automatically select it to maintain a correct exposure.

1. Refer to p.36 (Changing exposure mode) and select **A**. A pointer will appear next to the aperture display.
2. To select the aperture, slide the aperture-setting control up or down.
  - The aperture display in the data panels will change in 1/2-stop increments.
  - Available apertures are limited to those within the range indicated on the lens you are using.
  - The shutter speed display will blink if the required speed is beyond the range of the camera. If "2000" blinks, slide the aperture-setting control down to set a smaller aperture (larger f-number); if "30" blinks, slide the aperture-setting control up to set a larger aperture (smaller f-number).
  - If the metering indicators ▶ ◀ blink in the viewfinder data panel, the lighting is beyond the range of available apertures and shutter speeds.

### S: Shutter priority

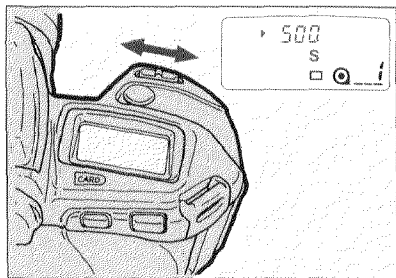
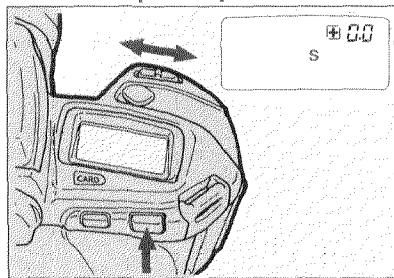

This exposure mode lets you select a shutter speed and allows you to control image blur (see p.60). If the lens you are using allows, the camera will automatically set the correct aperture to ensure a proper exposure.

1. Refer to p.36 (Changing exposure mode) and select **S**. A pointer will appear next to the shutter speed display in the body data panel.
2. To select the shutter speed, slide the shutter-setting control to the left or right.
  - The shutter-speed display in the data panel will change in 1-stop increments.
  - If the aperture display blinks, the aperture required to provide correct exposure at the shutter speed you have selected is not available. If the lens' maximum aperture blinks, slide the shutter-setting control to the left, decreasing the shutter speed; if the minimum aperture blinks, slide the shutter-setting control to the right, increasing shutter speed.
  - If the metering indicators ▶ ◀ blink in the viewfinder data panel, the light level is beyond the range of available apertures and shutter speeds.
  - You cannot select **bulb** in **S** mode.