

MINOLTA

E INSTRUCTION MANUAL

MAXXUM[®]

7000i

DATA PANEL

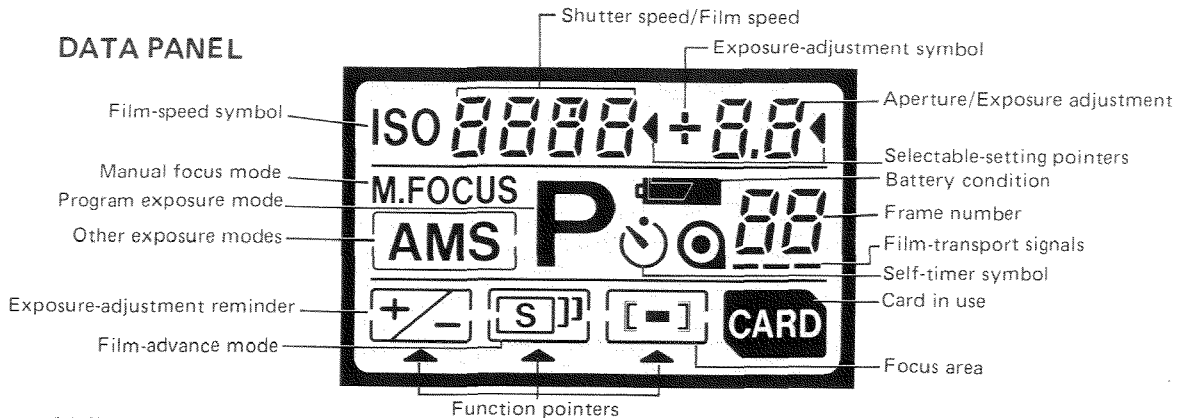

VIEWFINDER

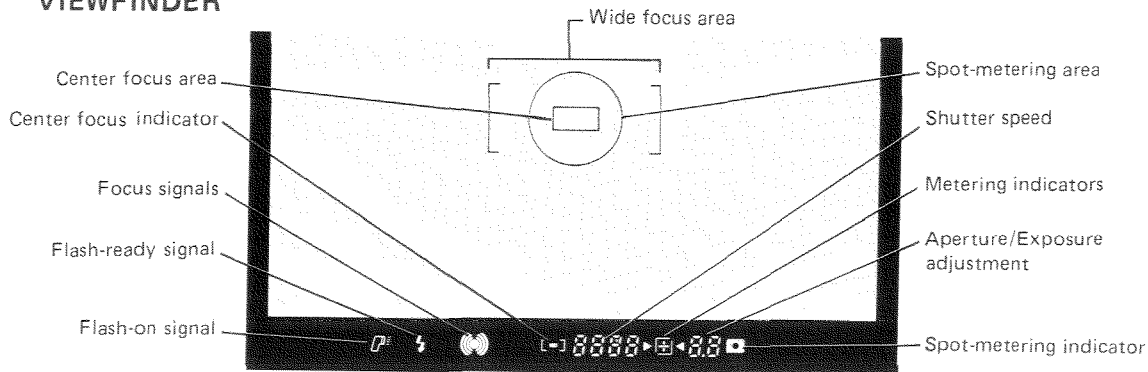

NAMES OF PARTS

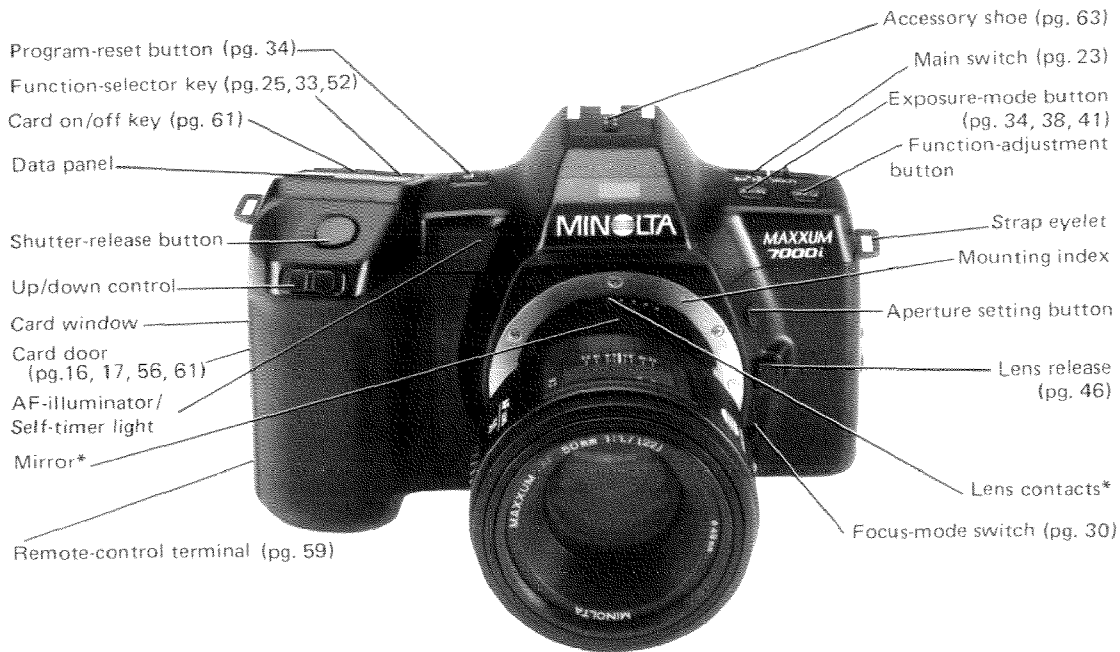

*** Do not touch**

Page number in parentheses indicates where to locate information about the part.

Your new Maxxum 7000i camera is the world's first truly intelligent autofocus SLR camera. All of the camera's functions are integrated for unparalleled ease of operation and ultimate precision. You can take sharply focused, properly exposed pictures one after another and rely on your Maxxum 7000i to deliver outstanding results from one roll of film to the next.

The following are the Maxxum 7000i's most impressive features:

- Intelligent autofocusing with predictive focus control and multiple autofocus sensors that enable faster, more precise focusing than ever before possible.
- Intelligent automatic exposure using the world's first multi-pattern metering system coupled to the autofocus system.
- Advanced automatic multi-program selection that instantly selects the exposure program for any lens you use.
- Intelligent automatic flash control to ensure perfectly exposed pictures in daylight, low light, or no light at all.
- Automatic film transport that enables taking sharply focused pictures at up to 3 frames per second.
- World's largest selection of autofocus system accessories, including Creative Expansion Cards, Maxxum Flash units, and more than 31 Maxxum autofocus lenses.

You probably want to begin using your new camera right away. But before you start, please read through this instruction manual to learn how your Maxxum 7000i operates.

TABLE OF CONTENTS

BASICS

ATTACHING THE LENS	4
ATTACHING THE NECKSTRAP	6
PUTTING THE CAMERA IN ITS CASE	8

BATTERY INFORMATION

Loading the battery	9
Battery check	10

FILM INFORMATION

Loading film	12
Film speed setting	15
Film rewind	17

TAKING PICTURES

Holding the camera	19
Fully automatic operation	20

MAKING THE MOST OF YOUR CAMERA

MAIN SWITCH	23
Audible signals	23

FOCUSING

Focus-area selection	24
Automatic focusing	26
How to use focus hold	27
Manual focusing	30

FILM-ADVANCE MODES

Single-frame advance	33
Continuous advance	33

EXPOSURE CONTROL

Program Mode	34
Program reset button	34
Aperture-priority mode	38
Shutter-priority mode	41
Manual mode	44
Aperture and shutter-speed settings	47
Metering system	48
Spot measurements	49
Exposure adjustment	51

FLASH INFORMATION 54

OTHER FUNCTIONS

Self-timer	56
Long exposures	58

ACCESSORIES 61

TROUBLESHOOTING GUIDE 68

TECHNICAL DETAILS 70

CARE AND STORAGE 75

IMPORTANT INFORMATION

The Minolta Maxxum 7000i camera is designed to offer innovative functions and performance through the combination of the camera body, Maxxum AF lenses, Minolta Maxxum Flash units, and other accessories distributed by Minolta. We thus caution users that the attachment or use of incompatible lenses, flashes, and accessories may result in unsatisfactory performance or damage to the Minolta Maxxum 7000i camera. To obtain optimum performance throughout the life of your Minolta Maxxum 7000i camera, we recommend that you use only lenses, flashes, and other accessories distributed by Minolta for the Maxxum 7000i camera.

BASICS

Lens	4
Neckstrap	6
Camera Cases	8
Battery	9
Film	12

ATTACHING THE LENS

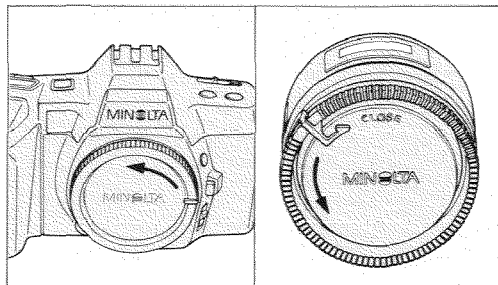

To attach:

1. Remove body cap and rear lens cap as shown.

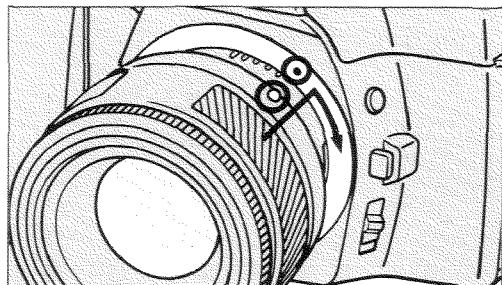

2. Align red bead on lens barrel with red dot on camera's lens mount. Insert lens bayonet into mount and turn lens clockwise until it locks in place with a click.

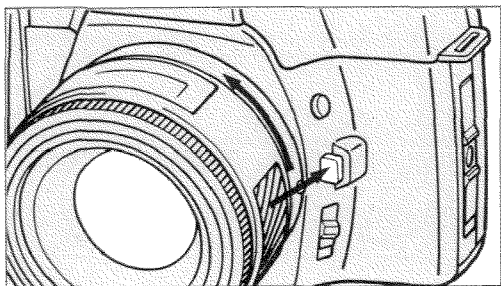

To remove:

1. While pressing lens release, turn lens counterclockwise as far as it will go, then lift lens out of mount.
2. Attach another lens or the body cap to prevent dust from entering the camera.

When the camera is set to A or M mode and the lens is removed, the aperture display in the data panel and viewfinder shows “- -”.

NOTE

- When attaching or removing lenses, never touch anything inside the camera, especially the lens contacts or mirror.
- To protect the lens contacts and the lens elements, attach the lens caps whenever the lens is not in use.

Care Of Glass Surfaces

- Never touch lens elements or the camera’s eyepiece with your fingers. If the lens becomes dirty, clean it gently with a lens brush. Only if necessary, moisten a sheet of lens tissue with one drop of lens-cleaning fluid. Then, starting at the center and using a circular motion, lightly wipe the surface of the lens.
- Never lift the mirror or touch its surface, as this may impair its alignment. Dust specks on the mirror’s surface will not affect exposure or picture quality. If the dust specks are annoying, the camera can be cleaned at an authorized Minolta service facility.

ATTACHING THE NECKSTRAP AND EYEPIECE CAP

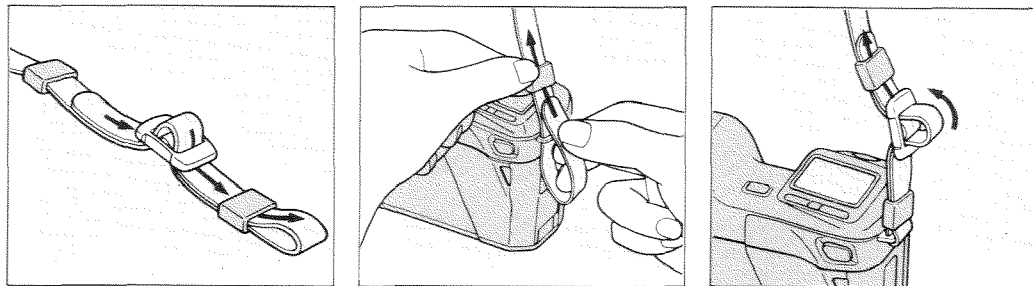

A neckstrap is supplied with your Maxxum 7000i. Attach it to the camera as shown above. An eyepiece cap is also supplied and can be slipped onto the neckstrap to keep it handy for use.

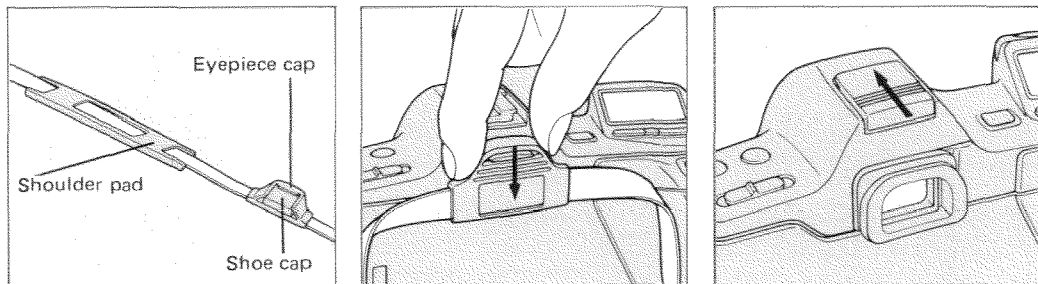

The eyepiece cap slides over the eyepiece frame to prevent stray light from entering the eyepiece and affecting exposure. It should be used whenever the eyepiece is not shielded by your head, as when using the self-timer or when operating the camera by remote control. To attach the eyepiece cap, first remove the Eyepiece Cup EC-7, then slip the cap over the frame.

An accessory shoe cap is supplied that slips into the accessory shoe to protect the contacts from dust and grime. When using a flash unit, slip the accessory shoe cap into the eyepiece cap.

PUTTING CAMERA IN ITS CASE

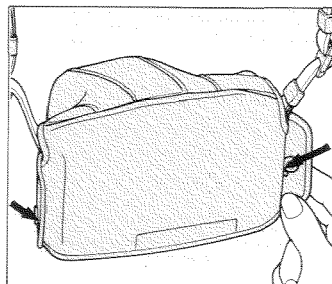
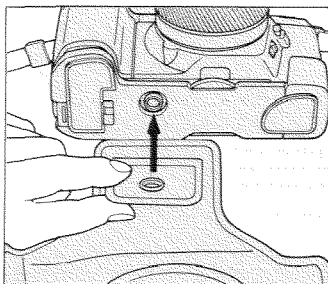
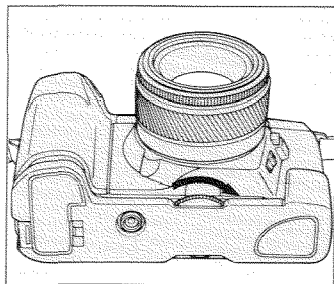

Various camera cases are available as optional accessories for the Maxxum 7000i.

To put camera in its case:

1. Attach lens cap.
2. If using a zoom lens, turn zoom ring until lens barrel is at its shortest position.
3. Follow the diagrams to put camera into case.

BATTERY INFORMATION

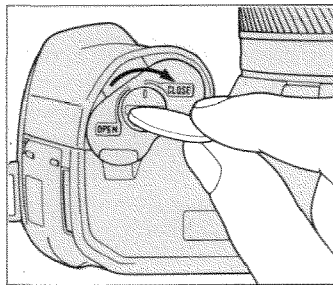
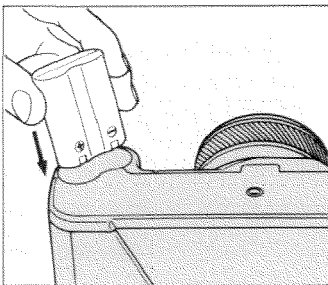
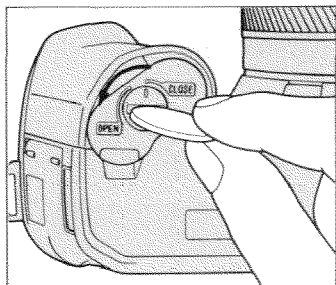

The Maxxum 7000i uses a 6-volt 2CR5 lithium battery. This battery supplies power for all camera operations, including film winding, autofocusing, and exposure control.

Loading The Battery

1. With main switch at LOCK position, use a coin or similar object to turn the battery-cover lock to OPEN position. Remove battery cover from camera.

2. Wipe battery terminals with a dry cloth to ensure proper contact. Insert the lithium battery according to the marks in the battery compartment.

3. Replace battery cover and turn the battery-cover lock to CLOSE position to secure it.

NOTE

- Read and follow all warnings and instructions supplied by the battery manufacturer.
- Keep battery away from young children.
- Do not attempt to disassemble, recharge, or short out the battery, or subject it to high temperatures or fire. The battery may explode and cause burns.

Checking The Battery Condition

Each time you slide the main switch from LOCK to ON or  position, the camera automatically checks the battery's condition:

Full-battery symbol appears for five seconds when power is sufficient.

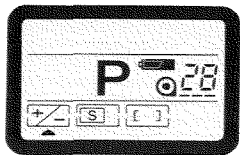

Low-battery symbol appears for five seconds: Power is getting low – keep a fresh battery handy.

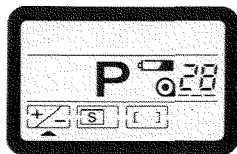

Low-battery symbol blinks: Camera can be operated, but the battery will need to be changed soon.

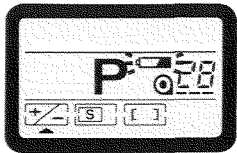

Blinking low-battery symbol appears alone or no indications appear: power is too low for normal operation — change battery immediately. (Note: in this case the shutter locks and the camera may also beep for one second as an additional low-battery signal.)

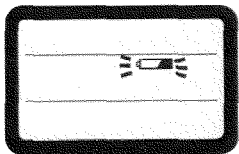

Cold-weather Operation

Lithium batteries provide excellent performance in cold weather. However, if you plan to shoot many rolls of film outdoors at 32°F (0°C) or below, we recommend that you carry the camera inside your coat to keep it warm when you are not taking pictures. You may also wish to carry a spare battery in a warm pocket, so that you can change the battery, if necessary. In this case, do not discard a cold battery since its capacity may be restored when it warms up.

Battery Performance

The 6-volt 2CR5 lithium battery should provide sufficient power for shooting up to 65 rolls of 24-exposure film, 50 rolls of 36-exposure film.

These figures are based on Minolta's standard test method using a fresh battery at 68°F (20°C). Actual battery performance will depend on how you use your camera.

FILM INFORMATION

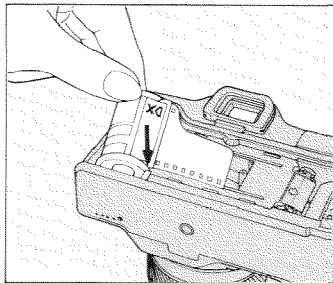
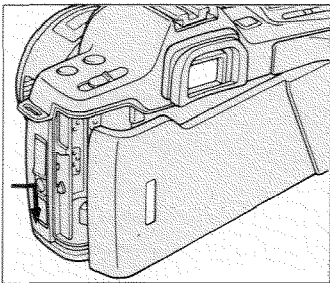
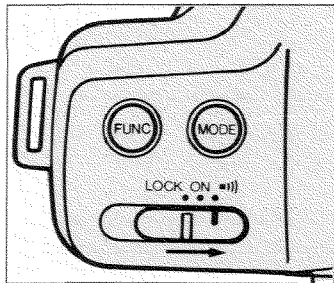

Loading Film

1. Set the main switch to ON or position.
2. Check the frame counter. When the frame counter shows "0" or if no number is displayed, it is safe to open the back cover.
 - The film window can also be used to check whether film is already loaded in the camera. Refer to page 17 if you want to rewind a partially exposed roll of film.

3. Open the back cover by pressing the button in the center of the back-cover release and sliding the release downward.
 - Always load film in subdued light or at least shaded from direct sunlight.
 - When you load film for the first time, remove and discard the protective plastic cover which is attached to the pressure plate.
4. Place film cartridge in film chamber as shown here.

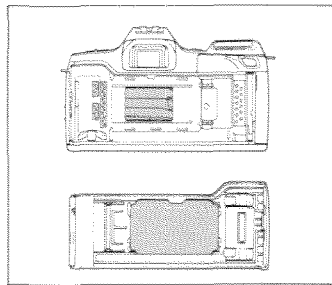
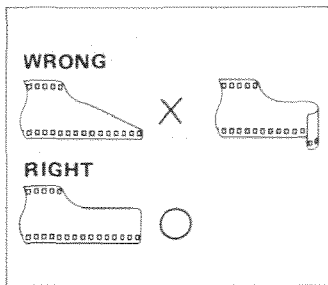
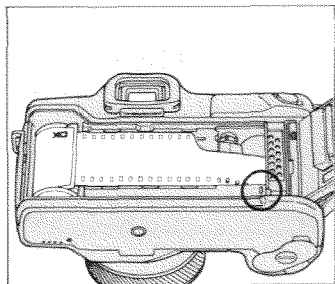

5. Extend the tip of the film past the red mark. Make sure the holes in the lower edge of the film engage the teeth on the sprocket.

- If the film extends too far or does not lie flat, gently push the excess film back into the cartridge.

- Make sure the tip of the film is shaped correctly. Otherwise, the film may not wind properly.

- Do not touch any parts or areas shown in blue.

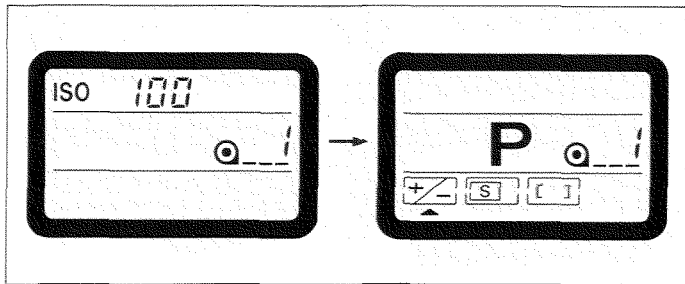
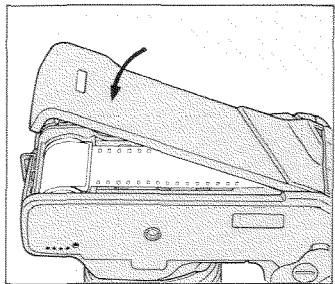

6. Close the back cover and make sure it snaps shut. The camera will automatically wind the film to the first frame. When the film is loaded correctly, the number "1" appears in the frame counter. If you are using DX-coded film, the film speed is set automatically and displayed for 5 seconds. You are now ready to start taking pictures.

- If the film is not loaded correctly, the frame number and film-transport signals "0_0" will blink, the camera will beep for one second and the shutter cannot be released. Repeat steps 3 through 6.

Automatic Setting Of The Film Speed

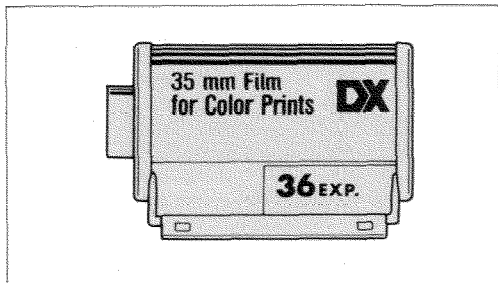

If you are using a DX-coded film, the camera sets the film speed automatically. The film-speed setting is displayed in the data panel for five seconds after the film is loaded.

- All DX-coded films have "DX" printed on their film cartridges and film boxes.

Manual Setting Of The Film Speed

If you are not using DX-coded film (i.e., "DX" is not printed on the cartridge and film box), you must manually set the correct ISO film speed. When desired, you can override the DX-coded film speed and reset the film speed to a higher or lower value. The film speed can be set from ISO 25 to ISO 6400. To set the film speed manually, see next page.

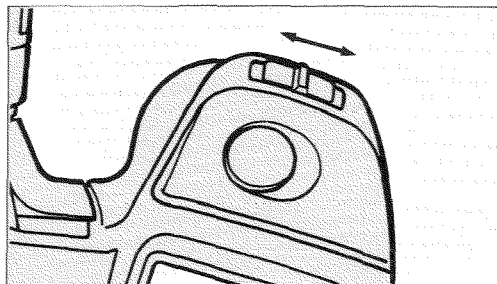
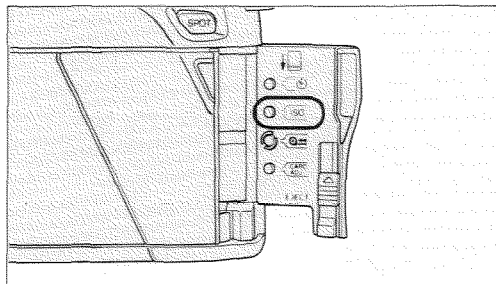

To set the film speed manually:

1. Open the card door on the right side of the camera.
2. Press the film-speed () button. Lift your finger from the button. The current film-speed setting will be displayed in the data panel next to the "ISO" symbol.

3. Move the up/down control to the left to set a lower film speed and to the right to set a higher film speed.

- Each time you move the up/down control, the film speed changes by 1/3 of a stop. The speed changes rapidly if you hold the up/down control in either position.

4. After the desired film speed is set, press the shutter-release button lightly to return to the normal operating mode.

- The normal display returns after 5 seconds.
- You can check the film speed at any time by pressing the film-speed () button.

Automatic Film Rewind

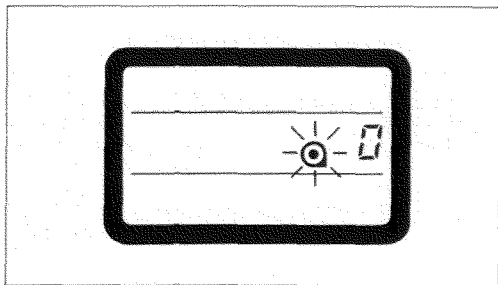

After the last frame is exposed, the camera automatically starts rewinding the film. When a fresh battery is loaded in the camera, it normally takes about ten seconds to rewind a 36-exposure film and about eight seconds for a 24-exposure film.

When the film is completely rewound, the rewind motor switches off automatically. The film-cartridge symbol blinks in the data panel to indicate that you can remove the film.

- The film leader will be wound all the way into the cartridge. If you want the film leader to be left out after the film is rewound, you can use the Customized Function Card to change this function. See page 61 for more details about this and other Creative Expansion Cards.
- If you accidentally open the camera's back cover before the film is rewound, close the back cover immediately and press the rewind button to finish rewinding the film. Light falling on the film will ruin many of the pictures; however, your quick action may save a few pictures.
- If it's necessary to change the battery before rewind is completed, press the rewind button to restart.

Manual Start of Film Rewind

You can also rewind and remove a roll of film before the last exposure is taken. To start film rewinding, simply open the card door on the right side of the camera, and press the rewind () button.

TAKING PICTURES

TAKING PICTURES

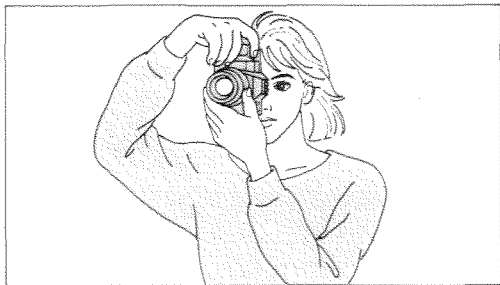

Holding The Camera

This section explains the basic steps for using program exposure mode, autofocus, and single-frame film advance. Detailed information about each of the camera's functions begins on page 22.

To obtain sharp, blur-free photos, hold the camera as still as possible and steady it against your face or body. Press the shutter-release button gently with a slow, steady squeeze — never a quick jab.

Two recommended ways of holding the camera are shown here. If you grasp the camera firmly with your right hand on its handgrip, you can shift the camera back and forth for horizontal and vertical pictures without removing your hands from the controls. **When using autofocus, make sure you do not touch the lens' focusing ring.**

Fully Automatic Operation

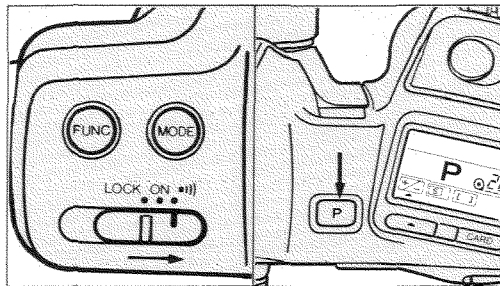

1. Slide the main switch to **•|||** position, then press the program-reset (P) button to set the camera for fully automatic operation.

● Whenever the program-reset button is pressed, the camera is set to program exposure mode, autofocus, single-frame film advance, ± 0.0 exposure adjustment, and wide focus area.

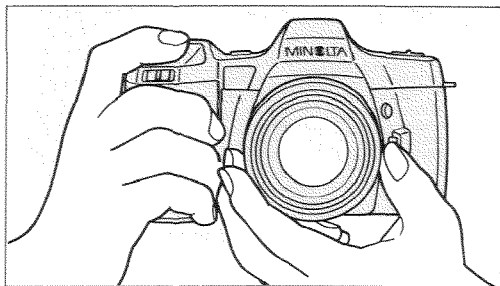

2. Hold the camera firmly in your right hand and support the lens with your left hand.

● Do not touch the lens' focusing ring, as this prevents the lens from focusing properly.

3. While looking through the eyepiece, center the focus frame on your subject and press the shutter-release button partway down. The camera will focus automatically, and the exposure settings will be displayed in the viewfinder and data panel.



- A green focus signal in the viewfinder glows when the subject is in focus.
- If a red focus signal blinks, you should focus the lens manually or use focus hold (see page 27).
- If the camera beeps continuously, the shutter speed is too slow to ensure sharp pictures. Attach a flash unit or mount the camera on a tripod.

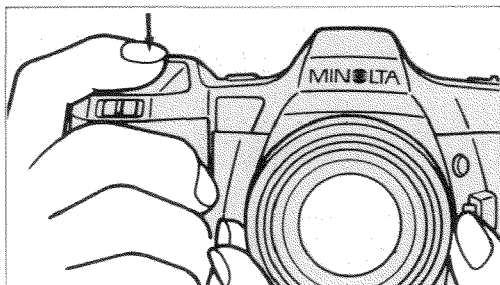



4. To take a picture, gently press the shutter-release button all the way down. Use a smooth, steady squeeze — never a quick jab which might shake the camera and cause a blurred picture.
- After the exposure is made, the film is automatically advanced to the next frame and the frame number increases by one.

MAKING THE MOST OF YOUR CAMERA

Main Switch	23
Focusing	24
Film-advance Modes	33
Exposure Control	
Program mode	34
Aperture-priority mode	38
Shutter-priority mode	41
Manual mode	44

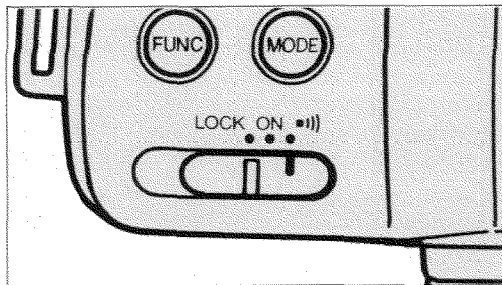

MAIN SWITCH



The main switch has three positions: LOCK, ON, and . At ON and  positions, you can take pictures and all camera functions will operate. At LOCK position, all camera functions are switched off.

When the camera is not in use, we recommend setting the main switch to LOCK to prevent taking accidental exposures and ensure optimum battery life.

Audible Signals

With the main switch at ON or  position, the camera beeps for one second to warn that the film has been loaded incorrectly. The camera will also beep if battery power becomes too low for continued operation. This signal will occur when the main switch is moved from LOCK to ON or  position.

With the main switch is at  position, the camera beeps when the subject comes into focus, when the shutter speed is too slow for taking hand-held pictures in program (P) or aperture-priority (A) mode, and when using the self-timer.

FOCUSING SYSTEM



Focus-area Selection

The Maxxum 7000i camera has three auto-focus sensors, a horizontal sensor in the center of the frame and vertical sensors on each side of the center sensor. When the camera is set to "wide" focus area, all three sensors are used to determine correct focus. When the "center" focus area is selected, only the horizontal sensor is used.

Wide Focus Area

The wide focus area is set automatically by the camera when you load a battery or when you press the program reset (P) button. This is the camera's normal setting, and it is ideal for most situations, especially when taking pictures of fast-moving subjects. Even if the main subject is not in the exact center of the frame, the camera will focus correctly.

Center Focus Area

If the camera is set to wide focus area, it may be difficult to focus on one person standing in a crowd, since more than one subject will fill the focus area. By selecting the center focus area, you can limit the focus area to the small area marked in the center of the viewfinder. The center focus area is also useful when you are taking close-up photographs.

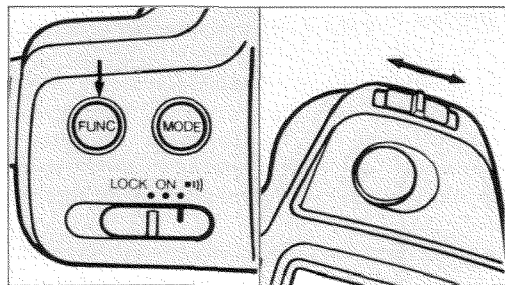
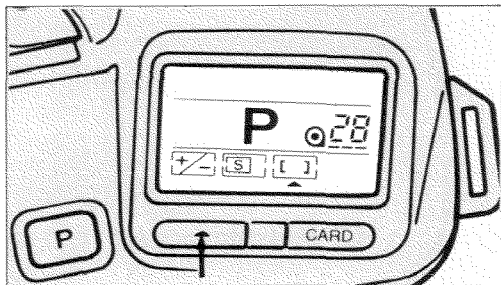

To select the focus area:

1. Press the function-selector (\blacktriangleleft) key to move the function pointer under the focus area indicator.
2. Hold down the function-adjustment (FUNC) button and move the up/down control in either direction to select center (\blacktriangleleft) or wide (\blacktriangleright) focus area.

- Both focus-area settings can be used with autofocus and manual focus.
- An indication in the viewfinder appears when center focus area is selected.
- To quickly reset the wide focus area, you can press the program reset (P) button. This will also set the camera to program mode, autofocus, single-frame advance, and ± 0.0 exposure adjustment.

Autofocusing

Autofocus is the camera's "normal" focus mode. It is automatically set when you load the battery or press the program reset (P) button. The Maxxum 7000i has a built-in AF illuminator that is triggered automatically to permit autofocusing in case of low subject contrast or low light. In total darkness the Maxxum 7000i can focus on subjects up to 30 feet (9 meters) away.

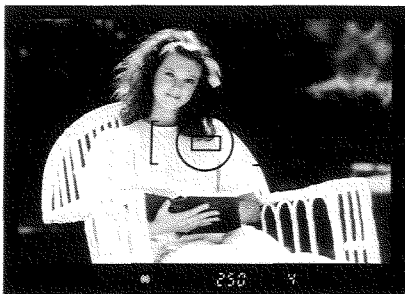

Focusing On Still Subjects

1. Center the focus frame on the subject.
2. Press the shutter-release button partway down to focus the lens.

- The green focus signal will glow when the subject is in focus.
- If the main switch is set to $\bullet \text{||}$, the camera will also beep when the subject comes into focus.
- 3. Press the shutter-release button all the way down to take the picture.
- The shutter can only be released when the green focus signal glows.

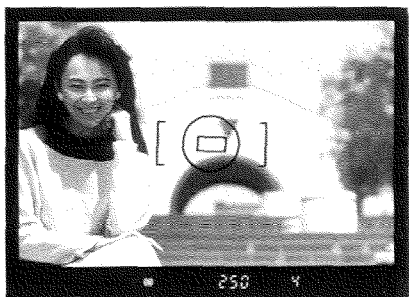

Focus Hold

With still (non-moving) subjects, the focus remains locked on the subject as long as you keep the shutter-release button pressed partway down. If you want to take a picture with the subject at the edge of the frame, first lock the focus on your subject, then recompose the picture and press the button all the way down to take the picture.

When you use focus hold, the camera automatically locks the exposure reading for the subject on which you have focused. You do not have to adjust the exposure after recomposing the picture. A basic explanation of the metering system begins on page 48.

If when you recompose the picture another subject at a closer distance than your main subject enters the autofocus zone, focus may not be locked.

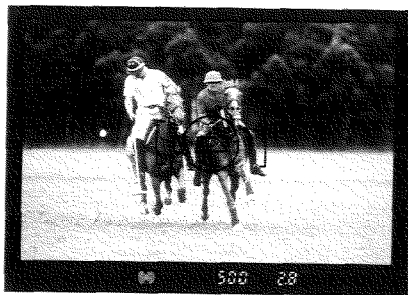
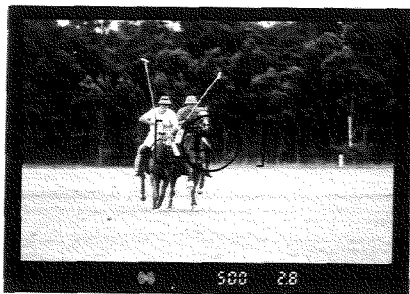

Continuous Autofocusing

The Maxxum 7000i automatically detects when the subject is in motion and adjusts focus continuously. To focus on moving subjects:

1. Center the focus frame in the viewfinder on your subject.
2. Press the shutter-release button partway down. The camera continually adjusts the focus as your subject moves.
3. To take a picture, press the shutter-release button all the way down.

- The shutter can only be released when the subject is in focus.
- If you are using continuous film advance mode, you can take a series of pictures by holding the shutter-release button down. The camera will automatically advance the film after each exposure, then readjust the focus before the next exposure is taken.

Autofocus Signals

Camera is focused on a moving subject. Focus will continue to be adjusted as the subject moves. Shutter can be released.



Focus is locked on a non-moving subject. You can recompose the picture and the focus will be held. Shutter can be released.



Subject is moving too fast for autofocusing. Shutter cannot be released.

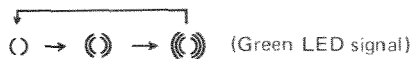

Autofocus is not possible due to very low contrast, low light, or because the subject is too close. Shutter cannot be released. Set camera to manual focus mode and turn lens' focusing ring until subject appears sharp in the viewfinder.



Manual Focusing

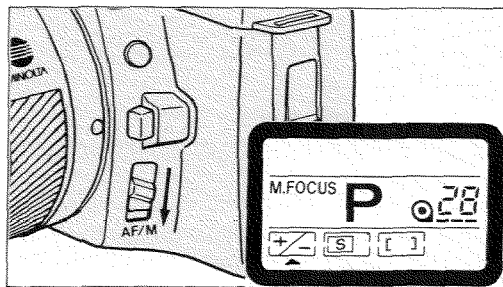

1. Slide the focus-mode (AF/M) switch downward to set the camera to manual focus mode. "M.FOCUS" will appear in the data panel. Sliding the switch again will reset the camera to autofocus mode.
2. Center the focus frame on the subject.
3. Press the shutter-release button slightly to activate the focus signals.

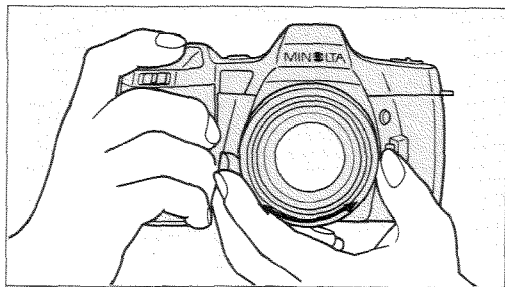

4. Turn the lens' focusing ring until the green focus signal glows and the subject appears sharp in the viewfinder. If the main switch is set to  position, the camera will emit a short beep when the subject comes into focus.

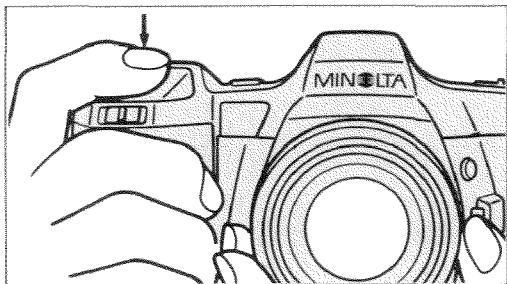

5. Press the shutter-release button all the way down to take the picture.

- When using manual focus, the shutter can be released at any time, even if the subject is not in focus.
- When you use manual focus mode, the exposure is based on center-weighted metering. For more information about the metering system, refer to page 48.

Manual Focus Signals

Subject in focus.

- (Green LED signal)

Focus cannot be confirmed by camera. Turn focusing ring until subject appears sharp in viewfinder.

- ⚡●⚡ (Blinking red LED signal)

Focusing In Special Situations

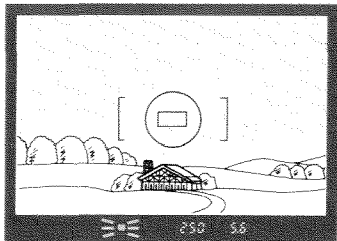

A

The camera's autofocus system enables taking sharply focused pictures in nearly any situation. Listed here are four situations when you may need to take extra steps to ensure sharp focus.

- If subject contrast is too low (A), focus manually until subject appears sharp in viewfinder.

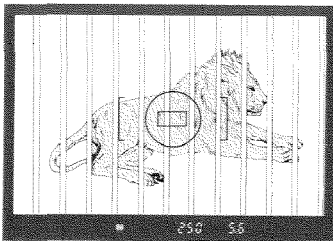

B

- For extremely bright subjects, use of a neutral-density filter is recommended.

- In cases where two subjects are at different distances within the focus frame (B) or it the subject has alternating lines within the focus frame (C), focus manually until subject appears sharp in viewfinder.

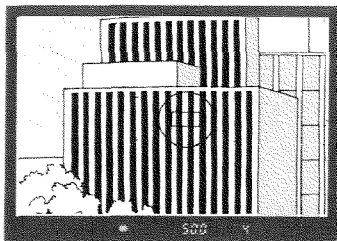

C

FILM-ADVANCE MODES

The Maxxum 7000i features two film-advance modes. In single-frame mode, the film is advanced one frame after each exposure. In continuous mode, film is advanced continuously at up to 3 frames per second. In continuous mode, focus is automatically adjusted between exposures to ensure sharp pictures.

When you are using autofocus in either film-advance mode, the shutter can only be released when the subject is in focus. If you press the shutter-release button all the way down before the subject is in focus, the shutter will be released after the subject is focused.

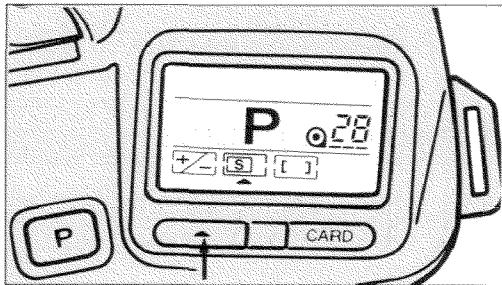

To select the film advance mode:

1. Press the function-selector (\blacktriangle) key to move the function pointer under the film-advance mode symbol in the data panel.
2. Hold down the function-adjustment (FUNC) button and use the up/down control to select between single-frame (\square S) and continuous (\square 1) modes.

EXPOSURE CONTROL

Program Mode

Program mode is designed as the Maxxum 7000i's main exposure mode. Whenever the camera is set to program mode, a large letter "P" appears in the data panel.

Program mode is ideal for general photography. In this mode, you just aim the camera and press the shutter-release button to take a picture. The camera automatically sets the correct exposure, no manual settings are required.

Program Reset Button

Whenever you want to use program mode, simply press the program-reset (P) button. Doing so sets the camera to program mode, autofocus mode, single-frame advance mode, wide focus area, and ± 0.0 exposure adjustment.

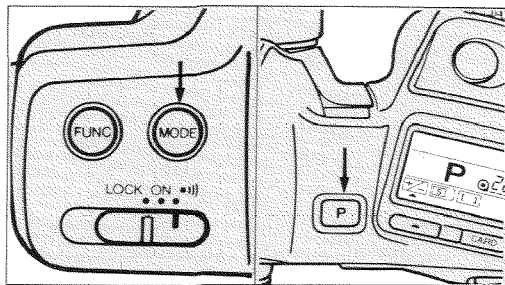

- You can also switch from A, S, or M mode to program mode by holding down the exposure-mode (MODE) button and pressing the program reset (P) button. Only the exposure mode will be change; no other camera settings will be affected.

Automatic Multi-program Selection

The Maxxum 7000i automatically selects the exposure program that is best suited to the lens in use. Program selection is completely automatic, so no manual settings are required. With a Maxxum AF lens attached, the camera instantly selects the programmed shutter speed and aperture combination that will provide optimum results. Each program is designed to select a shutter speed that is fast enough to minimize blur caused by camera shake.

When using a Maxxum AF zoom lens, exposure program is continuously adjusted as you zoom the lens. Thus if you turn the zoom ring, you will notice that the shutter speed and aperture settings change.

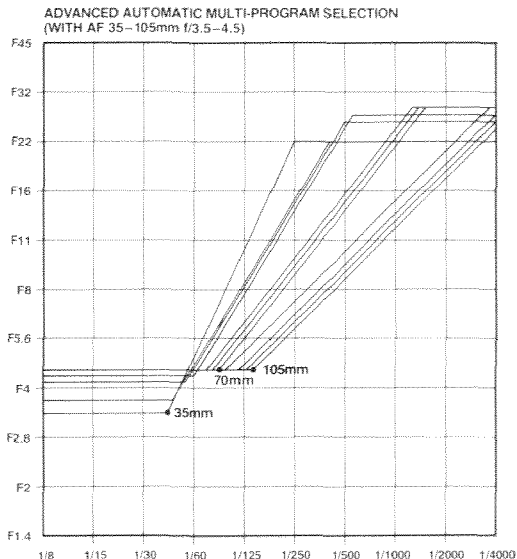

Program Shift

Program shift lets you select other aperture-shutter combinations without changing the exposure. The program can be shifted in half-stop increments. Sliding the up/down control to the left selects slower shutter speeds with smaller apertures. A shift in this direction might be used to create a heightened sense of subject movement if the camera is panned during exposure. Sliding the up/down control to the right would shift the exposure towards faster shutter speeds and wide apertures.

NOTE

- Shifted settings are held for five seconds, after you lift your finger from the shutter-release button (when the meter switches off). To take several pictures using program shift, keep your finger on shutter-release button.
- When using zoom lenses, shift the program after zooming. If you change the focal length, the shifted settings will also change.
- When the lighting is too bright or too dark to ensure correct exposure, the metering indicators (► ◀) blink in the viewfinder. In low light, use a Maxxum Flash unit (see pages 54 and 63).

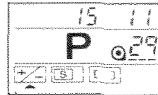
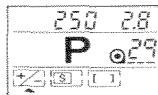
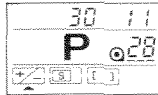
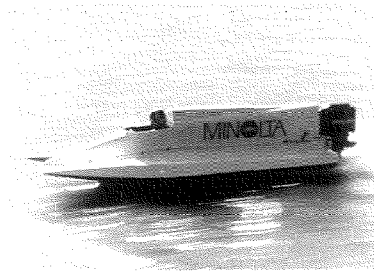
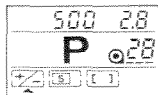
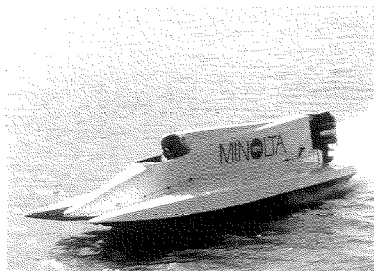

Aperture-priority Mode

In aperture-priority (A) mode, you can set the aperture to control sharpness in the picture and the camera automatically sets the shutter speed required for correct exposure.

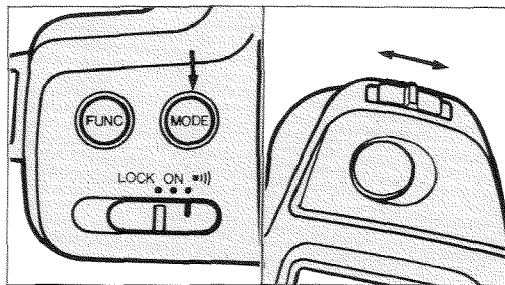

To select A-mode:

Hold down the exposure-mode (MODE) button, and slide the up/down control in either direction until "A" is displayed in the data panel. The pointer next to the aperture indicates that it can be set manually.