

MINOLTA

The essentials of imaging

www.minoltaeurope.com

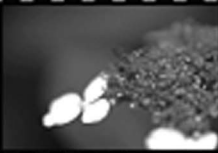
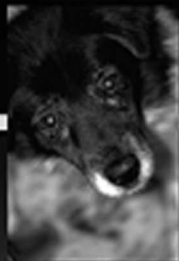

DiMAGE Scan Elite II

E **HARDWARE MANUAL**

FOR PROPER AND SAFE USE

Read and understand all warnings and cautions before using this product.

WARNING

- Use only within the voltage range specified on the unit. Inappropriate current may cause damage or injury through fire or electric shock.
- Use only the specified AC adapter (Delta Electronics ADP-20LB REV:B) within the voltage range indicated on the adapter unit. An inappropriate adapter or current may cause damage or injury through fire or electric shock.
- Do not disassemble this product. Electric shock may cause injury if a high-voltage circuit inside the product is touched. Take the product to a Minolta Service Facility when repairs are required.
- Immediately unplug the unit and discontinue use if the product is dropped or subjected to an impact in which the interior is exposed. The continued use of a damaged product may cause injuries or fire.
- Store this product out of reach of children. Be careful when around children not to harm them with the product or parts.
- Do not operate this product or handle the power cord with wet hands. Do not place a container with liquid near the product. If liquid comes in contact with the product, immediately unplug the unit. The continued use of a product exposed to a liquid may cause damage or injury through fire or electric shock.
- Do not insert hands, inflammable objects, or metal objects such as paper clips or staples into this product. It may cause damage or injury through fire or electric shock. Discontinue use if an object enters the product.
- Do not use the product near inflammable gases or liquids such as gasoline, benzine, or paint thinner. Do not use inflammable products such as alcohol, benzine, or paint thinner to clean the product. The use of inflammable cleaners and solvents may cause an explosion or fire.
- When unplugging the unit, do not pull on the power cord. Hold the plug when removing the cord from an outlet.
- Do not damage, twist, modify, heat, or place heavy objects on the power cord. A damaged cord may cause damage or injury through fire or electric shock.
- If the product emits a strange odor, heat, or smoke, discontinue use. Immediately unplug the product. The continued use of a damaged product or part may cause injuries or fire.
- Take the product to a Minolta Service Facility when repairs are required.

CAUTION

- This product should only be operated in the upright position. Inappropriate placement may result in fire.
- Damage or injury through fire or electric shock may result if the product is used or stored in the following conditions:
 - In humid or dusty environments
 - In direct sunlight or hot environments
 - In smoky or oily areas
 - In unventilated areas
 - On unstable or unlevel surfaces
- Insert the plug securely into the electrical outlet.

- Do not use if the cord is damaged.
- Do not connect the ground to a gas pipe, telephone ground, or water pipe. Improper grounding can result in injury from electric shock.
- Do not cover the AC adapter. A fire may result.
- Do not obstruct access to the AC adapter; this can hinder the unplugging of the unit in emergencies.
- Unplug the product when cleaning or when the unit is not in use for long periods.
- Periodically check that the power cord is not damaged and the plug is clean. Dust and dirt that may collect between the prongs of the plugs may result in fire.

Every necessary precaution has been taken to ensure the accuracy of this instruction manual. Minolta is not responsible for any loss or damage caused from the operation of this product. This manual may not be copied in part or whole without prior written permission from Minolta.



As an ENERGY STAR Partner, Minolta has determined that this product meets the ENERGY STAR guidelines for energy efficiency.



This mark certifies that this product meets the requirements of the EU (European Union) concerning interference causing equipment regulations. CE stands for Conformité Européenne.

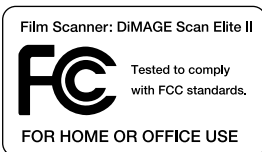

This device complies with Part 15 of the FCC Rules. Operation is subject to the following conditions: (1) This device may not cause harmful interference, and (2) this device must accept any interference received, including interference that may cause undesired operation. Do not remove the ferrite cores from the cables.

This Class B digital apparatus complies with Canadian ICES-003.

Cet appareil numérique de la classe B est conforme à la norme NMB-003 du Canada. Tested by the Minolta Corporation 101 Williams Drive Ramsey, New Jersey 07446 USA

The sound pressure level is less than 70dB according to ISO 3744 or ISO 7779.

Microsoft, Windows, Windows 98, Windows Me, Windows 2000 Professional, and Windows NT are registered trademarks of the Microsoft Corporation. Macintosh, Apple, and Power Macintosh are registered trademarks of Apple Computer, Inc. Adobe and Photoshop are registered trademarks of Adobe Systems Incorporated. CorelPhotoPaint is a trademark of the Corel Corporation. Paint Shop Pro is the copyright of Met's Corporation. Digital ICE3, Digital ICE, Digital ROC, and Digital GEM are trademarks of registered trademarks and technologies of Applied Science Fiction, Inc in U. S. A. Other corporate and product names are the trademarks and registered trademarks of their respective companies.

BEFORE YOU BEGIN

Thank you for purchasing this Minolta product. Please take the time to read through this instruction manual so you can enjoy all the features of your new scanner.

This manual contains information regarding products introduced before September, 2002. To obtain compatibility information for products released after this date, contact a Minolta service facility listed on the back cover of this manual. This product is designed to work with accessories manufactured and distributed by Minolta. Using accessories or equipment not endorsed by Minolta may result in unsatisfactory performance or damage to the product and its accessories.

Check the packing list before using this product. If any items are missing, immediately contact your dealer.

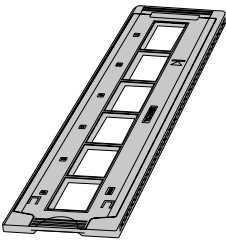

Film holder FH-U1



Scanner unit

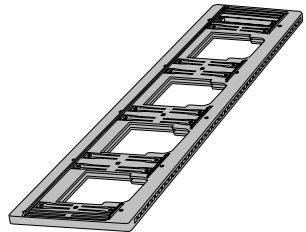

Slide mount holder SH-U1

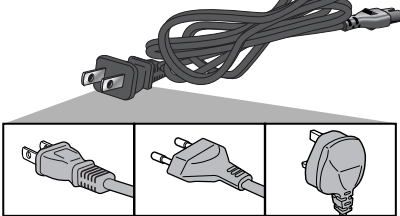
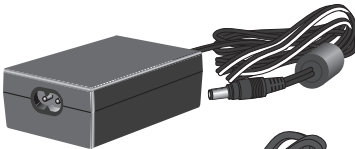

AC adapter AC-U10 with power cord. The shape of the plug varies with destination.

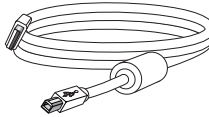

USB cable UC-1

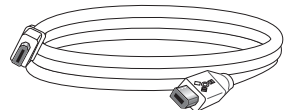

IEEE 1394 cable FC-1

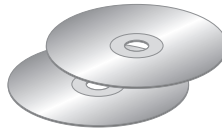

DiMAGE Scan Utility CD-ROM, DiMAGE Instruction Manuals-CD-ROM and Adobe Photoshop Elements CD-ROM

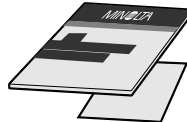

Quick Reference Guide, and warranty card

TABLE OF CONTENTS

This manual contains information specific to this model scanner. This includes hardware setup and use as well as notes about software operation for this model scanner. See the supplied DiIMAGE Scan Utility software manual for information on the installation and operation of the scanner software.

System requirements	6
Names of parts	7
Scanner setup	8
Before connecting the scanner to the computer	8
Connecting the USB cable	8
Connecting the IEEE 1394 (FireWire) cable	9
Connecting the AC adapter	9
Turning on the scanner	9
Loading the film holders	10
Handling film	10
Where is the emulsion?	10
Loading 35mm film strips	10
Loading mounted slides	11
Loading a film holder into the scanner	11
Using the APS Adapter AD-10 (sold separately)	12
Film format and type settings	13
Ejecting a film holder	13
Scanner notes	14
Adobe Photoshop Elements	14
Easy Scan Utility	14
About the DiIMAGE Scan Utility	14
Digital ICE3 system requirements	15
Scanner color profiles	16
Scanner resolution	16
Disconnecting the scanner	16
Job file lists	18
35mm	18
APS	19
Troubleshooting	20
Checking software installation - Windows	21
Technical support	22
Warranty and product registration	22
Technical specifications	23

SYSTEM REQUIREMENTS

The computer and the operating system must be guaranteed by the manufacturer to support IEEE 1394 (FireWire), or USB interface. To use the scanner, your computer system must meet the following requirements:

<p>Pentium 166 Mhz or later processor. Pentium III processor is recommended when scanning with 16-bit color depth. For memory requirements for Digital ICE3, see page 15. Operation is not guaranteed for custom or home built computers.</p>	<p>PowerPC G3 or later. PowerPC G4 or later is recommended when scanning with 16-bit color depth or using Digital ROC or GEM. For memory requirements for Digital ICE³, see page 15.</p>
<p>USB: preinstalled Windows 98, 98 Second Edition, 2000 Professional, Me, or XP. IEEE 1394: preinstalled Windows 2000 Professional, Me, or XP</p>	<p>USB: preinstalled Mac OS 8.6 to 9.2.2 and Mac OS 10.1.3 to 10.1.5 FireWire: preinstalled Mac OS 8.6* to 9.2.2</p>
<p>A minimum of 64MB (128MB with Windows XP) of RAM. For memory requirements for Digital ICE3, see page 15.</p>	<p>A minimum of 64MB of RAM in addition to the requirements for the Mac OS and applications. 128MB of RAM when scanning with 16-bit color depth. For memory requirements for Digital ICE3, see page 15.</p>
<p>100MB or more of available hard-disk space is required. 200MB or more is required when scanning with 16-bit color depth.</p>	
<p>640 x 480 monitor capable of displaying High Color (16 bit) is required. 1024 x 768 monitor is recommended.</p>	<p>640 x 480 monitor capable of displaying at least 32,000 colors is required. 1024 x 768 monitor is recommended.</p>
<p>IEEE1394 or preinstalled USB (ver.1.1) interface</p>	
<p>Recommended IEEE boards: Adaptec FireConnect 4300, PROCOMP SpeedDemon 400P or Preinstalled OHCI compatible non-DV dedicated IEEE1394 ports guaranteed by the computer manufacturer.</p>	<p>Preinstalled FireWire port.</p>
<p>TWAIN driver is compatible with Photoshop 5.0.2, 5.5 6.0, and 7.0, Photoshop LE 5.0, Photoshop Elements, Paint Shop Pro 7, CorelPhotoPaint9.</p>	<p>Plug-in is compatible with Photoshop 5.0.2, 5.5, 6.0 and 7.0, Photoshop LE 5.0, Photoshop Elements.</p>

* To use preinstalled Mac OS 8.6 with a built-in FireWire port, a Firewire 2.2 to 2.3.3 extension must be installed. This software can be downloaded free of charge from the apple web site at <http://www.apple.com>.

Check the Minolta web site for the latest compatibility information:

North America: <http://www.minoltausa.com>,

Europe: <http://www.minoltasupport.com>

NAMES OF PARTS

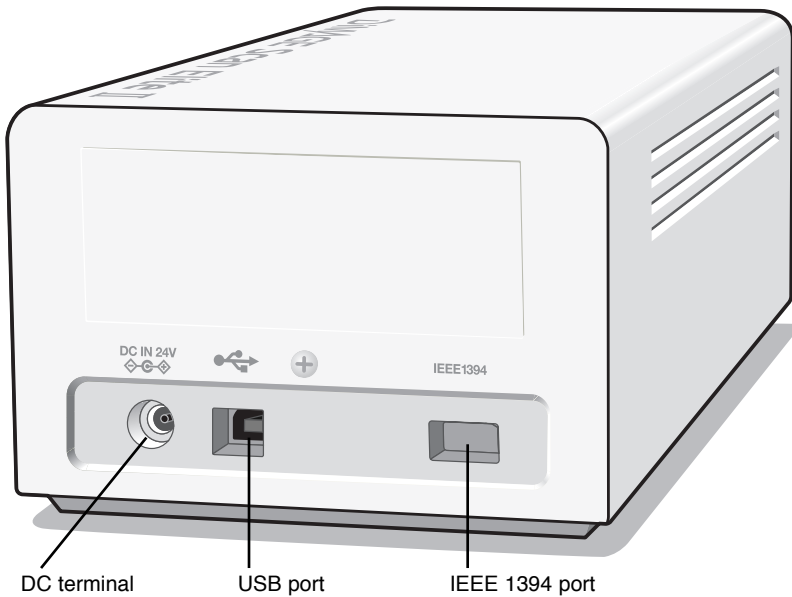
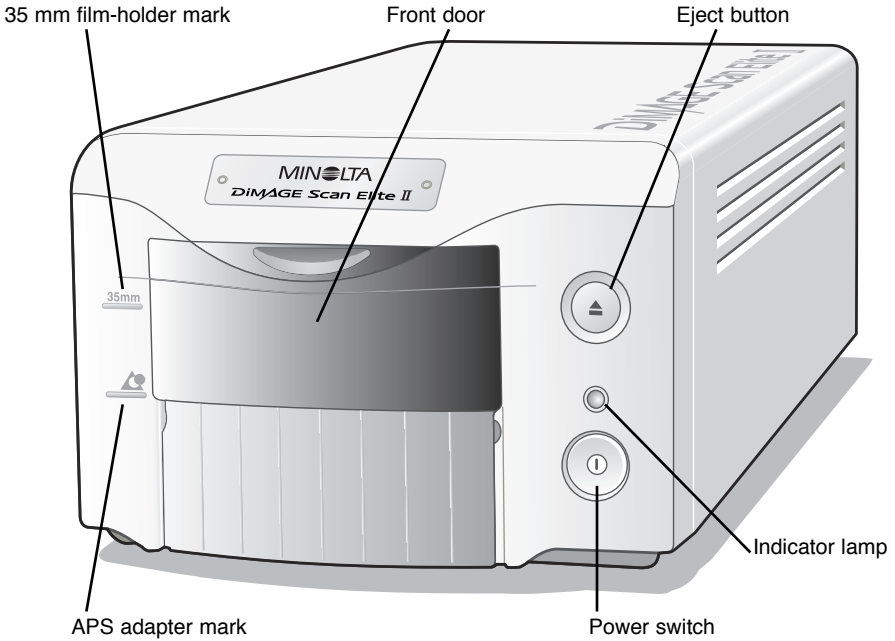

The unused port should be covered with its protective cap. When the scanner is stored, the cables should be removed and the caps replaced in the ports.

SCANNER SETUP

Before connecting the scanner to a computer

Before connecting the scanner to a computer, the DiMAGE Scan Utility must first be installed. Read the software instruction manual for the installation procedure.

The scanner should be placed on a level surface free from vibrations. It should be located away from direct sunlight and in a clean, dry, well-ventilated area.



The computer and all peripheral devices must be off before connecting the scanner.

Connecting the USB cable

Remove the protective cap from the USB port. Securely plug the A connector of the USB cable into the scanner's USB port and the B connector into the computer's USB port.

The scanner should be connected directly to the computer. Attaching the scanner to a USB hub may prevent proper operation.

When the scanner is initially connected to a computer with a Windows 98, 98SE, or 2000 Professional operating system, the found-new-hardware wizard will appear briefly. No action is required. With Windows 2000, the "Digital Signature Not Found..." message may appear. Click the yes button to complete the scanner installation.

When the scanner is initially connected to a computer with a Windows XP operating system, the found-new-hardware wizard will appear. Click the next button. The "not passed Windows Logo testing" message appears. Click the continue-anyway button to complete the scanner installation.

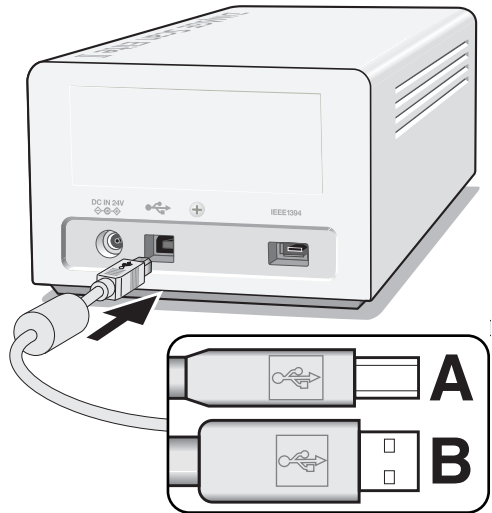

Connecting the IEEE 1394 (FireWire) cable

Remove the protective cap from the IEEE 1394 port. Securely plug the cable into the scanner's and computer's IEEE 1394 port. Either end of the cable can be connected to the IEEE 1394 port on the scanner or computer.

The scanner should be connected directly to the computer. Attaching the scanner to an IEEE hub may prevent proper operation.

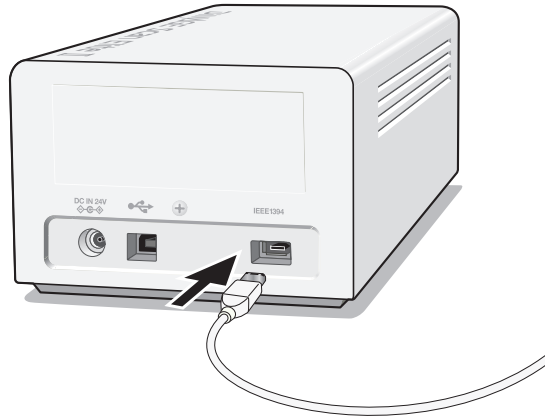

Connecting the AC adapter

Connect the power cable to the AC adapter unit (1). Connect the output plug of the AC adapter to the scanner's DC terminal (2). Plug the power cable into a standard household outlet (3).

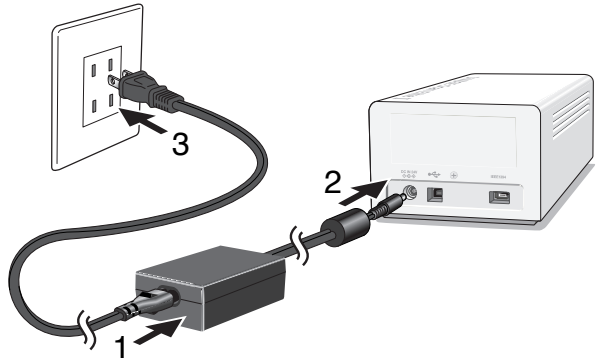

Turning on the scanner

With the front door closed, turn on the scanner with the power switch (1). Start up the computer.

When launching the DiMAGE Scan Utility, the front door must be closed during initialization; the indicator lamp will blink when the scanner is initializing. Once the indicator lamp glows steadily, the scanner can be used.

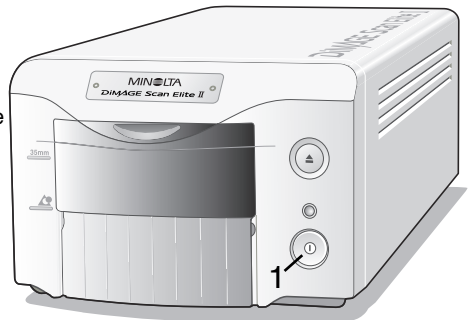

LOADING THE FILM HOLDERS

Handling film

To achieve the best possible reproduction from the scanner, the film and film holder should be free from dust and dirt. Always work with processed film in a clean, dust-free environment. Handle film by the edges or mount to prevent fingerprints and dirt marring the image area. Special lint free gloves are available from photographic equipment retailers for film handling as well as anti-static cloths, brushes, and blowers for removing dust. Film cleaner can be used to remove oil, grease, or dirt from film; carefully follow the manufacturer's instructions and precautions for the film cleaning solvent.

Where is the emulsion?

When film is scanned, the emulsion side of the film should be down. When viewing the film image, if the image is orientated correctly rather than a mirror image, the emulsion side is facing down. If the image is abstract or symmetrical so its orientation is difficult to determine, the emulsion is down if the frame numbers and edge markings can be read correctly. With mounted slides, the emulsion is on the same side of the mount as the film manufacturer's or processor's name is printed.

Loading 35mm film strips

Film strips of up to six frames can be loaded into the FH-U1 film holder. To remove the cover, lift the tab at the end of the film holder (1).

With the emulsion down, place the film on the base of the holder. Align the film with the frame apertures.

Replace the cover. Slide the two protrusions on the left side of the cover into the two slots in the base (2). Carefully lower the cover taking care not to move the film. Snap the cover closed by pressing the two push marks on each side of the tab (3).

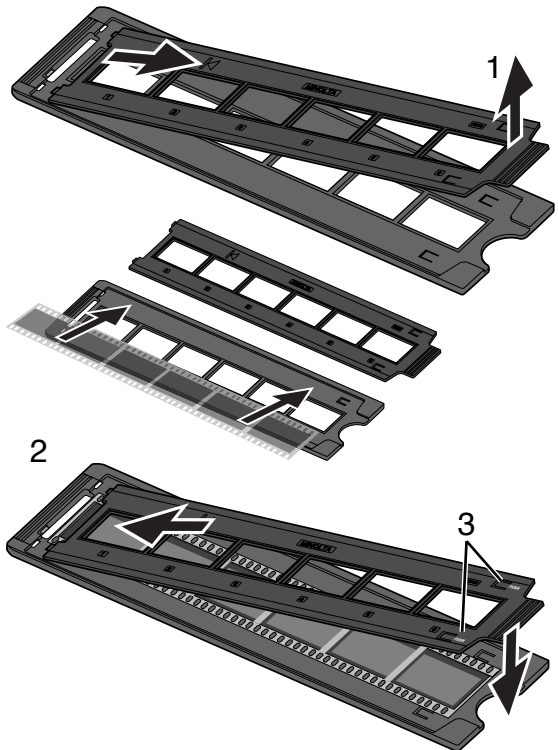

Loading mounted slides

Up to four mounted 35mm or APS slides can be inserted into the slide mount holder. The slide mounts must be between 1 mm and 2 mm thick to fit the holder. Glass mounts cannot be used; the glass refracts the light resulting in distorted and unevenly illuminated scans.

Hold the slide mount holder so that the slots are to the top and the frame numbers are upside-down and face up. Insert the slides into the holder emulsion side down. The slide must be parallel with the length of the holder otherwise the top and bottom of the image area will be cropped.

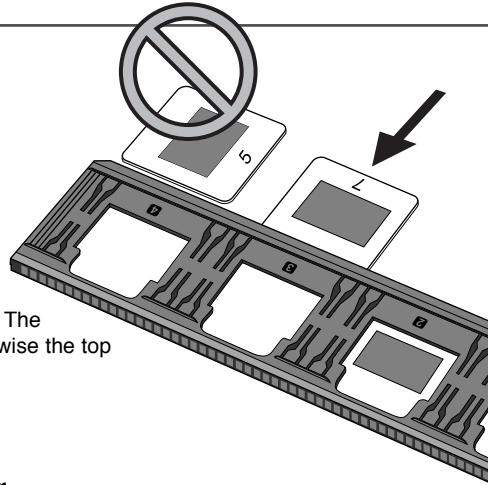

Loading a film holder into the scanner

Before using the scanner, install the DiIMAGE Scan Utility; see the software instruction manual. With the front door closed, turn on the scanner and then start the computer. Launch the DiIMAGE Scan Utility before inserting the film holder. Do not insert the film holder into the scanner while the utility software is launching or the scanner is initializing; the indicator lamp blinks during this period.

When the indicator lamp glows steadily, open the front door until the top of the door is aligned with the 35mm film-holder mark.

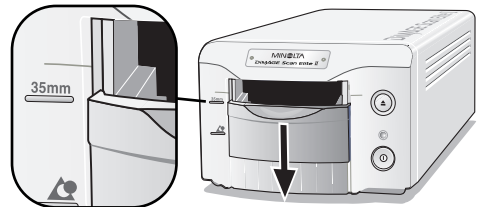

Insert the film holder into the scanner in the direction indicated by the arrow. Hold the holder straight and level when inserting it into the scanner.

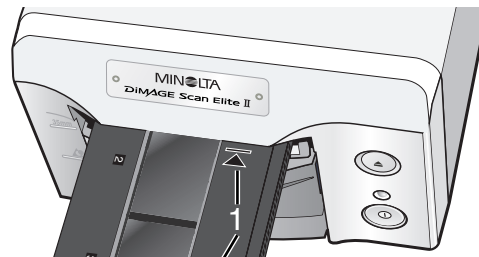

Carefully push the holder into the scanner until the arrow mark (1) is aligned with the scanner door; the holder will be automatically fed into the scanner from that point. Never touch or hinder the holder when it is in the scanner.

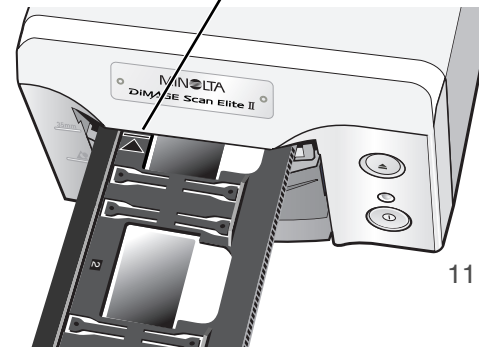

LOADING THE FILM HOLDERS

Using the APS Adapter AD-10 (sold separately)

APS (Advanced Photo System) cassette film can be scanned using the APS Adapter AD-10. The cassette must contain processed film; the square number 4 mark at the end of the cassette should be highlighted in white. Do not load unprocessed film.

To load an APS cassette, slide the film-chamber release (1) toward the top of the adapter unit until the chamber door opens (2). The film-chamber release will not return to its original position until the door is closed.

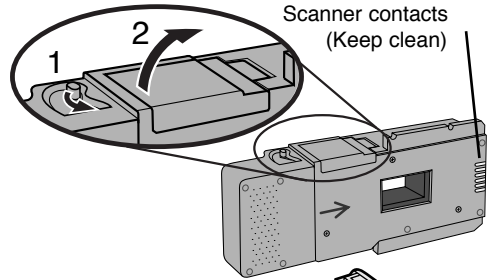

Insert the cassette into the film chamber as shown (3). Close the chamber door (4); the film-chamber release will return to its original position (5).

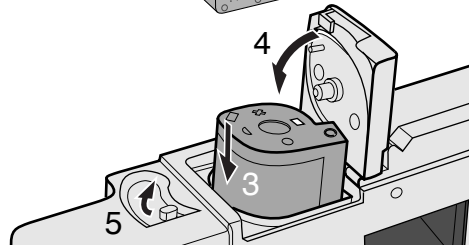

When the indicator lamp glows steadily, open the front door until the top of the door is aligned with the APS film-holder mark.

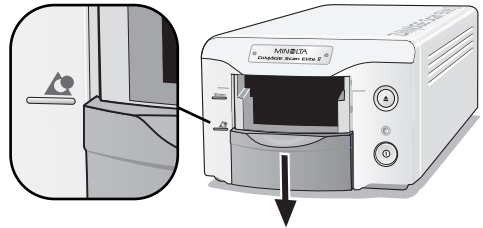

With the scanner contacts face up, insert the adapter into the scanner until it stops. The scanner detects the holder and automatically loads the film. Do not remove the holder until the film has been rewound, see page 13.

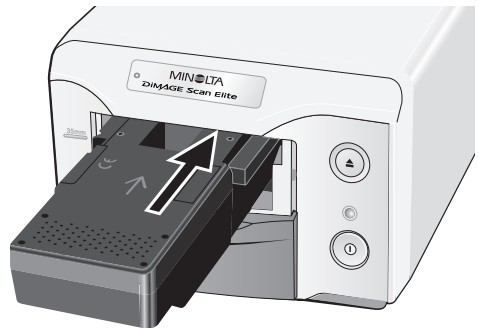

When using the APS adapter, if the scanner makes a strange sound or the film-advance warning appears, eject the APS adapter immediately (p. 13) and do not reinsert it. Contact a Minolta service facility.

Film format and type settings

When scanning, the film type and format must be selected in the main window of the DiIMAGE Scan Utility. This scanner does not use glass holders and so the holder-type drop-down menu is deselected. See scanner setup in the basic-scanning section of the software manual.

Two film formats can be selected with this scanner: 35 mm and APS. The APS option is for use with cassette film with the optional APS adapter AD-10. If scanning APS film in slide mounts, use the 35 mm film-format option.

Film type can be selected between color and black and white, positive and negative film. Film for prints is negative film. Slide film is positive film. APS has an additional option: auto-detect. Auto detect automatically sets the film type between color and black and white, and positive and negative.

When making an index scan with the optional APS holder, the thumbnail frame numbers correspond to the film frame numbers.

Ejecting a film holder

Use the eject button on the scanner body or in the DiIMAGE Scan Utility window to remove the holder; the scanner automatically ejects the holder to its initial insertion position. Do not touch or hinder the holder while it is moving.

When using the optional APS Adapter, the scanner automatically rewinds the film when the eject button is pressed. Do not remove the adapter until the rewind motor has stopped.

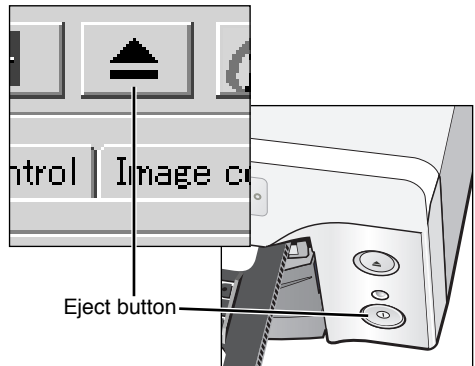

Close the front door when the scanner is not in use.

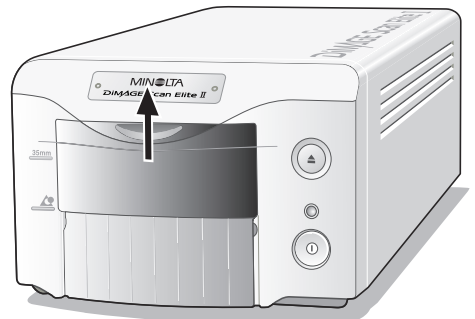

Adobe Photoshop Elements

Take time to register your copy of Photoshop Elements with Adobe. You can register online, by fax, or by mail. The software can be registered online during installation by following the instructions on the installer screens. To register by fax or mail, read the instructions in the registration folder located in the technical-information folder on the Adobe Photoshop Elements CD-ROM.

PC / AT compatible computers	Macintosh computers
Pentium processor	PowerPC processor
Windows 98, 98 Second Edition, Me, 2000, NT 4.0, or XP.	Mac OS 8.6, 9.0, 9.0.4, or 9.1.
Internet Explorer 4.0, 5.0, or 5.5.	64 MB of RAM (with virtual memory on)
64 MB of RAM	
150 MB of available hard disk space	
Color monitor with 256-color (8 bit) or greater video card and 800 X 600 or greater monitor resolution.	

The DiIMAGE Scan Utility can be opened from Photoshop Elements with the import option on the file menu. For Macintosh systems, the DiIMAGE Scan Utility plug-in module must first be installed in the Photoshop Elements import/export folder located in the plug-in folder.

Files saved with a 16-bit or 16-bit linear color depth cannot be opened in Adobe Photoshop. Refer to setting scanner preferences in the advanced scanning section in the DiIMAGE Scan Utility manual.

Easy Scan Utility

The Easy Scan Utility is compatible with this scanner. This software simplifies the scanning process for individuals with no image-processing or DTP experience, see the DiIMAGE Scan Utility manual.

About the DiIMAGE Scan Utility

Prescan size cannot be selected in the preference dialog box with this scanner model. See setting scanner preferences in the advanced scanning section of the DiIMAGE Scan Utility manual.

Digital ICE³ system requirements

Digital ICE³ is a collection of powerful image-processing tools. To make use of the Digital ROC and Gem functions, the following system requirements must be met. These requirements are based on 35mm film scans.

PC / AT compatible computers			
Color depth	Minimum system requirements		
	Hard disk space	RAM	CPU
8 bit	300MB	128MB	Pentium 166MHz or later
16 bit	500MB		
Recommended system requirements			
8 bit	600MB or more	256MB	Pentium III or later
16 bit	1GB or more		

Macintosh computers			
Color depth	Minimum system requirements		
	Hard disk space	RAM	CPU
8 bit	300MB	128MB	Power PC G3 or later
16 bit	500MB		
Recommended system requirements			
8 bit	600MB or more	256MB	Power PC G4 or later
16 bit	1GB or more		

When determining the RAM available for a Macintosh computer, the volume required for the operating system and any application in use must be subtracted from the total memory allocation of the computer.

Scanner color profiles

When the DiIMAGE Scan Utility is installed, the scanner profiles listed below are automatically installed in the color folder in Windows, and in the ColorSync profile folder in Macintosh. These profiles have been included for advanced color matching with profile-to-profile conversions in sophisticated image-processing or DTP applications. When using these profiles, the color reproduced may not be the same as the color matching system in the utility software.

MLTAF2920.icc - used with positive film at any color depth other than 16-bit linear.

MLTAF2920p.icc - used with positive film with 16-bit linear color depth.

Scanner resolution

The maximum resolution for the DiIMAGE Scan Elite II is 2820 dpi. The input resolution that can be entered in the DiIMAGE Scan Utility is from 176 dpi to the maximum resolution of 2820 dpi for both 35mm and APS film.

Disconnecting the scanner

The easiest and safest way to disconnect the scanner from the computer is to turn off both devices as well as any peripheral devices and remove the cable. However, the following procedures can be used depending on the cable and operating system employed.



Never disconnect the scanner when the indicator lamp is blinking.

Disconnecting the USB cable

Quit the DiIMAGE Scan Utility. Confirm that the scanner indicator lamp is not blinking. Turn the scanner off and then disconnect the cable.

Disconnecting the IEEE cable with 2000 professional, XP, and Macintosh

Quit the DiIMAGE Scan Utility. Confirm that the scanner indicator lamp is not blinking. Turn the scanner off and then disconnect the cable.

Disconnecting the IEEE cable with Windows ME



To disconnect the scanner, quit the DiMAGE Scan Utility. Left click on the unplug-or-eject-hardware icon located on the task bar. A small window will open indicating the device to be stopped.



Click on the small window to stop the device. The safe-to-remove-hardware window will open. Click OK. Turn the scanner off and then disconnect the cable.

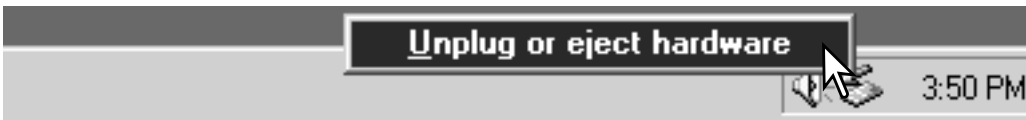

When more than one external device are connected to the computer, repeat the procedure above except right click on the unplug-or-eject-hardware icon. This will open the unplug-or-eject-hardware window after clicking on the small window indicating the unplug operation.

On the unplug-or-eject-hardware window, the hardware devices to be stopped will be displayed. Highlight the device by clicking on it then click the stop button.

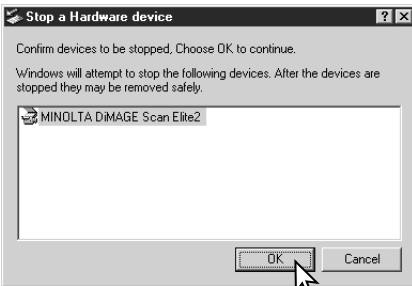
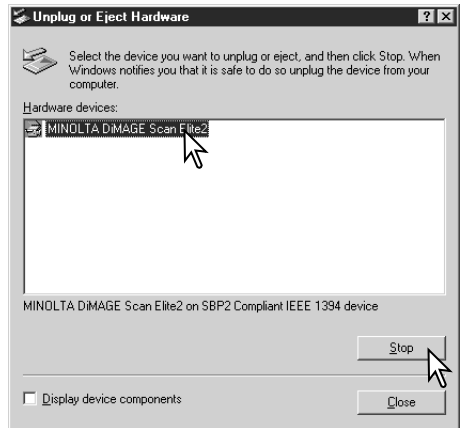

A confirmation screen will appear to indicate the devices to be stopped. Click the OK button to stop the device.

A third and final screen will appear to indicate the scanner can be safely disconnected from the computer; click OK. Turn the scanner off and then disconnect the cable.

JOB FILE LISTS

Jobs can be used to make scan settings based on the final use of the image. See making-the-final-scan section in the DiMAGE Scan Utility manual. The following charts list the parameters of the scanner's Job files:

35mm

Category	Job Name	Input Res.	Output Res.	Mag.	Unit	Input Size		Input Lock	Output Size		Output Lock
						W	H		W	H	
Default	Default	705	300	235	pixel	1008	672	OFF	1008	672	OFF
ColorLaserPrinter	A4Quarter	2602	600	433	mm	34.18	24.25	OFF	148	105	ON
	A4Eighth	1846	600	307	mm	34.2	24.27	OFF	105	74.5	ON
	LetterQuarter	2676	600	446	inch	1.22	0.95	OFF	5.45	4.25	ON
	LetterEighth	1990	600	331	inch	1.22	0.95	OFF	4.05	3.16	ON
Photosensitive	A5Full	2445	400	611	mm	34.37	24.22	OFF	210	148	ON
	LetterHalf	2378	400	594	inch	1.43	0.92	OFF	8.5	5.45	ON
	LetterQuarter	1784	400	446	inch	1.22	0.95	OFF	5.45	4.25	ON
	2L	2099	400	524	mm	33.97	24.24	OFF	178	127	ON
	PostCard4x6	1679	400	419	inch	1.43	0.95	OFF	6	4	ON
Ink-Jet & Dye-SubPrinter	A4Full	2602	300	867	mm	34.26	24.22	OFF	297	210	ON
	A4Half	1834	300	611	mm	34.37	24.22	OFF	210	148	ON
	A4Quarter	1301	300	433	mm	34.18	24.25	OFF	148	105	ON
	A4Eighth	923	300	307	mm	34.2	24.27	OFF	105	74.5	ON
	LetterFull	2676	300	892	inch	1.22	0.95	OFF	10.9	8.5	ON
	LetterHalf	1784	300	594	inch	1.43	0.92	OFF	8.5	5.45	ON
	LetterQuarter	1338	300	446	inch	1.22	0.95	OFF	5.45	4.25	ON
	LetterEighth	995	300	331	inch	1.22	0.95	OFF	4.05	3.16	ON
	Photo4x6	1239	300	413	mm	36.32	24.21	OFF	150	100	ON
	Photo3x5	1103	300	367	mm	34.61	24.25	OFF	127	89	ON
WebPage	1240x836	878	72	1219	pixel	1240	836	OFF	1240	836	ON
	1112x750	787	72	1093	pixel	1112	750	OFF	1112	750	ON
	984x663	696	72	966	pixel	984	663	OFF	984	663	ON
	792x534	561	72	779	pixel	792	534	OFF	792	534	ON
	760x512	538	72	747	pixel	760	512	OFF	760	512	ON
	600x404	424	72	588	pixel	600	404	OFF	600	404	ON
	320x240	252	72	350	pixel	320	240	OFF	320	240	ON
PhotoCD	PhotoCD2048x3072	2149	300	716	pixel	3072	2048	OFF	3072	2048	ON
	PhotoCD1024x1536	1075	300	358	pixel	1536	1024	OFF	1536	1024	ON
	PhotoCD512x768	538	300	179	pixel	768	512	OFF	768	512	ON
Screen	1920x1200	1343	72	1865	pixel	1920	1200	OFF	1920	1200	ON
	1600x1200	1259	72	1748	pixel	1600	1200	OFF	1600	1200	ON
	1280x1024	1075	72	1493	pixel	1280	1024	OFF	1280	1024	ON
	1280x960	1008	72	1400	pixel	1280	960	OFF	1280	960	ON
	1152x870	913	72	1268	pixel	1152	870	OFF	1152	870	ON
	1024x768	806	72	1119	pixel	1024	768	OFF	1024	768	ON
	832x624	655	72	909	pixel	832	624	OFF	832	624	ON
	800x600	630	72	875	pixel	800	600	OFF	800	600	ON
	640x480	504	72	700	pixel	640	480	OFF	640	480	ON
Document	A4Half	440	72	611	mm	34.37	24.22	OFF	210	148	ON
	A4Quarter	312	72	433	mm	34.18	24.25	OFF	148	105	ON
	A4Eighth	220	72	305	mm	34.43	24.26	OFF	105	74	ON
	LetterHalf	429	72	595	inch	1.43	0.92	OFF	8.5	5.45	ON
	LetterQuarter	322	72	447	inch	1.22	0.95	OFF	5.45	4.25	ON
	LetterEighth	215	72	298	inch	1.43	0.91	OFF	4.25	2.72	ON
FilmRecorder	2K	1433	2400	59	pixel	2048	1365	OFF	2048	1365	ON

APS

Category	Job Name	Input Res.	Output Res.	Mag.	Unit	Input Size		Input Lock	Output Size		Output Lock
						W	H		W	H	
Default	Default	705	300	235	pixel	832	480	OFF	832	480	OFF
ColorLaserPrinter	A4Eighth LetterEighth	2584	600	430	mm	24.42	17.33	OFF	105	74.5	ON
		2785	600	464	inch	0.87	0.68	OFF	4.05	3.16	ON
Photosensitive	A5Full LetterQuarter 2L PostCard4x6	2820	400	705	mm	29.79	17.3	OFF	210	121.95	ON
		2497	400	624	inch	0.87	0.68	OFF	5.45	4.25	ON
		2820	400	705	mm	25.25	17.3	OFF	178	121.95	ON
		2350	400	587	inch	1.02	0.68	OFF	6	4	ON
Ink-Jet & Dye-SubPrinter	A4Half A4Quarter A4Eighth LetterHalf LetterQuarter LetterEighth Photo4x6 Photo3x5	2568	300	856	mm	24.53	17.29	OFF	210	148	ON
		1822	300	607	mm	24.38	17.3	OFF	148	105	ON
		1292	300	430	mm	24.42	17.33	OFF	105	74.5	ON
		2402	300	800	inch	1.06	0.68	OFF	8.5	5.45	ON
		1873	300	624	inch	0.87	0.68	OFF	5.45	4.25	ON
		1393	300	464	inch	0.87	0.68	OFF	4.05	3.16	ON
		1735	300	578	mm	25.95	17.3	OFF	150	100	ON
1544	300	514	mm	24.71	17.32	OFF	127	89	ON		
WebPage	1240x836 1112x750 984x663 792x534 760x512 600x404 320x240	1228	72	1705	pixel	1240	836	OFF	1240	836	ON
		1102	72	1530	pixel	1112	750	OFF	1112	750	ON
		974	72	1352	pixel	984	663	OFF	984	663	ON
		785	72	1090	pixel	792	534	OFF	792	534	ON
		752	72	1044	pixel	760	512	OFF	760	512	ON
		594	72	825	pixel	600	404	OFF	600	404	ON
		353	72	490	pixel	320	240	OFF	320	240	ON
PhotoCD	PhotoCD1024x1536 PhotoCD512x768	1504	300	501	pixel	1536	1024	OFF	1536	1024	ON
		752	300	250	pixel	768	512	OFF	768	512	ON
Screen	1920x1200 1600x1200 1280x1024 1280x960 1152x870 1024x768 832x624 800x600 640x480	1763	72	2448	pixel	1920	1200	OFF	1920	1200	ON
		1763	72	2448	pixel	1600	1200	OFF	1600	1200	ON
		1504	72	2088	pixel	1280	1024	OFF	1280	1024	ON
		1410	72	1958	pixel	1280	960	OFF	1280	960	ON
		1278	72	1775	pixel	1152	870	OFF	1152	870	ON
		1128	72	1566	pixel	1024	768	OFF	1024	768	ON
		917	72	1273	pixel	832	624	OFF	832	624	ON
		882	72	1225	pixel	800	600	OFF	800	600	ON
		705	72	979	pixel	640	480	OFF	640	480	ON
Document	A4Half A4Quarter A4Eighth LetterHalf LetterQuarter LetterEighth	616	72	855	mm	24.56	17.31	OFF	210	148	ON
		437	72	606	mm	24.42	17.33	OFF	148	105	ON
		307	72	426	mm	24.65	17.37	OFF	105	74	ON
		576	72	800	inch	1.06	0.68	OFF	8.5	5.45	ON
		450	72	625	inch	0.87	0.68	OFF	5.45	4.25	ON
		287	72	398	inch	1.07	0.68	OFF	4.25	2.72	ON
FilmRecorder	2K	2005	2400	83	pixel	2048	1365	OFF	2048	1365	ON

TROUBLESHOOTING

This section covers minor problems with scanner operation. For major problems or damage, or if a problem continues to reoccur frequently, contact your dealer or a Minolta service facility.

SYMPTOM or MESSAGE	SOLUTION
When starting up the utility software, Error=4 – could-not-confirm-scanner-connection message appears.	Confirm the cable is securely connected between the computer and scanner. Turn the scanner off and on. Click OK to continue.
When starting up the utility software, Error=42 – close-scanner-door message appears.	Close the scanner door. Click OK to continue.
<ul style="list-style-type: none"> • The utility software freezes. • The scanning time increases. 	Turn off the scanner. Shut down the image-processing application and increase its memory allocation. Restart the computer and scanner.
Unusual image color when scanning color negative film.	Confirm color negative film is selected in the main window, and rescan the image, or color balance the image using the DiMAGE Scan's image-processing tools. If the problem is not solved, reinstall the DiMAGE Scan Utility.
The scanned image is not sharp.	Select an autofocus option in the preference box, or use point AF or manual focus.
Cannot-verify-home-position message appears during scanning.	The film holder was hindered during the scan. Turn off the scanner, and restart the computer.
Cannot scan APS film, and initial loading failed. The error-during-film-transportation or error-during-rewind message appears.	Press the eject button on the scanner, and remove the APS adapter after rewinding is completed. Reinsert the holder into the scanner and make the scan again.
The scanner indicator lamp blinks rapidly.	The scanner door was opened during setup. Close the door, and shut down and restart the scanner and DiMAGE Scan Utility.
The set-holder message appears.	Reload the holder into the scanner.
The holder-does-not-match-selected-film message appears.	Set the correct film format in the DiMAGE Scan Utility or insert the correct holder into the scanner.
The film-not-found-in-APS-holder message appears.	Insert an APS cassette into the APS adapter.
The insufficient-memory message appears.	Increase the memory requirements for the host application. If multiple images have been scanned, close and relaunch the host application.
The DiMAGE Scan preview image displays unusual color reproduction.	Remove the film holder and close the scanner door. Press shift+control+I (Windows) or command+control+I (Macintosh) to initialize the scanner.

Checking software installation – Windows

If the scanner was connected to the computer before the DiIMAGE Scan Utility was installed, the computer may not recognize the scanner unit. Windows 2000 Professional, and XP users should log on with the administrator privilege. With Windows 2000 Professional and XP, the “Digital signatures not found” message may appear when the computer first detects the scanner. The additional message “Installing hardware...Window log test is not passed” may appear when Windows XP is launched. Simply click the OK (2000) or continue button (XP).

1. Turn off the computer and disconnect the scanner. Restart the computer.
2. **Windows 98, 2000, Me:** right click on the My-computer icon. Select “properties” from the drop-down menu.
Windows XP: from the start menu go to the control panel. Click on the performance and maintenance category. Click the system button to open the system properties window.
3. **Windows 2000 and XP:** select the hardware tab in the properties window and click the device-manager button.
Windows 98 and Me: click the device-manager tab in the properties window.
4. The driver file should be located in the imaging-device location of the device manager. Click on the location to display the files. When using a USB interface, DS_Elite2 should be listed as the imaging device. When using an IEEE interface, MINOLTA DS_Elite2 IEEE 1394 SBP2 Device should be listed as the imaging device.

If these files are not located in the imaging-device location, open the other-devices location of the device manager. If DS_Elite2 or MINOLTA DS_Elite2 IEEE 1394 SBP2 Device is listed, follow steps 5 through 9 to delete and reinstall the correct driver.
5. Click on the driver to select it for deletion.
6. **Windows 2000 and XP:** click on the action button to display the drop-down menu. Select uninstall. A confirmation screen will appear. Clicking the yes button will remove the driver from the system.
Windows 98 and Me: click the remove button. A confirmation screen will appear. Clicking the yes button will remove the driver from the system.
7. Restart the computer.
8. Install the DiIMAGE Scan Utility software; refer to the software manual.
9. Turn off the computer and reconnect the scanner.

Technical support

Please contact your dealer for information regarding installation, USB or IEEE 1394 interface recommendations, or application compatibility. If your dealer is unable to help you, contact an authorized Minolta service facility. Please have the following information ready when calling Minolta technical support:

1. The name and model of your computer.
2. The available application RAM.
3. Other connected IEEE 1394 or USB devices.
4. DiIMAGE Scan Utility version number. The version number is displayed by placing the mouse pointer on the status bar in the main window.
5. A description of the problem.
6. Any message that appears on the screen when the problem occurs.
7. The frequency of occurrence.

Warranty and product registration

Please take the time to fill in the warranty and product registration card. Technical support, scanner software upgrades, and product information is available when the product is registered.

Minolta History

On February 20th, 1962, John Glenn became the first American to orbit the Earth. On board his Friendship 7 spacecraft was a Minolta Hi-matic camera to record that historic event. The 4 hour, 55 minute, and 23 second flight orbited the Earth three times at an average speed of 28,000 kph (17,500 mph).

Mr. Glenn visited our Sakai camera factory in Japan on May 24th, 1963 to plant a palm tree to celebrate the occasion. The palm tree is still in the courtyard of the factory and stands over eight meters tall (26ft).

The camera? It was not lost. It is on display at the Smithsonian Institution's National Air and Space Museum in Washington D.C. This and other objects from John Glenn's Friendship 7 Mercury flight can be found in galley 210, "Apollo to the Moon."



TECHNICAL SPECIFICATIONS

Scan type:	Moving film, fixed sensor, single-pass scan
Film type:	Negative and positive, color and monochrome
Film formats:	Mounted and unmounted 35mm film. Mounted APS film. APS cassette with optional AD-10 adapter.
Scanning dimensions:	35mm - 24.21 x 36.32mm (2688 x 4032 pixels) APS - 17.29 x 29.98mm (1920 x 3328 pixels)
Optical input resolution:	2820 dpi
Image sensor:	3-line color CCD with 2700 pixels/line
A/D conversion:	16 bit
Color depth:	8 bit and 16 bit per color channel
Dynamic range:	4.8
Light source:	Cold cathode fluorescent tube
Focusing:	Autofocus, point AF, and manual focus
Other:	Digital ICE ³ image processing
Interface:	IEEE 1394 and USB 1.1
Power consumption:	Max. 15 W
Dimensions (W x H x D):	14.5 x 10.0 x 32.5 cm 5.7 X 3.9 X 12.8 in
Weight (approx.):	1.5 kg / 3.3 lb
Operating environment:	10° - 35°C (50° - 95°F), 15-80% humidity without condensation
Storage environment:	-20° - 60°C (-4° - 140°F), 15-80% humidity without condensation
Scan times (approx.):	35mm color positive film

Prescan: 6 sec. (Windows), 7 sec. (Macintosh)
Scan: 32 sec.

Test conditions:

Windows	Macintosh
Pentium IV 1.8GHz	PowerPC G4 533 MHz
Windows 2000 Professional	Mac OS 9.2.2
RAM: 512 MB	
IEEE 1395 with Adaptec FireConnect 4300	FireWire
Host application: Adobe Photoshop ver. 7.0	
Auto exposure: off	
Digital ICE ³ : off	

Scanning time changes according to the preferences used.
Scanning time can be longer for negative film than positive film.

Specifications are based on the latest information available at the time of printing and are subject to change without notice.

MINOLTA

© 2002 Minolta Co., Ltd. under the Berne Convention
and the Universal Copyright Convention.

0-43325-53112-5

9222-2888-11 AV-A207

Printed in Germany