

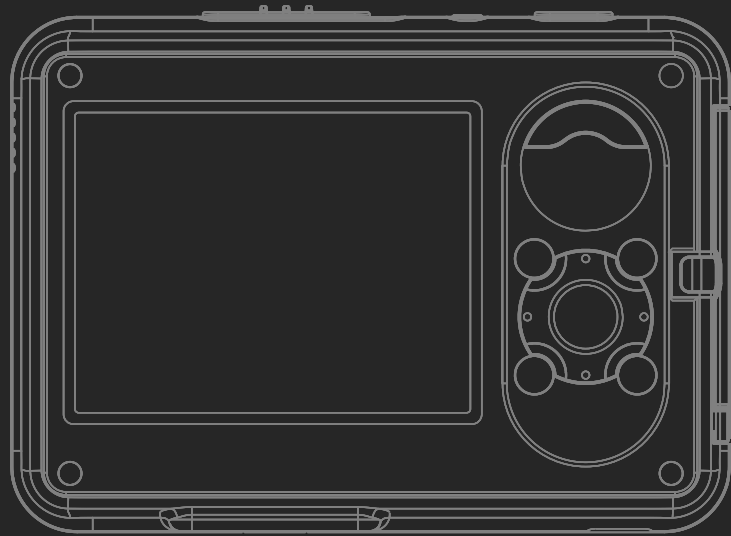

KONICA MINOLTA

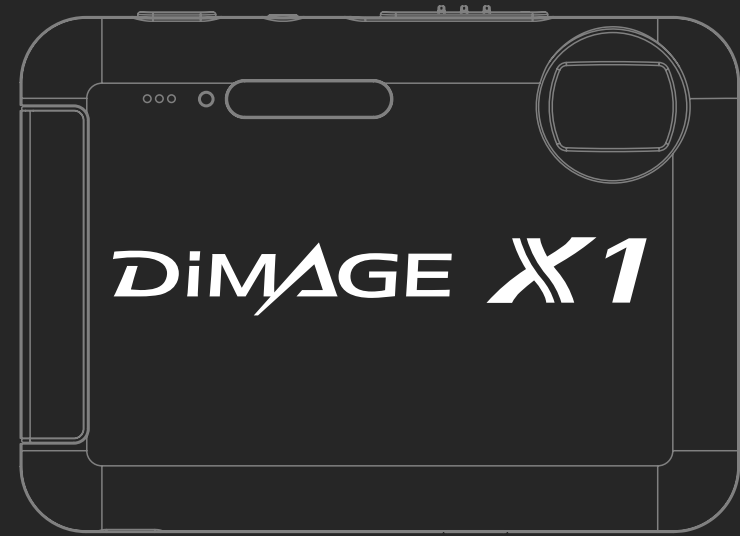

KONICA MINOLTA



**KONICA MINOLTA PHOTO IMAGING, INC.**

© 2005 Konica Minolta Photo Imaging, Inc. under the Berne  
Convention and the Universal Copyright Convention.

9979-2801-50/12984 Printed in Germany

**INSTRUCTION MANUAL**

Become a member of Konica Minolta Photo World today, free of charge, and enter the fascinating world of Konica Minolta photography.

The ultimate gateway to knowledge for photo-fans:  
**[www.KonicaMinoltaPhotoWorld.com](http://www.KonicaMinoltaPhotoWorld.com)**

Register now, save 29.99 EUR, get DiIMAGE Messenger for free!



**[www.konicaminoltasupport.com](http://www.konicaminoltasupport.com)**

**Konica Minolta Product Support Site, featuring access to a searchable Knowledgebase, Software and Hardware FAQs (Frequently Asked Questions), Software, Driver and Firmware Downloads, Telephone Support Information.**

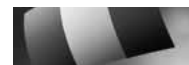

Le site d'assistance Produits Konica Minolta comporte un accès à une base de données de recherche, des Questions/Réponses relatives aux matériels et aux logiciels, des logiciels, des pilotes et des mises à jour de firmware à télécharger ainsi que des renseignements sur les possibilités d'assistance téléphonique.



Die Konica-Minolta-Support-Seite ermöglicht Ihnen den Zugriff auf eine umfangreiche Wissensdatenbank. Eine Suchfunktion gibt Ihnen Antworten auf häufig gestellte Fragen zu Hardware und Software. Aktuelle Software, Treiber und Firmware finden Sie hier ebenso wie die Telefonnummern zu unseren Support-Mitarbeitern.

## BEFORE YOU BEGIN

Thank you for purchasing this product. Please take the time to read through this instruction manual so you can enjoy all the features of your new digital camera.

Check the packing list before using this product. If any items are missing, immediately contact your camera dealer.

DiMAGE X1 digital camera  
Lithium-ion battery NP-1  
Cradle CA-1  
Hand strap HS-DG150  
USB cable USB-3  
AV cable AVC-700  
SD Memory Card  
Digital Camera Software CD-ROM  
DiMAGE Master Lite instruction manual CD-ROM  
Camera manual  
Warranty card

Only use the battery specified in this manual that are manufactured and distributed by Konica Minolta. Beware of counterfeit batteries; the use of these batteries will damage the product and may cause fire.

While reasonable efforts have been made to assure the accuracy of this information, Konica Minolta assumes no liability or responsibility for any errors or omissions of this instruction manual.

Konica Minolta is a trademark of Konica Minolta Holdings, Inc. DiMAGE is a trademark of Konica Minolta Photo Imaging, Inc. Apple, Macintosh, and Mac OS are registered trademarks of Apple Computer Inc. QuickTime and the Quick Time logo are trademarks or registered trademarks of Apple Computer, Inc., used under license. Microsoft, Windows, and Windows XP are registered trademarks or trademarks of Microsoft Corporation in the United States and other countries. The official name of Windows is Microsoft Windows Operating System. Pentium is a registered trademark of the Intel Corporation. EasyShare is a registered trademark or trademark of Eastman Kodak Company in the United States and other countries. All other brand and product names are trademarks or registered trademarks of their respective owners.

## FOR PROPER AND SAFE USE

### Lithium-ion batteries

This camera operates on a small, but powerful lithium-ion battery. Misuse or abuse of the lithium-ion battery can cause damage or injury through fire, electric shock, or chemical leakage. Read and understand all warnings before using the battery.

### DANGER

- Do not short, disassemble, damage, or modify the battery.
- Do not expose the battery to fire or high temperatures over 60°C (140°F).
- Do not expose the battery to water, or moisture. Water can corrode or damage the internal battery safety devices and cause the battery to overheat, ignite, rupture, or leak.
- Do not drop or subject the battery to strong impacts. Impacts can damage the internal battery safety devices and cause the battery to overheat, ignite, rupture, or leak.
- Do not store the battery near or in metallic products.
- Do not use the battery with any other products.
- Only use the specified cradle. An inappropriate cradle may cause damage or injury through fire or electric shock.
- Do not use a leaking battery. If fluid from the battery enters your eye, immediately rinse the eye with plenty of fresh water and contact a doctor. If fluid from the battery makes contact with your skin or clothing, wash the area thoroughly with water.
- Only use or charge the battery in an environment with ambient temperatures between 0° and 45°C (32° and 113°F). Only store the battery in an environment with ambient temperatures between -20° and 50°C (-4° and 122°F) and a humidity of 45% to 85% RH.

### WARNING

- Tape over the lithium-ion battery contacts to avoid short-circuiting during disposal; always follow local regulations for battery disposal.
- If charging is not completed after the specified period elapses, unplug the cradle and discontinue charging immediately.

## GENERAL WARNINGS AND CAUTIONS

Read and understand the following warnings and cautions for safe use of the digital camera and its accessories.

### WARNING

- Only use the battery specified in this manual.
- Only charge the battery specified in this manual with the supplied cradle.
- Only use the specified cradle or AC adapter within the voltage range indicated on the unit. An inappropriate adapter or current may cause damage or injury through fire or electric shock.
- Only use the cradle power cord in the sales region for which it was designed. An inappropriate current may cause damage or injury through fire or electric shock.
- Do not disassemble the camera or cradle. Electric shock may cause injury if a high voltage circuit inside the product is touched.
- Immediately remove the battery or unplug the AC adapter and discontinue use if the camera is dropped or subjected to an impact in which the interior, especially the flash unit, is exposed. The flash has a high voltage circuit which may cause an electric shock resulting in injury. The continued use of a damaged product or part may cause injuries or fire.
- Keep the battery, memory card, or small parts that could be swallowed away from infants. Contact a doctor immediately if an object is swallowed.
- Store this product out of reach of children. Be careful when around children not to harm them with the product or parts.
- Do not fire the flash directly into the eyes. It may damage eyesight.
- Do not fire the flash at vehicle operators. It may cause a distraction or temporary blindness which may lead to an accident.
- Do not use the monitor while operating a vehicle or walking. It may result in injury or an accident.
- Do not use these products in a humid environment, or operate them with wet hands. If liquid enters these products, immediately remove the battery or unplug the product, and discontinue use. The continued use of a product exposed to liquids may cause damage or injury through fire or electric shock.

- Do not use these products near inflammable gases or liquids such as gasoline, benzene, or paint thinner. Do not use inflammable products such as alcohol, benzene, or paint thinner to clean these products. The use of inflammable cleaners and solvents may cause an explosion or fire.
- When unplugging the AC adapter or cradle, do not pull on the power cord. Hold the plug when removing it from an outlet.
- Do not damage, twist, modify, heat, or place heavy objects on the AC adapter or cradle cord. A damaged cord may cause damage or injury through fire or electric shock.
- If these products emits a strange odor, heat, or smoke, discontinue use. Immediately remove the battery taking care not to burn yourself as the battery may become hot with use. The continued use of a damaged product or part may cause injuries or fire.
- Take the product to a Konica Minolta service facility when repairs are required.

## CAUTION

- Do not use or store these products in a hot or humid environment such as the glove compartment or trunk of a car. It may damage the camera, cradle, and battery which may result in burns or injuries caused by heat, fire, explosion, or leaking battery fluid.
- If the battery is leaking, discontinue use of the product.
- The camera, cradle, and battery temperature rises with extended periods of use. Care should be taken to avoid burns.
- Burns may result if the memory card or battery is removed immediately after extended periods of use. Turn the camera off and wait for it to cool.
- Do not fire the flash while it is in contact with people or objects. The flash unit discharges a large amount of energy which may cause burns.
- Do not apply pressure to the LCD monitor. A damaged monitor may cause injury, and the liquid from the monitor may cause inflammation. If liquid from the monitor makes contact with skin, wash the area with fresh water. If liquid from the monitor comes in contact with the eyes, immediately rinse the eyes with plenty of water and contact a doctor.
- When using the AC adapter and cradle, insert the plug securely into the electrical outlet.
- Do not use electronic transformers or travel adapters with the cradle. The use of these devices may cause a fire or damage the product.
- Do not use if the AC adapter or cradle cord is damaged.
- Do not cover the AC adapter or cradle. A fire may result.
- Do not obstruct access to the AC adapter or cradle; this can hinder the unplugging of the units in emergencies.
- Unplug the AC adapter or cradle when cleaning or not in use.

The following marks may be found on the product:

 This mark on your camera certifies that this camera meets the requirements of the EU (European Union) concerning interference causing equipment regulations. CE stands for Conformité Européenne (European Conformity).

This Class B digital apparatus complies with Canadian ICES-003.

FCC Compliance Statement  
Declaration on Conformity

Responsible Party: Konica Minolta Photo Imaging USA Inc.  
Address: 725 Darlington Avenue, Mahwah, NJ 07430

Digital Camera: DiIMAGE X1

 Tested To Comply  
With FCC Standards

FOR HOME OR OFFICE USE

This device complies with Part 15 of the FCC Rules. Operation is subject to the following two conditions: (1) This device may not cause harmful interference, and (2) this device must accept any interference received, including interference that may cause undesired operation. Changes or modifications not approved by the party responsible for compliance could void the user's authority to operate the equipment.

This equipment has been tested and found to comply with the limits for a Class B digital device, pursuant to Part 15 of the FCC Rules. These limits are designed to provide reasonable protection against harmful interference in a residential installation. This equipment generates, uses and can radiate radio frequency energy and, if not installed and used in accordance with the instructions, may cause harmful interference to radio communications. However, there is no guarantee that interference will not occur in a particular installation. If this equipment does cause harmful interference to radio or television reception, which can be determined by turning the equipment off and on, the user is encouraged to try to correct the interference by one or more of the following measures:

- Reorient or relocate the receiving antenna.
- Increase the separation between the equipment and the receiver.
- Connect the equipment to an outlet on a circuit different from that to which the receiver is connected.
- Consult the dealer or an experienced radio/TV technician for help.

Do not remove the ferrite cores from the cables.

## TABLE OF CONTENTS

The getting up and running section covers how to prepare the camera for use. It contains important information about power supplies and memory cards. The basic operation of this camera is covered in the recording - basic operation section between pages 23 and 32, and the playback - basic operation section between pages 33 and 36. Read the data-transfer mode section in its entirety before connecting the camera to a computer.

Many of the features of this camera are controlled with menus. The menu navigation sections concisely describe how to change menu settings. Descriptions of the settings immediately follow the navigation sections.

The appendix contains a troubleshooting section to help answer questions about the operation of the camera. Information covering camera care and storage is also provided. Please store this manual in a safe place.

Names of parts .....	12
Getting up and running .....	14
Attaching the strap .....	14
Charging the battery .....	15
Inserting the battery .....	16
Charging the battery in the camera .....	17
Battery-condition indicator .....	18
Auto power save .....	18
AC adapter (sold separately) .....	19
Installing and removing a memory card .....	20
Turning the camera on .....	21
Setting the date and time .....	22
Recording mode - basic operation .....	23
Handling the camera .....	23
Setting the camera to record images .....	23
LCD monitor display .....	24
Using the zoom lens .....	24
Basic recording operation .....	25
Focus lock .....	26
Focus range .....	26
Focus signals .....	27

Special focusing situations .....	27
Flash modes .....	28
Flash range - Automatic operation .....	29
Flash signals .....	29
Display button - recording mode .....	30
Camera-shake warning .....	30
Digital subject programs .....	31
Spot AF .....	32
Playback - basic operation .....	33
Single-frame playback display .....	33
Rotating images .....	34
Deleting single images .....	34
Display button - playback mode .....	34
Enlarged playback .....	35
Index playback .....	36
Playback on the cradle .....	36
Recording - advanced operation .....	37
Movie recording .....	37
Navigating the recording menus .....	38
Drive modes .....	40
Self-timer .....	40
Continuous advance .....	41
Advanced modes .....	42
UHS continuous advance .....	42
Progressive Capture .....	43
UHS progressive Capture .....	43
Multi frame .....	44
Image size and image quality .....	44
White balance .....	46
Anti-Shake system .....	47
Camera sensitivity - ISO .....	48
Flash range and camera sensitivity .....	49
Metering modes .....	49
Exposure compensation .....	50
Instant playback .....	51
Hibright LCD .....	52
Color mode .....	52
Sharpness .....	53
Contrast .....	54
Digital zoom .....	55

Date imprinting .....	56	Viewing images on a television .....	81
Custom key function .....	57	Transfer mode .....	82
Recording mode .....	58	Firmware version .....	82
Audio recording .....	58	Data-transfer mode .....	83
Movie image sizes .....	59	System requirements .....	83
Movie file sizes .....	59	Connecting the camera to a computer .....	84
Optical zoom .....	59	Connecting to Windows 98 and 98SE .....	85
Movie focus mode .....	60	Automatic installation .....	85
Movie mode .....	60	Manual installation .....	86
Movie audio .....	60	Folder organization .....	88
Playback - advanced operation .....	61	Disconnecting the camera from the computer .....	90
Playing back movies and audio recordings .....	61	Windows 98 / 98 Second Edition .....	90
Navigating the playback menu .....	62	Windows XP, 2000 Professional, and Me .....	90
Deleting image and audio files .....	64	Macintosh .....	91
Formatting memory cards .....	65	Changing the memory card - data-transfer mode .....	92
Audio caption .....	66	Auto power save - data transfer mode .....	92
Locking files .....	67	Removing the driver software - Windows .....	93
Slide show .....	68	PictBridge .....	94
Dissolve .....	68	Notes on printing errors .....	95
Crop frame .....	69	Navigating the PictBridge menu .....	96
About DPOF .....	70	Kodak EasyShare software .....	100
DPOF setup .....	70	DiMAGE Master Lite .....	102
Date print .....	71	QuickTime system requirements .....	104
Index print .....	71	Appendix .....	104
E-mail copy .....	72	Troubleshooting .....	104
Setup mode .....	73	About the cradle cord .....	106
Navigating the setup menu .....	73	Care and storage .....	106
LCD monitor brightness .....	75	Camera care .....	106
Auto reset .....	76	Cleaning .....	107
Language .....	76	Storage .....	107
Audio signals .....	77	Batteries .....	107
Focus signal .....	77	Memory cards .....	108
Shutter FX .....	77	Before important events and journeys .....	108
Volume .....	77	Operating temperatures and conditions .....	109
Auto power save .....	77	LCD monitor care .....	109
Reset default .....	78	Copyright .....	109
File number (#) memory .....	79	Questions and service .....	109
Folder Name .....	80	Technical specifications .....	110
Date and time .....	80		
Video output .....	80		

## NAMES OF PARTS

\* This camera is a sophisticated optical instrument. Care should be taken to keep these surfaces clean. Please read the care and storage instructions in the back of this manual (p. 106).

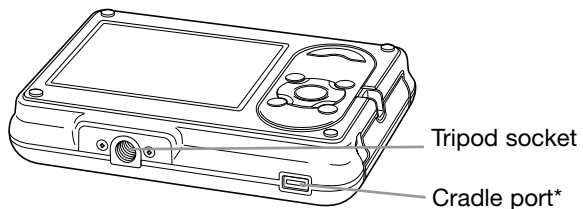
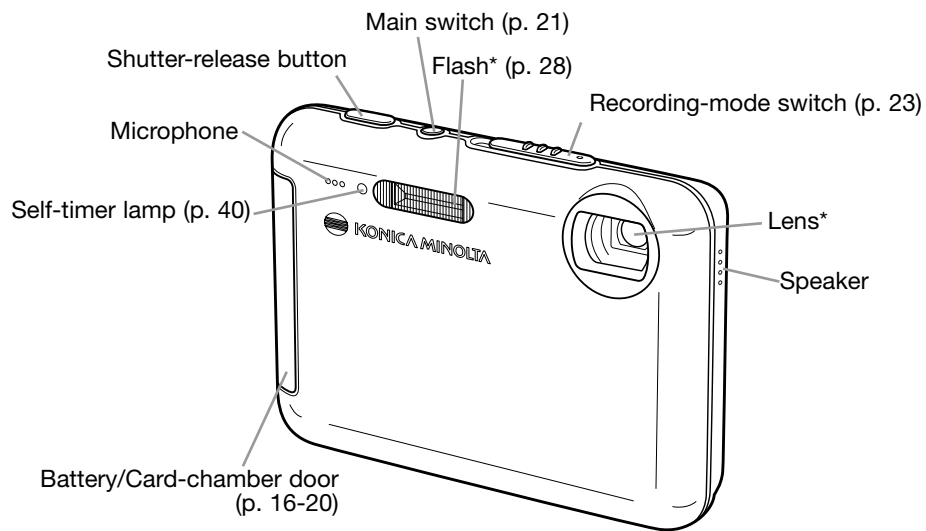

\*\* Appears during operation.

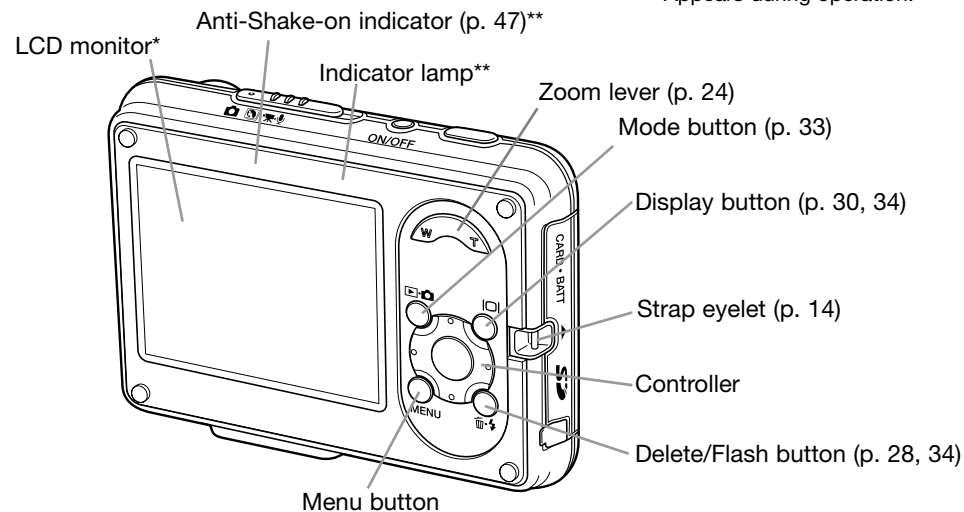

### Cradle

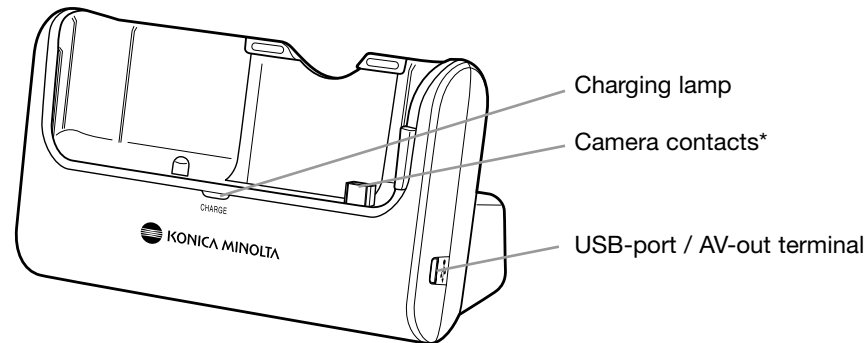



## GETTING UP AND RUNNING

### ATTACHING THE STRAP

Always keep the strap around your wrist in the event that the camera is accidentally dropped.

1. Pass the small loop of the strap through the strap eyelet on the camera body.
2. Pass the other end of the strap through the small loop and tighten.

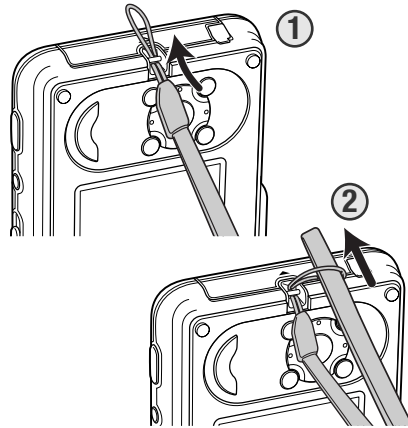

### CHARGING THE BATTERY

Before the camera can be used, the lithium-ion battery must be charged. Before charging the battery, read the safety warnings on page 3 of this manual. Battery can be charged with or without the camera; see page 17 for charging the battery in the camera. Only recharge the battery with the supplied cradle. The battery should be recharged before each shooting session. See page 107 for battery care and storage.

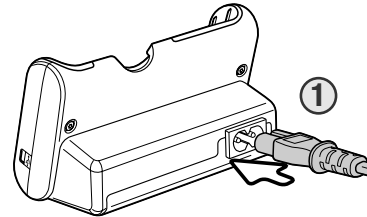

Plug the power cord into the back of the cradle (1). Plug the other end of the cord into a live household outlet. The included AC cord is designed for the current of the sales region. Only use the cord in the region it was purchased. For more on the AC cable, see page 106.

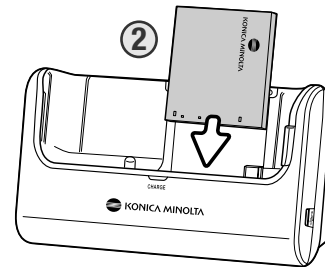

With the battery terminals down, slide the battery into the back of the cradle until the tabs in the battery slot catch the top of the battery (2). The printing on the battery should be visible when inserted in the cradle.

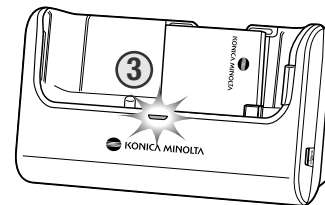

The charging lamp (3) glows to show the battery is charging. The lamp goes out when the battery has been charged. Charging time is approximately two hours. Remove the battery from the cradle. Unplug the power cord from the outlet.

## INSERTING THE BATTERY

This digital camera uses one NP-1 lithium-ion battery. Before using the battery, read the safety warnings on page 3 of this manual. When replacing the battery, the camera should be turned off (p. 21).

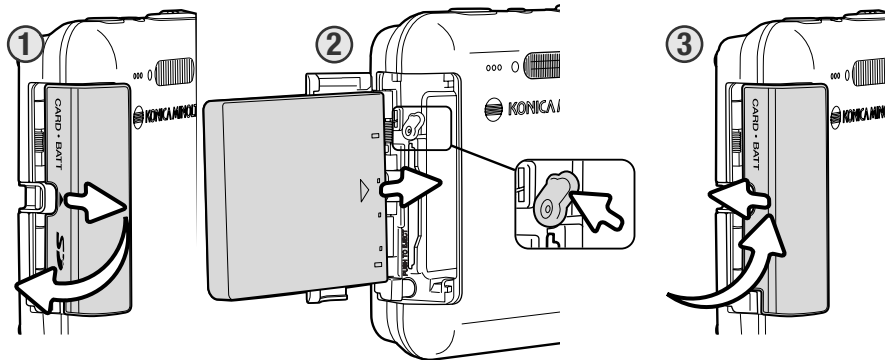

1. Slide the battery-chamber door toward the front of the camera to release the safety catch; the door springs open.
2. Move the battery latch towards the back of the camera to insert the battery. With the battery terminal first and the printing toward the front of the camera, slide the battery into the battery chamber until it is caught by the latch.  
  
To remove the battery, slide the latch towards the back of the camera until the battery is released. Pull the battery out of the chamber.
3. Close the battery-chamber door and slide it toward the back of the camera to engage the safety catch.

After installing the battery, the set-time/date message may appear on the monitor, see page 22 on how to set up the clock and calendar.

## CHARGING THE BATTERY IN THE CAMERA

Battery can be charged without removing it from the camera.

1. Insert the battery to the camera (p. 16).
2. Plug the power cord into the cradle and a live household outlet (p. 15).

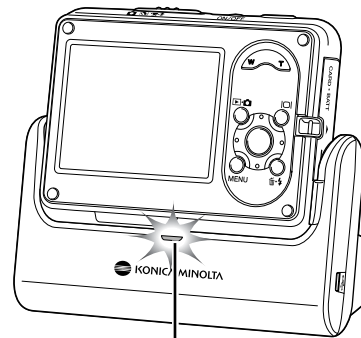

Charging lamp

3. Turn the camera off and place it in the cradle with LCD monitor facing forward. The charging lamp glows to show the battery is charging. The lamp goes out when the battery has been charged. Charging time is approximately two hours.
4. When the charging lamp goes out, remove the camera from the cradle first, then unplug the power cord.

The camera must be off when inserting it into the cradle, otherwise the battery will not charge. If the charging lamp blinks, confirm a battery is in the camera.

Keep cradle terminal clean. Dirty terminals may prevent charging.

## BATTERY-CONDITION INDICATOR

This camera is equipped with an automatic battery-condition indicator displayed on the LCD monitor. The indicator changes from white to red when battery power is low.



**Full-battery indicator** - the battery is fully charged. This indicator is displayed when the camera is on.



**Low-battery indicator** - the battery is partially charged.



**Low-battery warning** - battery power is very low. The battery should be replaced as soon as possible. This warning automatically appears and remains on the monitor until the battery is recharged. LCD monitor turns off while the flash is charging. Some functions such as movie recording are not available.

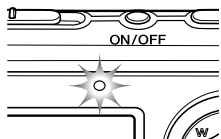

If power is insufficient for camera operation, the indicator lamp above the LCD monitor blinks for three seconds when the camera is turned on, or the battery-exhausted message appears on the LCD monitor just before the camera shuts down. The shutter will not release. The battery must be recharged.

## AUTO POWER SAVE

To conserve battery power, the camera shuts down if an operation is not made within three minutes. To restore power, press any button. The length of the auto-power-save period can be changed in section 2 of the setup menu (p. 73). When the camera is connected to a computer or PictBridge printer, the auto-power-save period is set to ten minutes and cannot be changed.

## AC ADAPTER (SOLD SEPARATELY)



Always turn off the camera before changing between power supplies.

The AC adapter AC-4 or AC-5 allows the camera to be powered from a household outlet. The AC adapter is recommended during periods of heavy use. AC adapter model AC-4 is for use in North America, Japan, and Taiwan, and AC-5 is for use in all other areas. The battery cannot be charged using the AC adapter.

To use the AC Adapter AC-4 or AC-5 with this camera, DC Adapter DA-200 is required. DC Adapter DA-200 is included in the AC Adapter Set AC-402/502.

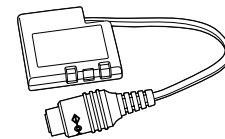

DC Adapter DA-200

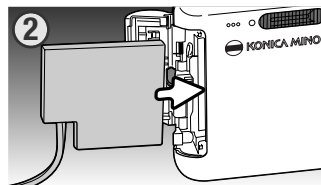

1. Open the battery-chamber door.

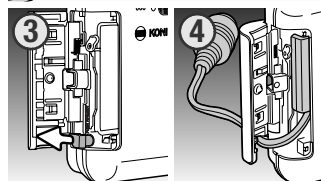

2. Move the battery latch towards the back of the camera to insert the DC plug. Slide the DC plug into the battery chamber with the terminals first until it is caught by the latch.

3. Open the cover on the side of the battery chamber.

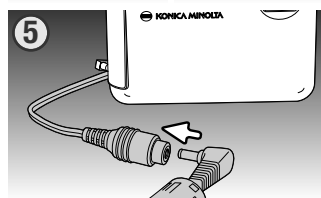

4. Place the DC adapter cable in the notch in the battery-chamber door and close the battery-chamber door.

5. Insert the mini-plug of the AC adapter into the AC socket of the DC adapter.

6. Insert the AC adapter plug into an electrical outlet.

Do not place the camera on the cradle with the DC Adapter inserted; it will damage the camera.

## INSTALLING AND REMOVING A MEMORY CARD

An SD Memory Card or MultiMediaCard must be inserted for the camera to operate. If a card has not been inserted, a no-card warning is displayed on the monitor. For more about memory cards, see page 108.



Always turn off the camera and confirm the indicator lamp is not lit before changing the memory card, otherwise the card may be damaged, and data lost.

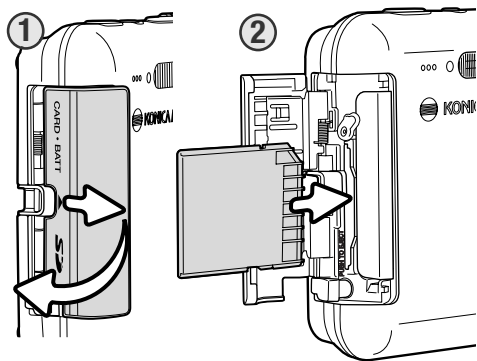

1. Slide the card-chamber door toward the front of the camera to release the safety catch; the door springs open.

2. Insert the memory card all the way into the card slot and then release. The card should catch in the slot.

Insert the card so the face is toward the back of the camera. Always push the card in straight, never at an angle. Never force the card. If the card does not fit, check that it is orientated correctly. If a MultiMediaCard is inserted incorrectly, it will lock, but the card chamber door will not close.

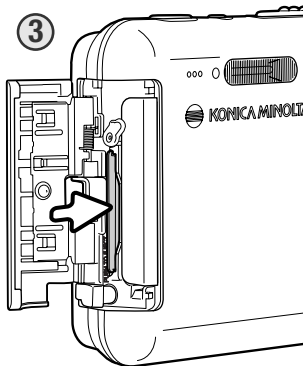

3. To eject a memory card, press the card into the slot and release. The card can now be pulled out.

4. Close the card-chamber door and slide it toward the camera to engage the safety catch.

Images can be taken without a card. Depending on the file size, one or more images can be stored temporarily and played back once. These images cannot be transferred or saved.

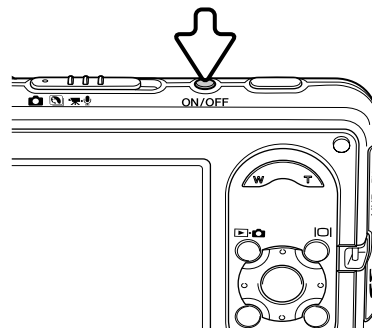

## TURNING THE CAMERA ON

To turn the camera on, press the main switch. When the camera is initially turned on, the date and time need to be set, see the following page.

Press the main switch again to turn off the camera. Always store and transport the camera off.

## SETTING THE DATE AND TIME

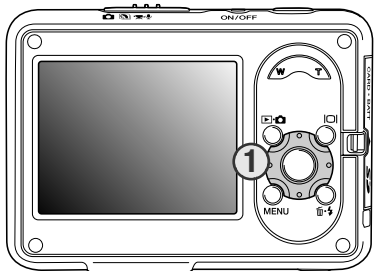

After initially inserting a memory card and a battery, the camera's clock and calendar must be set. When images are recorded, the image data is saved with the date and time of recording.

If the clock and calendar have not been set, a message may be displayed for a few seconds each time the camera is turned on. This message is also displayed if the clock and calendar reset when the camera is stored without a battery for a long period.



When the message is displayed, use the left and right keys of the controller (1) to select "Yes." "No" cancels the operation.



Press the center of the controller to open the date/time setup screen.

If the message is not displayed, the date/time setup screen can be opened in section 3 of the setup menu. See page 73 and 74 on how to open and navigate the menu.

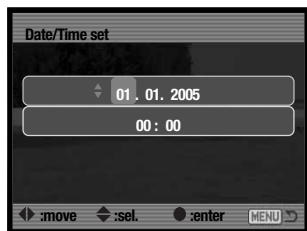

On the setup screen, use the left and right keys to select the item to be changed.



Use the up and down keys to adjust the item.



Press the center button to set the clock and calendar.

Date/Time setup screen

For customers in certain areas, the menu language must also be set. The language is changed in section 1 of the setup menu (p. 73).

## RECORDING MODE - BASIC OPERATION

This section covers basic recording operation. To prepare the camera for use, read pages 14 through 22.

### HANDLING THE CAMERA

While using the LCD monitor, grip the camera firmly with your right hand while supporting the camera body with your left. Keep your elbows at your side and your feet shoulder-width apart to hold the camera steadily.

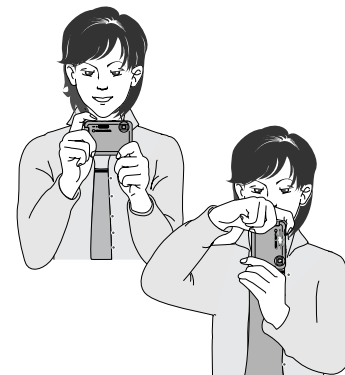

When taking vertical pictures, hold the camera so that the flash is above the lens with the shutter-release button to the top. Take care not to cover the lens with your fingers or the strap.

### SETTING THE CAMERA TO RECORD IMAGES

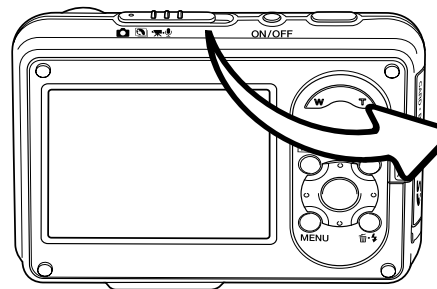

Slide the recording-mode switch to the appropriate position.

	Still-image recording.
	Digital Subject Programs (p. 31).
	Movie and audio recording (p. 36, 52).

## LCD MONITOR DISPLAY

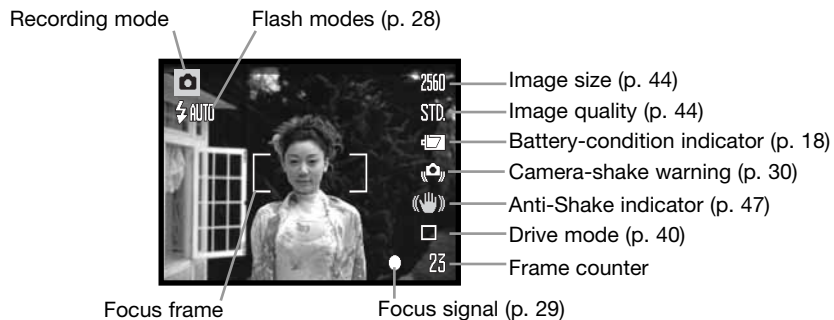

## USING THE ZOOM LENS

This camera is equipped with a unique 7.7 - 23.1mm zoom lens. This is equivalent to a 37 to 111mm lens on a 35mm camera. The lens is operated by the zoom lever at the back of the camera.

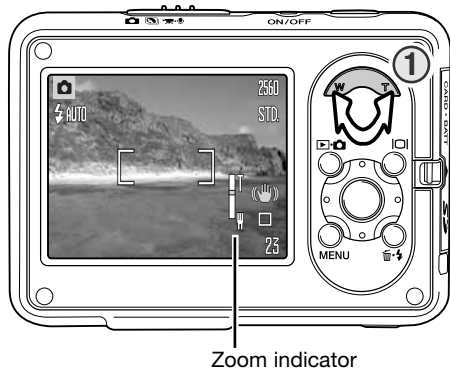

To zoom in on the subject, push the the right side (T) of the zoom lever (1).

To zoom out, push the the left side (W) of the zoom lever.

After zooming, the zoom indicator is displayed on the LCD monitor to show the approximate zoom position.

The digital-zoom function can increase the power of the lens. The digital zoom is activated in section 3 of the recording menu (p. 55).

## BASIC RECORDING OPERATION

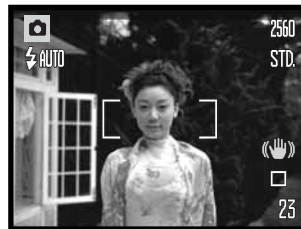

Place the subject anywhere within the focus frame. Make sure the subject is within the focus range of the lens (p. 26). For very close subjects, use the Super Macro function (p. 31).

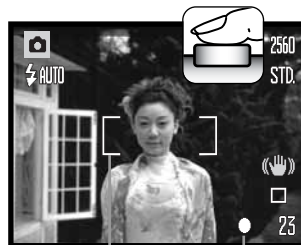

Press the shutter-release button partway down to lock the focus and exposure.

The white focus signal confirms focus. If the focus signal is red, the camera was unable to focus. Repeat the previous steps.

Press the shutter-release button all the way down to take the picture. The recorded image can be previewed by continuing to hold down the shutter-release button after the image is captured. The instant-playback function can also be used (p. 51).

Focus frame Focus signal

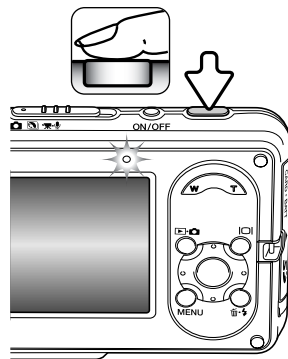

The indicator lamp blinks to show data is being written to the memory card. Never remove or insert a memory card while data is being transferred.

## FOCUS LOCK

The focus-lock function is used when you want to compose the image with the subject off-center and outside the focus frame. Focus lock may also be used when a special focusing situation prevents the camera from focusing on the subject. This function is controlled with the shutter-release button.

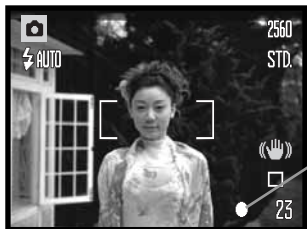

Place the subject within the focus frame. Press and hold the shutter-release button partway down to lock the focus.

The monitor focus signal indicates if the focus is locked.

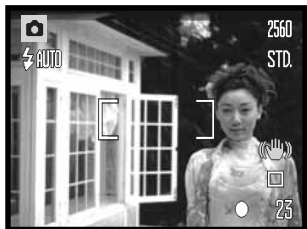

Without lifting your finger from the shutter-release button, recompose the subject within the image area. Press the shutter-release button all the way down to take the picture.

## FOCUS RANGE

The focus range depends on the zoom position. To focus closer than the distances below, use the Super Macro function (p. 31).

Wide-angle position	Telephoto position
0.1m ~ ∞ (4 in. ~ ∞)	0.4m ~ ∞ (16 in. ~ ∞)

## FOCUS SIGNALS

This digital camera has a quick, accurate autofocus system. The focus signal in the lower right corner of the LCD monitor indicates the focus status. The shutter can be released regardless if the camera can focus on the subject or not.

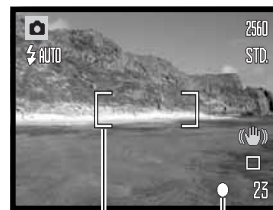

Focus frame

Focus signal

**Focus confirmed** - the LCD monitor focus signal is white. Focus is locked.

**Cannot focus** - the LCD monitor focus signal is red.

## SPECIAL FOCUSING SITUATIONS

The camera may not be able to focus in certain situations. In these situations the focus-lock function (p. 26) can be used to focus on another object at the same distance as your main subject, and then the image can be recomposed to take the picture.

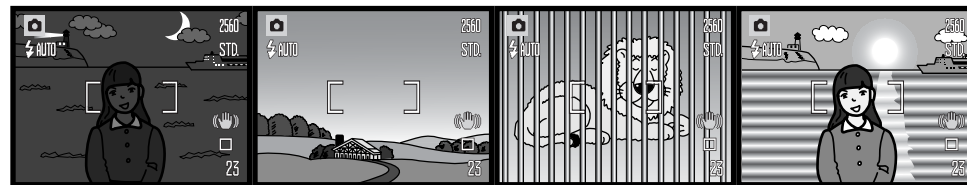

The subject is too dark.

The subject in the focus frame is low in contrast.

Two subjects at different distances overlap in the focus frame.

The subject is near a very bright object or area.

## FLASH MODES



The flash can be used when taking still images. To select the flash mode, press the flash button (1) on the back of the camera until the desired mode is displayed. The active flash mode is displayed in the top left corner of the LCD monitor. When the camera is turned off and auto reset (p. 76) is active, the flash mode is reset to autoflash with red-eye reduction if this mode was last used, if not the mode will be reset to autoflash. While the flash is charging, the shutter cannot be released.

**Autoflash** - the flash fires automatically in low-light and backlit conditions.

**Red-eye reduction** - the flash fires multiple bursts before the main flash burst to reduce red-eye; an effect caused by light reflected from the retina. Use in low-light conditions when taking photographs of people or animals, the pre-flashes contract the pupils of the subject's eyes.

**Fill flash** - the flash fires with each exposure regardless of the amount of ambient light. Fill flash can be used to reduce harsh shadows caused by strong direct light or sunshine.

	Autoflash
	Autoflash with red-eye reduction
	Fill-flash
	Flash cancel
	Slow-sync.



Fill flash

**Flash cancel** - the flash will not fire. Use flash cancel when flash photography is prohibited, natural light is desired to illuminate the subject, or the subject is beyond the flash range. The camera-shake warning may appear when flash cancel is selected (p. 30).



**Slow sync.** - for portraits in low light when the background detail is wanted. Red-eye reduction is active. The camera balances the subject and background exposures. The use of a tripod is recommended. Ask your subjects not to move after the main burst; the shutter may still be open for the background exposure.

## FLASH RANGE - AUTOMATIC OPERATION

The camera automatically controls the flash output. For well-exposed images, the subject must be within the flash range. Because of the optical system, the flash range is not the same at the lens' wide-angle position as it is at the telephoto position. The flash range can be changed with camera sensitivity (ISO), see page 49.

Wide-angle position	Telephoto position
0.3m ~ 2.2m (1.0 ft. ~ 7.2 ft.)	0.4m ~ 2.1m (1.3 ft. ~ 6.9 ft.)

## FLASH SIGNALS

The indicator lamp above the LCD monitor indicates the status of the flash. When the lamp blinks, the flash is charging and the shutter will not release.

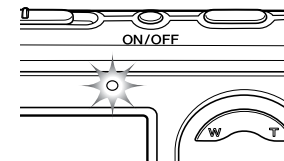



## DISPLAY BUTTON - RECORDING MODE

The display button controls the LCD monitor display. The display switches between full display and live image only each time the button is pressed. If auto reset (p. 76) is active, the display resets to full when the camera is turned off. If the display button is pressed and held, Hibright LCD activates, see page 52.

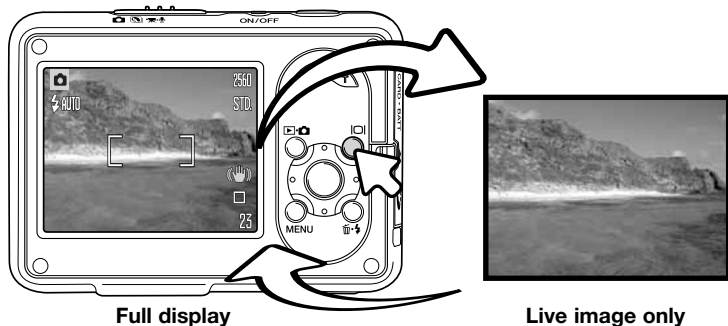

## CAMERA-SHAKE WARNING

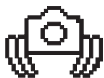

If the shutter speed falls below the point where the camera can be hand held safely, the camera-shake warning indicator appears on the monitor. Camera shake is slight blurring caused by subtle hand motion and is more pronounced at the telephoto position of the lens than at the wide-angle position. Although the warning appears, the shutter can still be released. If the warning appears, place the camera on a tripod or use the built-in flash.

## DIGITAL SUBJECT PROGRAMS

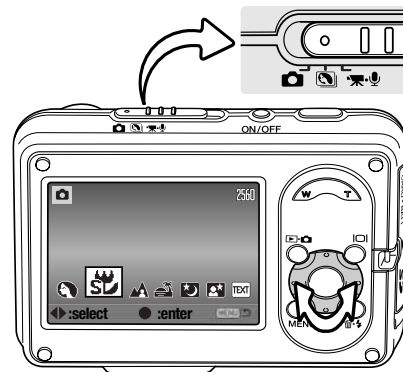

Digital subject programs optimize the camera's exposure, white-balance, and image-processing systems for specific conditions and subjects.

Set the recording-mode switch to the Digital Subject Program position. Simply press the left and right keys of the controller to select the appropriate subject program; the subject program indicator is enlarged when selected. Press the center button of the controller to enter the setting.

	Portrait
	Super Macro
	Landscape
	Sunset
	Night View
	Night Portrait
	Text

**Portrait** - optimized to reproduce warm, soft skin tones and a slight defocusing of the background. Most portraits look best at a telephoto setting; the longer focal length does not exaggerate facial features and the shallower depth of field softens the background. Use fill flash with strong direct sunlight or backlight to reduce harsh shadows.

**Super Macro** - for close-up photographs down to 5cm (2 in.). When selected, the lens zooms automatically to the Super Macro position; the zoom position cannot be changed. At close object distances, the flash may cause overexposure or uneven illumination, set the flash mode to flash cancel (p. 28). The use of a tripod is recommended.

**Landscape** - optimized to produce sharp, colorful landscapes. Used with bright outdoor scenery.

**Sunset** - optimized to reproduce rich, warm sunsets. When the sun is above the horizon, do not point the camera toward the sun for prolonged periods of time. The intensity of the sun could damage the CCD. Between exposures, turn off the camera.

**Night View** - for landscapes at twilight or night. The use of a tripod is recommended. The flash mode is fixed to flash cancel.

**Night Portrait** - for portraits at twilight or night. The flash and background exposures are balanced. The use of a tripod is recommended. The flash mode is fixed to slow sync. Ask your subjects not to move after the main burst; the shutter may still be open for the background exposure.

**Text** - To take pictures of black text or line art on white backgrounds.

## SPOT AF

The spot AF is used for selective focusing. Both focus and exposure are determined with the spot focus area. When auto reset (p. 76) is active, the spot AF area resets to the wide focus frame when the camera is turned off. When used with the digital zoom (p. 55), the spot focus area is enlarged.



Press and hold the center button of the controller to display the spot focus area; press and hold the button again to return to the wide focus frame. Take the picture as described in the basic recording operation section on page 25.

When the live image only display is used, switching between the wide and spot AF modes resets the display mode to the full display.

## PLAYBACK - BASIC OPERATION

Images can be viewed in the playback mode. The playback mode has additional functions, see page 61. Playback can also be used with the camera in the cradle, see page 36.

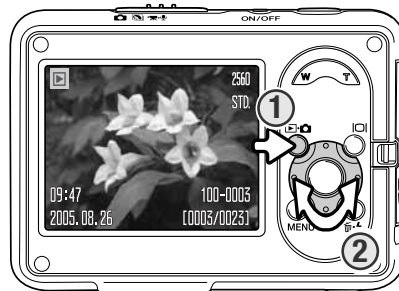

To view recorded images, press the mode button (1). If the camera is off, continue to press the button until the monitor activates.

Use the left/right keys of the controller to scroll through the images (2).

Press the mode button again to return to the recording mode.

## SINGLE-FRAME PLAYBACK DISPLAY

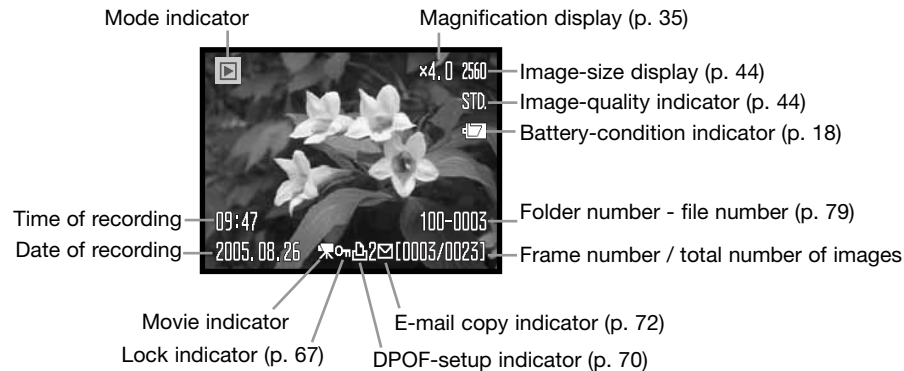

## ROTATING IMAGES

Press the down key of the controller (1) to rotate the displayed image 90° left, 90° right, and horizontally. The image is displayed in the selected orientation until changed.

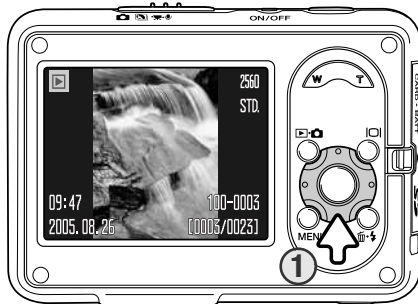

## DELETING SINGLE IMAGES

To delete a displayed file, press the delete button (1). A confirmation screen appears.



Use the left/right keys to select "Yes." "No" cancels the operation.



Press the center button of the controller to delete the file.



## DISPLAY BUTTON - PLAYBACK MODE

The display button controls the LCD monitor display. Each time the button is pressed, the display switches between full display and image only.

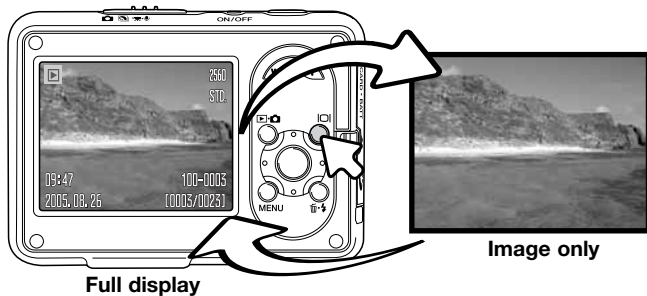

## ENLARGED PLAYBACK

In single-frame playback, a still image can be enlarged by up to 6X.

With the image to be magnified displayed, press the right side of the zoom lever (T) to activate the enlarged playback mode. The degree of magnification is displayed on the LCD monitor.

Press the right side of the zoom lever (T) to increase the image magnification. Press the left side of the lever (W) to decrease the magnification.

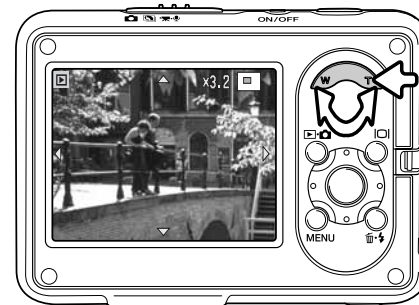

Use the four-way keys of the controller to scroll the image. When scrolling, the arrows in the display disappear when the edge of the image has been reached.



The locator in the top right corner of the monitor indicates the area of the image being displayed.



The display button switches between showing the full display and the image only.

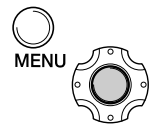

To exit enlarged playback, press the menu button or the center button of the controller.

## INDEX PLAYBACK

To view the recorded images in a 6-frame index, press the left side of the zoom lever (W).

In index playback, the left/right and up/down keys of the controller move the yellow border around the index thumbnails. When the image is highlighted with the border, the date of recording, audio-track indicator, the lock and printing status, e-mail copy indicator and the frame number of the image are displayed at the bottom of the screen. The accompanying audio track of the highlighted image can be played by pressing the center button of the controller. When the right side of the zoom lever (T) is pressed, the highlighted image is displayed in the single-frame playback mode.



## PLAYBACK ON THE CRADLE

Images can be played back with the camera in the cradle. Turn the camera off and place the camera in the cradle; see page 17 for details.

With the camera in the cradle, turn the camera on; charging stops and images can be viewed as described in the playback section. Pictures cannot be taken; only playback mode is available.

If the cradle is plugged into a live electrical outlet, it will power the camera. If the cradle is unplugged, the camera battery is used as the power source.

Always turn off the camera before removing it from the cradle.

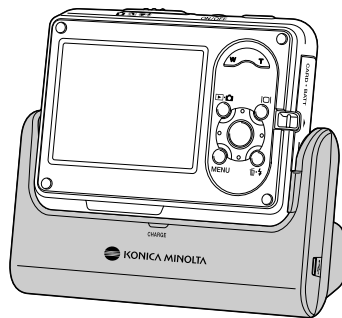

## RECORDING - ADVANCED OPERATION

### MOVIE RECORDING

This camera can record digital video with sound. Simply slide the recording-mode switch to the movie/audio recording position (1). The frame counter shows the total recording time for the next movie clip. Total recording time varies with the movie file size, see page 59. Some changes can be made with the movie/audio menu (p. 39).

Frame the subject and press the shutter-release button all the way down and release to begin recording (2). A digital zoom is available during recording. Both digital zoom and optical zoom can be turned on or off in section 1 of the movie/audio menu (p. 55, 59).

The camera continues to record until the recording time is used or the shutter-release button is pressed again. When recording, the frame counter displays the remaining time. During the last ten seconds, the counter turns red.

Take care not to cover the microphone while recording. Very bright light sources in the scene may cause streaks to appear on the image. Black areas caused by data loss may also be apparent.

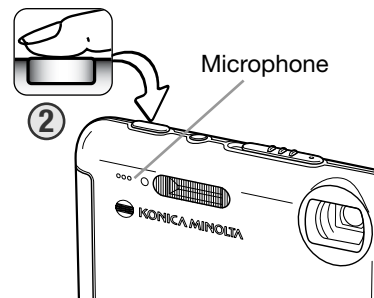
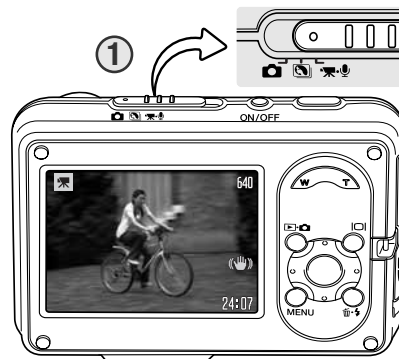

Image size

Anti-Shake indicator (p. 47)

Recording indicator

Remaining time

## NAVIGATING THE RECORDING MENUS

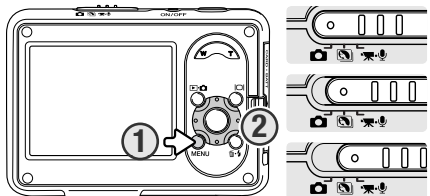

The recording menu displayed varies with the position of the recording-mode switch. Pressing the menu button (1) turns the menu on and off. The four-way keys of the controller (2) move the cursor in the menu. Pressing the center button of the controller enters a setting.



MENU

Activate the menu with the menu button.



Use the left/right keys of the controller to highlight the appropriate menu tab; the menu changes as the tabs are highlighted.



Use the up/down keys to scroll through the menu options. Highlight the option whose setting needs to be changed.



With the menu option highlighted, press the right controller key; the settings are displayed with the current setting highlighted. To return to the menu options, press the left key.



Use the up/down keys to highlight the new setting.



Press the center button of the controller to select the highlighted setting.

Once a setting has been selected, the cursor returns to the menu options and the new setting is displayed. To return to the recording mode, press the menu button.

### Still image recording

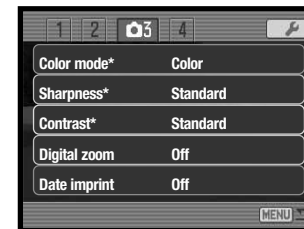
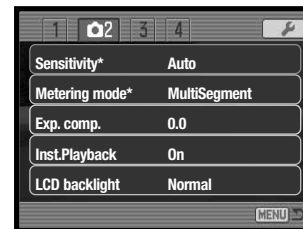
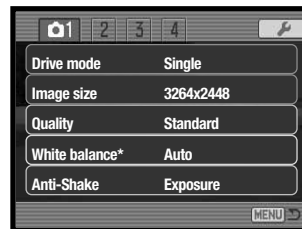

### Movie and audio recording

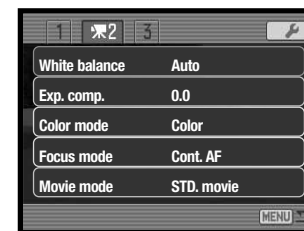
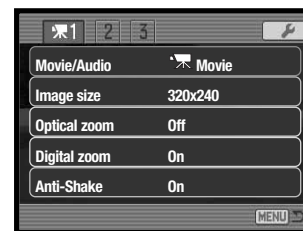

\* These functions are not available when the recording-mode switch is in the digital-subject-program position.



Refer to the following sections for details on the menu options and their settings.

#### Index to menu functions

Anti-Shake, 47

Audio, 60

Color mode, 52

Contrast, 54

Date imprinting, 56

Digital zoom, 55

Drive mode, 40

Exp. compensation, 50

Focus mode, 60

Image size, 44, 59

Instant playback, 51

Key function, 57

LCD backlight, 52

Metering mode, 49

Movie mode, 60

Movie/Audio, 58

Optical zoom, 59

Quality, 44

Sensitivity, 48

Sharpness, 53

White balance, 46

## DRIVE MODES

The drive modes control the rate and method images are captured. Indicators indicating the selected drive mode appear on the monitor. Drive modes can be selected in section 1 of the recording menu. See navigating the recording menu section on page 38.



**Single-frame advance** - to take a single image each time the shutter-release button is pressed. This is the camera's default setting.



**Self-timer** - to delay the release of the shutter (p. 40). Used for self-portraits.



**Continuous advance** - to take up to three images when the shutter-release button is pressed and held (p. 41).

**Advanced modes** - to use advanced drive modes: UHS continuous advance, Progressive Capture, UHS Progressive Capture, and Multi Frame.

### Self-timer

Used for self-portraits, the self-timer delays the release of the shutter for approximately ten seconds after the shutter-release button is pressed. The self-timer drive mode is selected in section 1 of the recording menu.

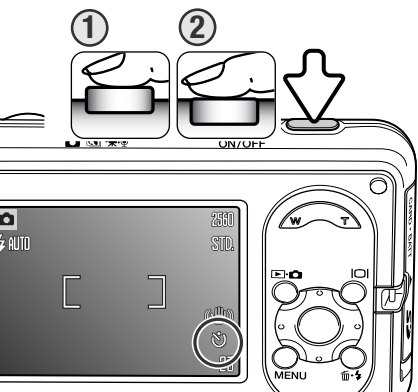

With the camera on a tripod, compose the picture as described in the basic recording operation section (p. 25). Press the shutter-release button partway down to lock the exposure and focus (1). Press the shutter-release button all the way down to begin the countdown (2). Because focus and exposure are determined when the shutter-release button is pressed, do not stand in front of the camera when taking a self-timer image. Always confirm the focus with the focus signals before beginning the countdown (p. 27).

During the countdown, the self-timer lamp on the front of the camera starts to blink and is accompanied by an audio signal. A countdown timer is displayed on the monitor. A few seconds before the exposure, the self-timer lamp blinks rapidly. The lamp glows steadily just before the shutter fires.

To stop the countdown, press the zoom lever or menu button. The drive mode resets to single-frame advance after the exposure. The audio signal can be turned off in section 2 of the setup menu (p. 77).

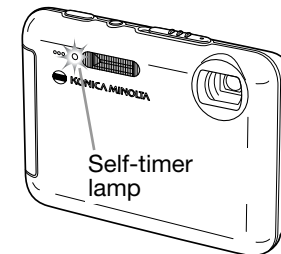

### Continuous advance

This mode continuously records images when the shutter-release button is pressed and held. With standard 3264 x 2448 images, the maximum number of pictures taken is three and the approximate rate of capture is 0.5 fps.. The continuous advance drive mode is selected in section 1 of the recording menu.

Compose the picture as described in the basic recording operation section (p. 25). Press the shutter-release button partway down to lock the exposure and focus for the series. Press and hold the shutter-release button all the way down to begin taking pictures. When the shutter-release button is pressed and held, the camera begins recording images until the maximum number has been taken or the shutter button is released. The maximum number depends on the image size and quality; for example, the number increases up to 20 with economy 1600 x 1200 images. Digital zoom (p. 55) reduces the number of images. The frame counter is adjusted after the series has been taken.

The built-in flash can be used, but the rate of capture is reduced because the flash must recharge between frames. Date imprinting (p. 56) also reduces the rate of capture. If noise reduction processing is applied, the rate of capture is reduced, see p. 42.



## Advanced modes

Four advanced drive modes are available: UHS continuous advance, Progressive Capture, UHS Progressive Capture, and Multi Frame.

To select each mode, select the advanced-modes option in section 1 of the recording menu. Press the center button of the controller to display four advanced modes. Use the left/right keys to select the mode. Press the center button again to complete the operation.

Flash cannot be used with the advanced drive modes.

Focus and exposure are locked at the first frame of a series. When the red low-battery warning is displayed, these modes cannot be used. Because of the limits to the shutter speeds, images may be underexposed in low-light conditions.

Very bright light sources in the scene may cause streaks to appear on the image. Black areas caused by data loss may also be apparent.

### UHS Continuous Advance

UHS continuous-advance mode captures up to 15 images at approximately 10fps while holding down the shutter-release button. The image size is fixed at 640x480. Digital zoom cannot be used. Image quality may be slightly lower than normal.

Operation is the same as that of continuous-advanced mode: compose the picture, and press and hold the shutter-release button all the way down; the camera will begin recording images until the shutter-button is released.

## Camera Notes

Noise reduction is applied automatically when the camera temperature is high or slow shutter speed is required. When processing is applied, the message is displayed after each exposure and next picture cannot be taken during this period. The rate of capture of continuous advance reduces.

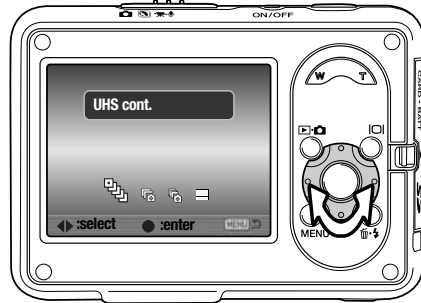

### Progressive Capture

The Progressive-Capture drive mode continuously records images while holding down the shutter-release button. With standard 3264 x 2448 images, the approximate rate of capture is 0.5 fps. When the shutter button is released, the last three images stored in the camera's buffer memory are saved.

Compose the picture as described in the basic recording operation section (p. 25). Press and hold the shutter-release button all the way down to begin taking pictures.

When the event has ended, release the shutter to save the images in the camera memory. The number of images in the memory depends on the image size and quality; three images are saved with standard 3264 x 2448 images, while 20 images are saved with economy 1600 x 1200 images.

The advantage of Progressive Capture over the continuous-advance drive mode is that it allows you to record events without the need to predict when the event will start. Simply hold the shutter-release button down to start saving images, and when the action ends, release the shutter button to save the recorded series.

Progressive Capture can only be used when there is enough space available on the memory card to record an entire series of images. Digital zoom cannot be used.

### UHS Progressive Capture

UHS Progressive Capture drive mode is the same as standard Progressive Capture, except the maximum number of recorded images is 15, the rate of capture is approximately 10fps, and the image size is fixed at 640x480. The frame counter must show 15 frames or more to use UHS Progressive Capture.

Digital zoom cannot be used. Image quality may be slightly lower than normal.

## Multi Frame

Take the picture as described in the basic recording operation section (p. 25). Once the series starts, the shutter button can be released; the camera continues recording at 3fps until all nine frames have been captured.



Image size is fixed to 2048x1536 and cannot be changed. Image size refers to the total area of all nine images, not the size of each individual thumbnail. Digital zoom cannot be used. Image quality may be slightly lower than normal.

## IMAGE SIZE AND IMAGE QUALITY

Changing image size affects the number of pixels in each image. The greater the image size, the larger the file size. Choose image size based on the final use of the image - smaller images are more suitable for web sites whereas larger sizes produce higher quality prints.

LCD monitor	Number of pixels (hor. X vert.)
3264	3264 X 2448
2560	2560 X 1920
2048	2048 X 1536
1600	1600 X 1200
640	640 X 480



<b>FINE</b>	Fine - high-quality JPEG image.
<b>STD.</b>	Standard - the default setting. (JPEG)
<b>ECON.</b>	Economy - the smallest file sizes. (JPEG)

Image quality controls the rate of compression, but has no effect on the number of pixels in the image. The higher the image quality, the lower the rate of compression and the larger the file sizes. If economical use of the memory is important, use the economy mode. Standard image quality is sufficient for normal usage. The fine mode produces the highest quality image and the largest image files.

Image size and quality must be set before the picture is taken. Changes are displayed on the LCD monitor. Image size and quality must be reset manually. Image size and quality are set in section 1 of the recording menu. See navigating the recording menu section on page 38.

If image size or quality are changed, the frame counter displays the approximate number of images that can be recorded at that setting. Images with differing sizes and qualities can be recorded. The number of images that can be recorded depends on the memory available and the file size of the images. The actual file size is determined by the scene; some subjects can be compressed further than others. See the chart below.

Approximate file sizes.						
Quality	Size	3264x2448	2560x1920	2048x1536	1600x1200	640x480
<b>Fine</b>		4.0 MB	2.5 MB	1.6 MB	960 KB	150 KB
<b>Standard</b>		2.0 MB	1.2 MB	800 KB	480 KB	80 KB
<b>Economy</b>		1.0 MB	600 KB	400 KB	240 KB	40 KB
Approximate number of stored images with 32MB memory card						
<b>Fine</b>		9	15	24	39	183
<b>Standard</b>		13	22	35	56	231
<b>Economy</b>		27	44	67	102	326

## Camera Notes

The frame counter indicates the approximate number of images that can be recorded with the available memory at the camera's image quality and size settings. Because the counter uses approximate file sizes, the actual image taken may not change the counter or may decrease it by more than one. When the frame counter displays zero, it indicates no more images at the image size and quality settings can be captured. Changing those settings may allow more images to be saved.







## WHITE BALANCE

White balance is the camera's ability to make different types of lighting appear neutral. The effect is similar to selecting daylight or tungsten film, or using color compensating filters in conventional photography. One automatic and four preset white-balance setting are available with still image and movie recording; white balance cannot be changed with digital subject programs. White balance is set in section 1 of the recording menu or in section 2 of the movie/audio recording menu (p. 38). White balance can be assigned to the controller (p. 57). When auto reset (p. 76) is active, the white balance is reset to automatic when the camera is turned off.

Automatic white balance compensates for the color temperature of a scene. In most cases, the auto setting balances the ambient light and creates beautiful images, even under mixed-lighting conditions. When the built-in flash is used, the white balance is set to the color temperature of the flash.

When one of the preset white-balance settings is selected, an indicator is displayed on the LCD monitor to indicate the active white-balance setting; the effect is immediately visible on the monitor. To record the ambient light, set the flash mode to flash cancel (p. 29). The built-in flash can be used with preset white-balance, but creates a pinkish or blueish cast with the fluorescent and tungsten settings. The flash is daylight balanced and produces good results with the daylight and cloudy settings.



-  **Daylight** - for outdoor and sunlit subjects.
-  **Cloudy** - for overcast outdoor scenes.
-  **Tungsten** - for incandescent lighting: household light bulbs.
-  **Fluorescent** - for fluorescent lighting: office ceiling lights.

## ANTI-SHAKE SYSTEM

The Anti-Shake system minimizes the affect of camera shake, a slight blurring caused by subtle hand motion. Camera shake is more pronounced at the telephoto setting than at the wide-angle. Anti-Shake is employed when the shutter speed falls below a certain limit depending on the focal length in use. The effectiveness of Anti-Shake depends on the shutter-speed in use and the degree of shaking. The system may not work with moving subjects or when the camera is panned.

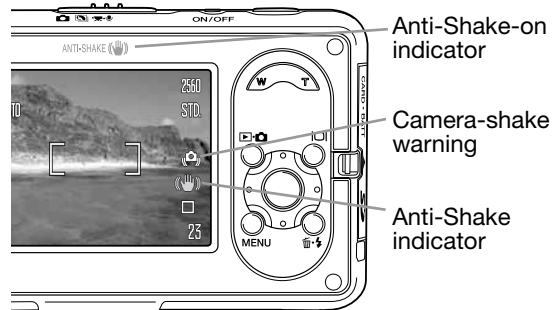

When the system is active, the Anti-Shake indicator appears. When the shutter-release button is pressed partway down, Anti-Shake-on indicator lights to indicate that Anti-Shake is active. Regardless of the Anti-Shake setting, if the shutter speed is too slow for the camera to be safely hand-held, the camera-shake indicator appears as a warning. Use the built-in flash or a wide-angle zoom position.

Frame the subject as described in the basic operation section and press the shutter-release button partway down, then all the way down to take the picture.

Anti-Shake can be selected in section 1 of the recording menus. Three options are available for still images. For movies, Anti-Shake has just two options: on or off.

**Display + Exp.** - when the shutter-release button is pressed partway down, the Anti-Shake function activates.

**Exposure** - Anti-Shake is only applied during the exposure and is not apparent in the live image. When the shutter-release button is pressed partway down, wait a moment before taking the picture for the Anti-Shake system to stabilize the image.

**Off** - Anti-Shake will not activate. When taking still images, use this mode if the camera's internal Anti-Shake movement is distracting.

When the red low-battery warning is displayed, Anti-Shake does not work. If Anti-Shake cannot compensate the camera motion, the Anti-Shake indicator turns red.

## CAMERA SENSITIVITY - ISO

Four camera sensitivity settings can be selected with a still image: Auto, 50, 100, 200; the numerical values are based on an ISO equivalent; the higher the number, the more sensitive the camera. Sensitivity can be changed in section 2 of the recording menu (p. 38). This cannot be changed with movie recording or digital subject programs. Sensitivity can be assigned to the controller (p. 57).

The auto setting automatically adjusts the camera sensitivity to the light conditions between ISO 50 and ISO 160. When any other setting than auto is used, "ISO" and the set value appear on the LCD monitor. When the camera temperature is high, the sensitivity may be adjusted between ISO 50 and 100.

A specific sensitivity setting can be selected. As the ISO value doubles, the camera sensitivity doubles. Like grain in silver-halide film that increases with speed, noise increases with the sensitivity in digital imaging; an ISO setting of 50 has the least noise and 200 has the most.

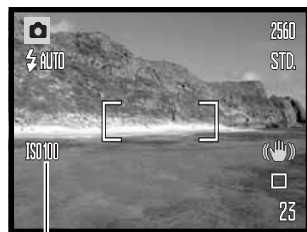

Camera sensitivity

## FLASH RANGE AND CAMERA SENSITIVITY

Because of the optical system, the flash range is not the same at the lens' wide-angle position as it is at the telephoto position.

ISO setting	Flash range (wide angle)	Flash range (telephoto)
AUTO	0.3m ~ 2.2m (1.0 ft. ~ 7.2 ft.)	0.4m ~ 2.1m (1.3 ft. ~ 6.9 ft.)
50	0.3m ~ 1.2m (1.0 ft. ~ 3.9 ft.)	0.4m ~ 1.1m (1.3 ft. ~ 3.6 ft.)
100	0.4m ~ 1.8m (1.3 ft. ~ 5.9 ft.)	0.4m ~ 1.6m (1.3 ft. ~ 5.2 ft.)
200	0.6m ~ 2.5m (2.0 ft. ~ 8.2 ft.)	0.6m ~ 2.3m (2.0 ft. ~ 7.5 ft.)

## METERING MODES

The metering mode is selected in section 2 of the recording menu (p. 38). Metering cannot be changed with the movie recording or digital subject programs.

Multi-segment metering: uses 300 segments to measure luminance and color. This data is combined with distance information to calculate the camera exposure. This advanced metering system gives accurate worry-free exposures in almost all situations.

Spot metering: uses a small area within the image to calculate the exposure. A small circle appears in the middle of the live image indicating the measuring area. The spot allows precise exposure measurements of a particular object without being influenced by extremely bright or dark areas within the scene.

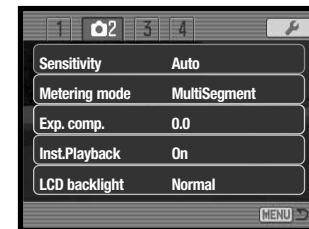

Spot-metering area

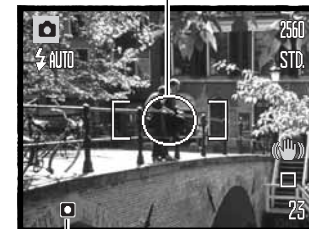

Spot-metering indicator

## EXPOSURE COMPENSATION

The camera exposure can be adjusted to make the final picture lighter or darker by as much as  $\pm 2\text{Ev}$  in 1/3 increments with still image and movie recording; exposure compensation cannot be used with digital subject programs. When auto reset (p. 76) is active, exposure compensation is reset to 0.0 when the camera is turned off. Exposure compensation can be assigned to the controller (p. 57). With the camera's default settings, exposure compensation can be adjusted with up/down keys of the controller.

Select the exposure compensation option in section 2 of the recording menus. Use the up/down keys to adjust the degree of compensation (1). Press the center button of the controller to set this value (2). If any value other than 0.0 is set, an indicator is displayed on the monitor as a warning.

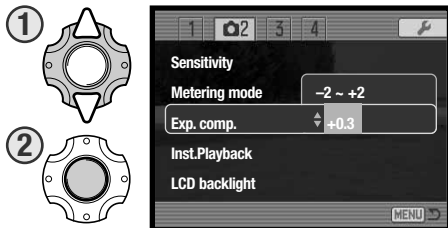

## Shooting tips

Sometimes the camera's exposure meter is deceived by certain conditions. Exposure compensation can be used in these situations. For example, a very bright scene, such as a snowy landscape or a white sandy beach, can appear too dark in the captured image. Before taking the picture, adjusting the exposure by +1 or +2 EV results in an image with normal tonal values.



Calculated camera exposure



-1.0Ev  
(1/2 as much light)



-2.0Ev  
(1/4 as much light)

In the example above, the dark water caused the camera to overexpose the image making it bright and washed-out. By compensating the exposure, detail is brought out in the leaves, and the stones and water appear richer. Ev stands for exposure value. A change of one Ev adjusts the exposure calculated by the camera by a factor of two.

## INSTANT PLAYBACK

After a still image is captured, it can be displayed on the monitor for two seconds before being saved. Instant playback shows the last frame in the series when used with the continuous-advance drive mode (p. 41).

Instant playback can be activated in section 2 of the recording menu (p. 38).

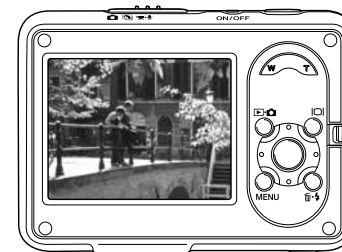

## HIBRIGHT LCD

Monitor brightness can be increased so that the monitor is easier to view in bright outdoor conditions. Simply press and hold the display button; monitor brightness increases. If the button is pressed and held again, the monitor returns to normal brightness. The Hibright LCD indicator appears on the monitor when active.

Hibright LCD can also be turned on or off in section 2 of the recording menu (p. 38).

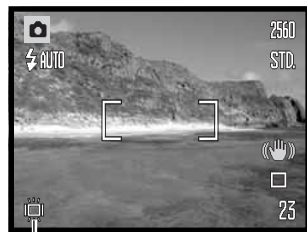

Hibright LCD indicator

## COLOR MODE

The color mode controls whether an image is color or black and white. The color mode is set in section 3 of the still-image recording menu or in section 2 of the movie/audio recording menu (p. 38). The color mode cannot be changed with digital subject programs. The color mode can be assigned to the controller (p. 57).

The black & white mode produces neutral monochrome images. Sepia creates warm-tone monochrome images. The monitor live image reflects the selected color mode. The color option uses no monitor indicator when active. The color mode has no effect on image file size.



## SHARPNESS

Sharpness accents or softens details in an image in three levels: hard (+), normal, and soft (-). This can be set in section 3 of the recording menu (p. 38). Sharpness cannot be changed when using digital subject programs.

Any changes made are applied to the live image, but may be difficult to see. However, when viewed with a computer, the changes will be evident. If any level except normal is selected, an indicator appears on the monitor as a warning.

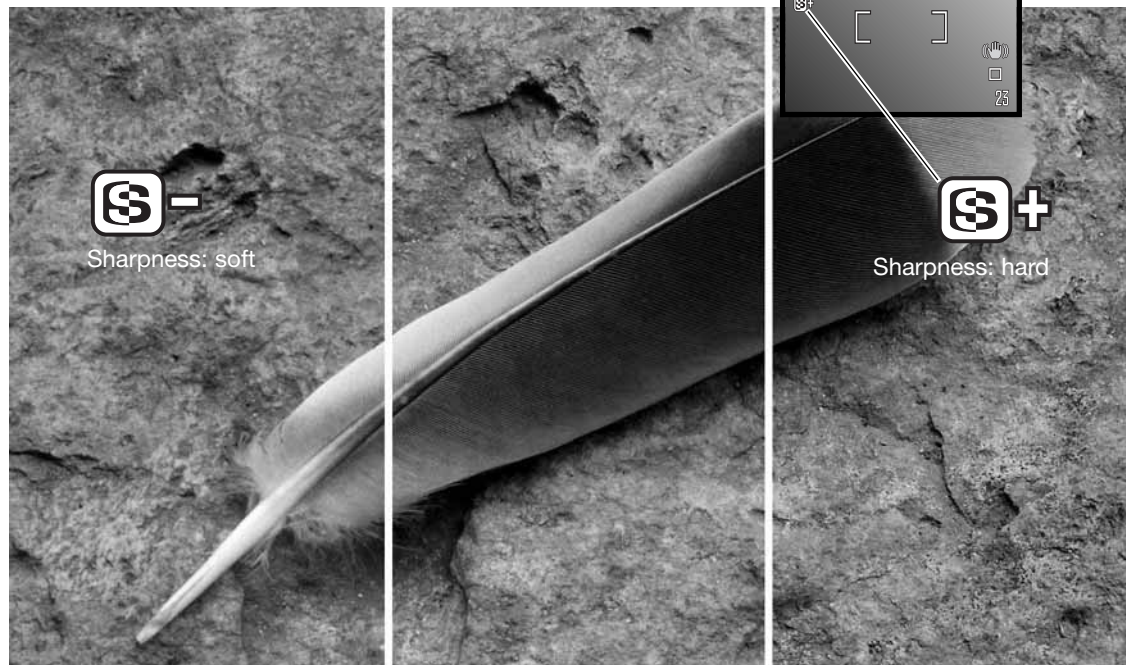
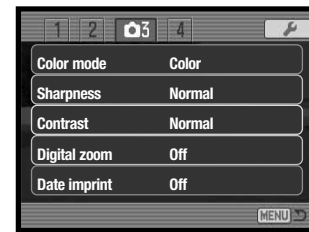

## CONTRAST

This function increases or decreases the contrast of the scene in three levels: high (+), normal, and low (-). This can be set in section 3 of the recording menu (p. 38). Contrast cannot be changed when using digital subject programs. Any changes made are applied to the live image. If any level except normal is selected, an indicator appears on the monitor as a warning.

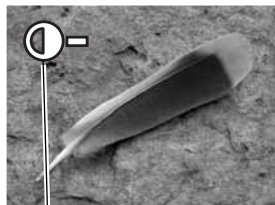

Contrast: low



Contrast: normal

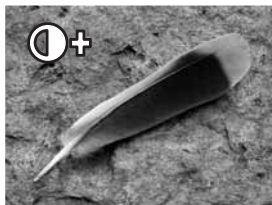

Contrast: high

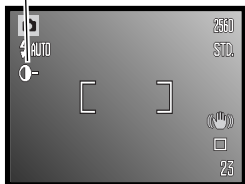

## DIGITAL ZOOM

The digital zoom for still images is activated in section 3 of the recording menu (p. 38). The digital zoom increases the magnification of the greatest telephoto setting of the optical zoom by up to 4.0X. Although the images recorded with the digital zoom are interpolated to the set image size, the quality of the images may not be equal to images taken without the digital zoom; the greater the power of the digital zoom the lower the image quality.

At the maximum telephoto position, continue to press the right side (T) of the zoom lever (1) to engage the digital zoom. The zoom magnification is displayed in the top right corner of the monitor.

To zoom out, press the the left side (W) of the zoom lever.

After zooming, the zoom indicator is displayed on the LCD monitor to show the approximate zoom position.

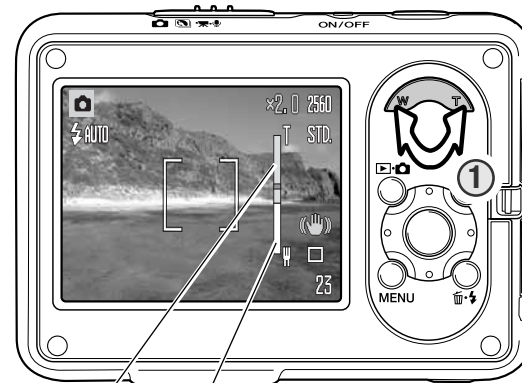

Optical zoom range

Digital zoom range

In movie recording mode, the digital zoom is turned on or off in section 1 of the movie/audio menu (p. 38). The digital zoom is only available when recording with 320x240 movies. The optical zoom can also be turned on or off in movie/audio menu.

## DATE IMPRINTING

The date and time of recording can be printed directly on a still image. The imprinting function must be activated before the image is taken. Once activated, the date will continue to be imprinted until the function is reset; a yellow bar is displayed behind the frame counter on the monitor to indicate the imprinting function is active.

Date imprinting is activated with section 3 of the recording menu (p. 38). Date imprinting has two menu options. The YYYY/MM/DD option prints the date. The MM/DD/hr:min option prints the month, day, and time of recording.

The date and time are imprinted in the lower right corner of the image when viewed horizontally. It is printed directly on the photograph writing over the image information. The date can be imprinted in three formats: year / month / day, month / day / year, and day / month / year. The date and date format are set in section 3 of the setup menu (p. 73).



Date-imprinting indicator



### Camera Notes

The date and time of recording can be viewed with the camera in the playback mode, or on a computer with DiIMAGE Master Lite. This software is provided on the Digital Camera Software CD-ROM included with the camera.

## CUSTOM KEY FUNCTION

In the recording mode, a function can be assigned to the up/down or left/right keys of the controller. This function is specified in section 4 of the recording menu (p. 38). This function cannot be used with the digital subject programs. Refer to the following sections for information on drive modes (p. 40), exposure compensation (p. 50), white balance (p. 46), and camera sensitivity (p. 48).

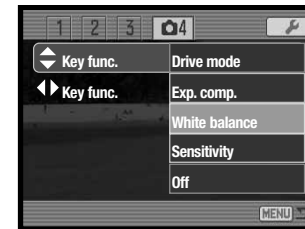

In the recording mode, use the up/down or left/right keys of the controller to change the function set with the menu.

The LCD monitor displays the settings as they are changed. The changes are visible in the monitor image. The function is set automatically after five seconds or when another camera button is pressed.

## RECORDING MODE

The recording-mode menu options switches between movie and audio recording. This option is located in section 1 of the movie/audio menu (p. 38).

## AUDIO RECORDING

Audio can be recorded without an image. About 31 minutes 47 seconds of audio can be stored on the 32MB memory card. Audio is recorded at approximately 16KB/s. A maximum of 180 minutes can be recorded at one time; optional AC adapter is required for long recordings.

Slide the recording-mode switch to the movie/audio recording position. In section 1 of the menu, change the recording mode to audio, see page 38.

Before recording, the approximate recording time available is displayed on the frame counter. To begin recording, press and release the shutter button.

The frame counter counts down the time. The recording stops when the shutter-release button is pressed again or the remaining time has elapsed.

When making audio recordings, be careful not to touch or cover the microphone. The quality of the recording is proportional to the subject to microphone distance. For best results, hold the camera approximately 20cm (8in) from your mouth.



Remaining recording time

## MOVIE IMAGE SIZES

Movies can be recorded at 640x480 and 320x240. Image size affects movies the same as it does for still images: the larger the image size, the larger the file size. Movie image size is set in section 1 of the movie/audio menu (p. 38).

## MOVIE FILE SIZES

If image size is changed, the frame counter displays the approximate number of seconds that can be recorded. The total time that can be recorded is determined by the available memory and the image size. The actual file size is determined by the scene; some subjects can be compressed further than others.

Approximate recording rate	
640x480	1020KB/s
320x240	420KB/s
Storage capacity (approx.)	
32MB memory card	
640x480	29sec.
320x240	1 min. 10sec.

The writing speed of the memory card may prematurely end the recording of a movie clip. Test the card before important events. Check the Konica Minolta web site for the latest compatibility information:

North America: <http://kmpi.konicaminolta.us/>  
Europe: <http://www.konicaminoltasupport.com/>

## OPTICAL ZOOM

The use of the optical zoom during recording can be turned on or off in section 1 of the movie/audio menu (p. 38). The optical zoom does not affect the picture quality, however, if it is used while recording, the sound of the zoom will be audible during playback. The optical zoom can always be used before recording regardless of the menu setting. If both the optical zoom and digital zoom are on during movie recording, the digital zoom activates only when the telephoto limit of the optical zoom has been reached.

## MOVIE FOCUS MODE

The movie autofocus mode can be specified between continuous AF and single-shot AF in section 2 of the movie/audio menu (p. 38). Continuous AF continually focuses the camera; focus is locked when the shutter-release button is pressed partway down, but it is continually adjusted during recording. Single-shot AF allows the focus to be locked before recording the image.

## MOVIE MODE

The movie-mode option selects the type of movie recorded. Standard produces a normal movie clip. Night Movie uses high camera sensitivity to record under low light levels; camera sensitivity increases automatically in low light. Image quality can be lower with Night Movies because of the higher sensitivity. The movie mode is set in section 2 of the movie/audio menu (p. 38).

## MOVIE AUDIO

Movie audio can be turned on or off in section 3 of the movie/audio menu (p. 38). If it is turned off, the movie file size will be smaller than those listed on page 59.

## PLAYBACK - ADVANCED OPERATION

The basic functions in this mode are described in the basic playback section on pages 32 through 35. This section covers how to playback movie clips and audio tracks as well as the advanced function on the playback menu.

## PLAYING BACK MOVIES AND AUDIO RECORDINGS

Movie clips and audio recordings are played back the same way. Use the left/right keys of the controller to display the movie or audio file; audio files are displayed with a blue screen.



Movie file



Press the center button of the controller to playback a movie or audio file.



Audio file



Press the center button of the controller to pause and restart the movie or audio playback.



To cancel the playback, press the menu button.

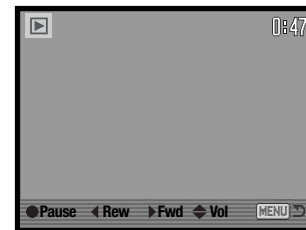

During playback, the up/down keys adjust the volume and the left/right keys rewind and fast forward the recording.



## NAVIGATING THE PLAYBACK MENU

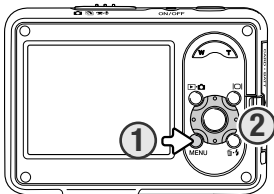

Navigating the menu is simple. The menu button turns the menu on and off (1). The left/right and up/down keys of the controller (2) control the cursor and change settings on the menu. Pressing the center button of the controller selects menu options and sets adjustments.



MENU

Activate the menu with the menu button.



Use the left/right keys of the controller to highlight the appropriate menu tab; the menu changes as the tabs are highlighted.



Use the up/down keys to scroll through the menu options. Highlight the option whose setting needs to be changed.



Press the right controller key to display the settings with the current setting highlighted. To return to the menu options, press the left key. If "Enter" is displayed, press the center button to display the setting screen.



Use the up/down keys to highlight the new setting.



Press the center button of the controller to select the highlighted setting.

Once a setting has been selected, the cursor returns to the menu options and the new setting is displayed. To return to the playback mode, press the menu button.

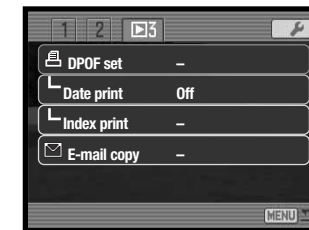
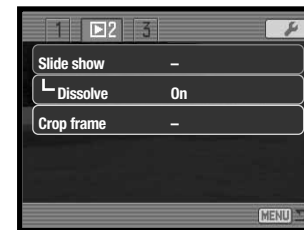

### Index to menu functions

Audio caption, 66  
Crop frame, 69  
Date print, 71  
Delete, 64

Dissolve, 68  
DPOF setup, 70  
E-mail copy, 72  
Format, 65

Index print, 71  
Lock, 67  
Slide show, 68

### Frame-selection screen

When a marked-frames setting is chosen on the menu, the frame-selection screen appears. This screen allows multiple image and audio files to be chosen.

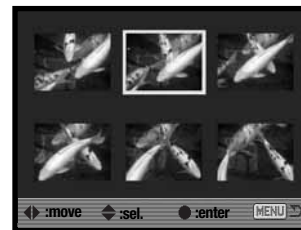

The left/right keys of the controller move the yellow border to select the image.



The up key of the controller selects the frame; when selected, an indicator appears next to the image. The down key deselects the image removing the indicator.



Press the center button of the controller to complete the operation.

MENU The menu button cancels the screen and any operation made.



Indicators may be displayed on the right of each index image to indicate movie, audio, and E-mail copy files.

## DELETING IMAGE AND AUDIO FILES



Deleting permanently erases the file. Once deleted, a file cannot be recovered. Care should be taken when deleting images.

Single, multiple, or all files can be deleted in section 1 of the playback menu (p. 62). Files must be unlocked before they can be deleted (p. 67). Delete has four options:

<b>This frame</b>	The file displayed or highlighted in playback mode is deleted.
<b>Audio track</b>	The audio caption attached to the displayed or highlighted image is deleted.
<b>All frames</b>	All unlocked files on the memory card are deleted.
<b>Marked frames</b>	To delete multiple files. When this setting is chosen, the frame-selection screen is displayed (p. 63). Use the left/right keys of the controller to highlight the first file to be deleted. Pressing the up key marks the thumbnail with the garbage-can indicator. To deselect a file for deletion, highlight it with the yellow border and press the down key; the garbage-can indicator disappears. Continue until all the files to be deleted are marked. Press the center button of the controller to continue (a confirmation screen appears), or press the menu button to cancel the operation and return to the playback menu.

Before a file is deleted, a confirmation screen appears. Choosing “Yes” executes the operation, “No” cancels it.



## FORMATTING MEMORY CARDS



When a memory card is formatted, all data is erased.

The formatting function is used to erase all data on a memory card. Before formatting, copy the data to a computer or storage device. Locking images will not protect them from being deleted when the card is formatted. Always format the card using the camera; never use a computer.

When the format option is selected and entered in section 1 of the playback menu (p. 62), a confirmation screen appears. Choosing “Yes” formats the card, choosing “No” cancels the formatting operation. A message appears to indicate the card has been formatted.

If the unable-to-use-card message appears, the inserted card in the camera may need to be formatted. A memory card used in another camera may also have to be formatted before being used.



## AUDIO CAPTION

A still image can have a fifteen-second audio caption attached to it. Files must be unlocked to use this function (p. 67).

Display the image to which the audio caption will be attached.

On the playback menu (p. 62), highlight the Enter setting in the audio-caption option. Press the center button of the controller (1) to start recording.

If an audio track is already attached to the image, a confirmation screen appears. Choosing and entering “Yes” starts the audio caption recording replacing the previous audio track. “No” cancels the audio-caption operation.

A status bar and clock display the remaining recording time. The audio caption can be stopped by pressing the center button of the controller (1).

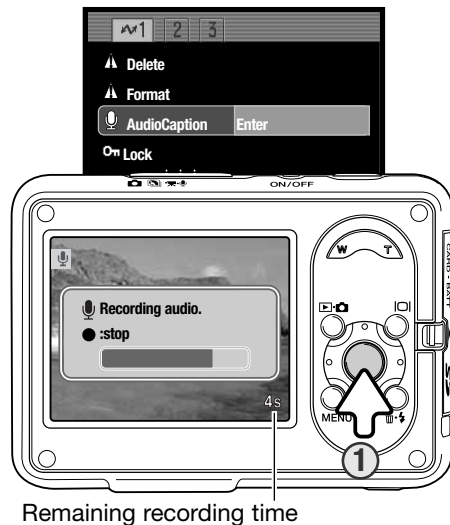

Remaining recording time

## LOCKING FILES

Single, multiple, or all files can be locked. A locked file cannot be erased by a delete function. However, the formatting function (p. 65) will erase all files whether locked or not. The lock function is in section 1 of the playback menu (p. 62). Lock has four options:

<b>This frame</b>	The file displayed or highlighted in playback mode is locked or unlocked.
<b>All frames</b>	All files on the memory card are locked.
<b>Marked frames</b>	To lock or unlock multiple files. When this setting is chosen, the frame-selection screen is displayed (p. 63). Use the left/right keys of the controller to highlight the file to be locked. Pressing the up key marks the file with the lock indicator. To unlock a file, highlight it with the yellow border and press the down key; the lock indicator disappears. Continue until all the files to be locked are marked. Press the center button of the controller to lock the files, or press the menu button to cancel the operation.
<b>Unlock all</b>	To unlock all files on the memory card.

## SLIDE SHOW

Section 2 of the playback menu (p. 62) controls the slide-show function. This function automatically displays and plays all image, audio, and movie files on the memory card in order.

To start the slide-show presentation, highlight “Enter” and press the center button of the controller.

During the slide show, pressing the center button of the controller pauses and restarts the presentation.

The left/right keys advance the next still image or return to the previous one. During a movie, the keys forward or rewind the clip.

Press the menu button to cancel the presentation.

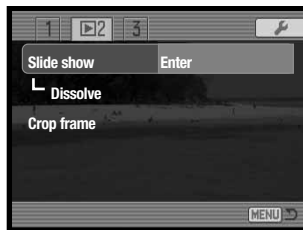
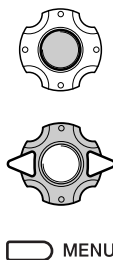

## DISSOLVE

The dissolve function randomly selects a dissolve effect for transitions between still images in the slide show. This function can be turned on and off in section 2 of the playback menu (p. 62).

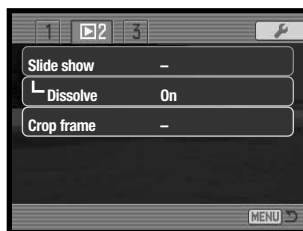

## CROP FRAME

A portion of a still image can be copied and saved in the memory card. 640x480 size images or E-mail Copy images cannot be cropped.

Display the image to be cropped on the LCD monitor. Highlight “Enter” in the crop-frame option in section 2 of the playback menu (p. 62) and press the center button to start the cropping process.

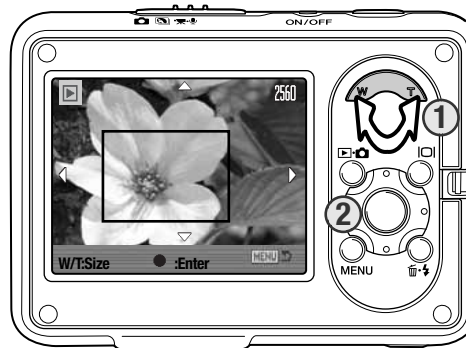
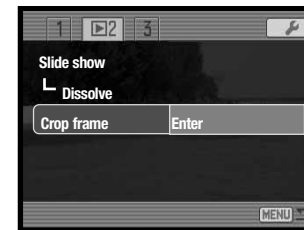

The cropping area is displayed with a red frame. Adjust the size of the cropping area with the zoom lever (1). Use the controller to move the cropping area (2).



When the image area to be cropped is framed, press the center button of the controller to save the image data.



Before a cropped area is copied, a confirmation screen appears. Choosing “Yes” executes the operation, “No” cancels it.



The file name of the cropped image is displayed. Press the center button of the controller again to complete the operation.

## ABOUT DPOF

This camera is supported by DPOF™. The DPOF (Digital Print Order Format) allows direct printing of still images from digital cameras. After the DPOF file is created, the memory card is simply taken to a photofinishing service or inserted into the memory-card slot of DPOF compatible printers. When a DPOF file is created, a misc. folder is automatically created on the memory card to store it (p. 88).

## DPOF SETUP

The DPOF-set menu option in section 3 of the playback menu (p. 62) is used to create an order for standard prints from still images on the memory card. DPOF setup has four options.

<b>This frame</b>	To create a DPOF file for the displayed or highlighted image.
<b>All frames</b>	To create a DPOF file for all images in the memory card.
<b>Marked frames</b>	To choose a group of images to be printed or when the number of copies of each image varies. When selected, the frame selection screen appears (p. 63). Use the left/right keys of the controller to highlight an image to be printed. Pressing the up key marks the image. The number indicates the number of copies that will be printed. Pressing the up key increases the number of copies, pressing the down key decreases the number. A maximum of nine copies can be ordered. To deselect an image for printing, press the down key until the number of copies reaches zero and the printer indicator disappears. Continue until all the images to be printed are marked. Press the center button of the controller to create the DPOF file, or press the menu button to cancel the operation and return to the playback menu.
<b>Cancel all</b>	To delete the DPOF file.

When the this-frame or all-frames setting is chosen, a screen appears requesting the number of copies of each image; a maximum of nine copies can be ordered. Use the up/down keys of the controller to set the required number of copies. If the all-frames setting was used to create a print order, any additional images recorded afterwards are not included in the order.

DPOF files created with another camera are deleted when a DPOF file is created. After the pictures have been printed, the DPOF file remains and must be canceled manually.

DPOF information is not copied with images. To create a DPOF file for copied images, repeat the DPOF setup procedure again.

## DATE PRINT

To print the date of capture with each image with a DPOF compatible printer, turn the section 3 menu option on. To cancel date print, simply turn the option off. How and where the date is printed varies with the printer.

## INDEX PRINT

To create an index print of all the images on the card, select “Yes” in the index print option in section 3 of the playback menu. To cancel an index print, simply change the setting to “No.”

If an index-print order is created, any additional images saved afterwards will not be included in the index print. The number of images printed per sheet differs between printers. The information printed with the thumbnails can vary.



## Camera Notes

DPOF files and images can be printed directly from the camera with a DPOF compatible PictBridge printer, see pages 94 and 99.

## E-MAIL COPY

E-mail Copy in section 3 of the playback menu makes a 640 X 480 JPEG copy of an original still image so that it may be easily transmitted by e-mail.

When the copy function is used, a folder is created for the files (p. 88); images are placed in a folder ending in EM. The same E-mail Copy folder is used to store copies until the number of images exceed 9,999. Images with audio are copied with their audio files. Copies of locked images are unlocked. DPOF information is not copied. The E-mail copy function has two menu options:

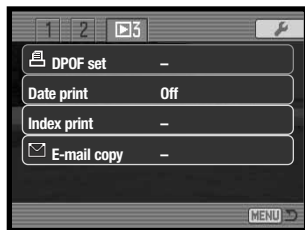

<b>This frame</b>	To copy the file displayed or highlighted in the playback mode.
<b>Marked frames</b>	To copy single or multiple files. When selected, the frame-selection screen appears (p. 63); highlight the file to be copied with the yellow border and then press the up key of the controller to mark it with the check indicator. To deselect a file to be copied, highlight the selected thumbnail and press the down key; the check disappears. Continue until all the files to be copied are marked. Press the center button of the controller to continue, or press the menu button to cancel the operation and return to the playback menu.



When the image(s) to be converted to an e-mail file are selected, the copy routine begins and a screen appears indicating the name of the folder containing the copied images; press the center button of the controller to return to the menu.

### Camera Notes

The copy-unsuccessful message appears when one or all of the images could not be copied. Check the memory card to see which files were copied and then repeat the procedure for the uncopied images.

## SETUP MODE

The setup menu is used to control the camera's functions and operation. The navigating the setup menu section covers the operation of the menu. The section is followed by detailed descriptions of the settings.

### NAVIGATING THE SETUP MENU

The setup menu is opened from the other menus. It can be accessed from any of the recording or playback menus.

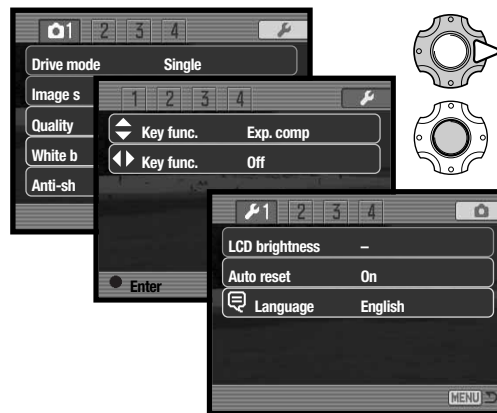

Use the right key to highlight the setup tab at the top of the menu.



Press the center button to open the setup menu.

Reverse the procedure to return to the original menu. Pressing the menu button closes the setup menu and returns to the recording or playback modes.

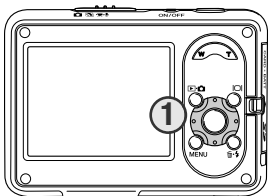

Navigating the menu is simple. The four-way keys of the controller (1) control the cursor and change settings on the menu. Pressing the center button of the controller selects menu options and sets adjustments.



Use the left/right keys of the controller to highlight the appropriate menu tab; the menu changes as the tabs are highlighted.



Use the up/down keys to scroll through the menu options. Highlight the option whose setting needs to be changed.



With the menu option highlighted, press the right controller key; the settings are displayed with the current setting highlighted. If "Enter" is displayed, press the center button of the controller to continue.



Use the up/down keys to highlight the new setting.



Press the center button of the controller to select the highlighted setting.

Once a setting has been selected, the cursor returns to the menu options and the new setting is displayed. To close the menu, press the menu button.

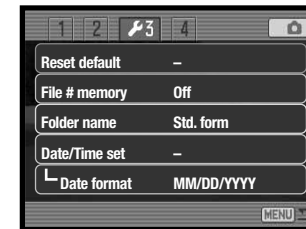
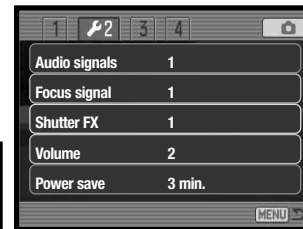

### Index to menu functions

Audio signals, 77

Auto reset, 76

Date format, 80

Date / Time setup, 80

File # memory, 79

Firmware ver., 82

Focus signal, 77

Folder name, 80

Language, 76

LCD brightness, 75

Power save, 77

Reset default, 78

Shutter FX, 77

Transfer mode, 82

Video output, 80

Volume, 77

## LCD MONITOR BRIGHTNESS

The brightness of the LCD monitor can be set in eleven levels. The brightness setting screen is opened from section 1 of the setup menu (p. 73).

Use the left/right keys of the controller to adjust the brightness, the monitor image changes accordingly. Press the center button of the controller to set the brightness level.

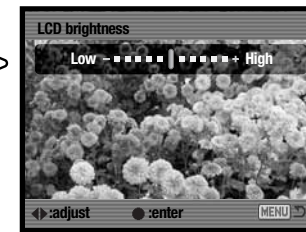

## AUTO RESET

When auto reset is active, the following functions reset when the camera is turned off. This function can be turned off in section 1 of the setup menu (p. 73).

<b>Flash mode (p. 28)</b>	<b>Autoflash</b>
<b>Monitor display (p. 30)</b>	<b>Full display</b>
<b>AF area (p. 32)</b>	<b>Wide focus frame</b>
<b>Drive mode (p. 40)</b>	<b>Single-frame advance</b>
<b>White balance (p. 46)</b>	<b>Auto</b>
<b>Anti-Shake (p. 47)</b>	<b>Exposure</b>
<b>Camera sensitivity (p. 48)</b>	<b>Auto</b>
<b>Metering mode (p. 49)</b>	<b>Multi-segment</b>
<b>Exposure compensation (p. 50)</b>	<b>0.0</b>
<b>Hibright LCD (p. 52)</b>	<b>Off</b>
<b>Color mode (p. 52)</b>	<b>Color</b>
<b>Sharpness (p. 53)</b>	<b>Normal</b>
<b>Contrast (p. 54)</b>	<b>Normal</b>

The flash mode is reset to auto-flash or autoflash with red eye reduction depending on which of those two flash modes were last used.

## LANGUAGE

The language used in the menus can be changed. The language is selected in section 1 of the setup menu (p. 73).

## AUDIO SIGNALS

Every time a button is pressed, an audio signal gives a positive confirmation of the operation. The audio signals can be turned off in section 2 of the setup menu (p. 73). Two audio signals are available.

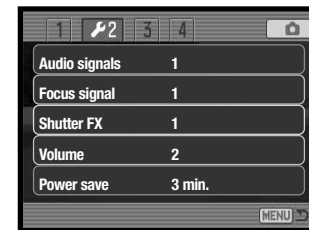

## FOCUS SIGNAL

When the shutter-release button is pressed partway down, an audio signal confirms the AF system has focused. The focus signals can be changed or turned off in section 2 of the setup menu (p. 73). Two tones are available.

## SHUTTER FX

When the shutter is released, a shutter sound effect will give a positive confirmation of the operation. The sound effect can be changed or turned off in section 2 of the setup menu (p. 73). Two shutter effects are available.

## VOLUME

The volume of the audio signals and shutter FX can be increased or decreased in section 2 of the setup menu (p. 73). This affects the camera's audio signals only and will not change the playback levels of an audio track.

## AUTO POWER SAVE

To conserve battery power, the camera shuts down if an operation is not made within a certain period. To restore power, press any button. The length of the auto-power-save period can be changed in section 2 of the setup menu (p. 73): 1, 3, 5, 10, and 30 minutes. The length of the auto-power-save period is fixed at 10 minutes when the camera is connected to a computer or PictBridge printer.



## RESET DEFAULT

This function in section 3 of the setup menu (p. 73) affects all modes. When selected, a confirmation screen appears; choosing “Yes” resets the following functions and settings, “No” cancels the operation.

Recording mode		
Flash mode	Autoflash	p. 28
Monitor display	Full display	p. 30
Focus area	Wide focus frame	p. 32
Drive mode	Single-frame advance	p. 40
Image size	3264 x 2448	p. 44
Image quality	Standard	p. 44
White balance	Auto	p. 46
Anti-Shake	Exposure	p. 47
Camera sensitivity (ISO)	Auto	p. 48
Metering mode	Multi segment	p. 49
Exposure compensation	0.0	p. 50
Instant playback	Off	p. 51
Hibright LCD	Off	p. 52
Color mode	Color	p. 52
Sharpness	Normal	p. 53
Contrast	Normal	p. 54
Digital zoom	Off	p. 55
Date imprinting	Off	p. 56
Up/down custom key function	Exposure compensation	p. 57
Right/left custom key function	Off	p. 57
Recording mode (Movie)	Movie	p. 58
Image size (Movie)	320 x 240	p. 59
Optical zoom (Movie)	Off	p. 59
Digital zoom (Movie)	On	p. 55
Anti-Shake (Movie)	On	p. 47

Focus mode (Movie)	Single-shot AF	p. 60
Movie mode	Standard movie	p. 60
Audio (Movie)	On	p. 60

Playback mode		
Monitor display	Full display	p. 34
Dissolve	On	p. 68
Date print	Off	p. 71

Setup menu		
LCD Brightness	Normal	p. 75
Auto reset	On	p. 76
Audio signals	1	p. 77
Focus signal	1	p. 77
Shutter FX	1	p. 77
Volume	2	p. 77
Auto-power-save period	3 minute	p. 77
File number (#) memory	Off	p. 79
Folder name	Standard	p. 80
Transfer mode	Data storage	p. 82

## FILE NUMBER (#) MEMORY

If file number memory is selected, when a new folder is created or a new memory card is used, the next image recorded will have a number one greater than the last file saved. If the new card contains an image with a greater file number, the new image will be assigned a file number one greater than the greatest on the card.

If the file number memory is disabled, the image file number will be 0001 when saved in a new folder or card. File number memory is activated in section 3 of the setup menu (p. 73).

## FOLDER NAME

All recorded images are stored in folders on the memory card. Folder names come in two formats, standard and date.

Standard folders have an eight character name. The initial folder is named 100KM033. The first three digits are the folder's serial number, which increases by one each time a new folder is created. The next two letters refer to Konica Minolta, and the last three numbers indicate the camera used; 033 indicates a DiIMAGE X1.

A date folder name also starts with the three digit serial number and is followed by one register for the year, two register for the month, and two registers for the day: 101YMMDD. The folder 10150824 was created in 2005 on August 24th.

With the date folder format selected, when an image is recorded a new folder with the day's date is created. All images recorded that day are placed in that folder. Images recorded on a different day are placed in a new folder with the corresponding date. For more information on folder organization and file names, see page 88.

## DATE AND TIME

The date/time setup screen is opened from section 3 of the setup menu (p. 73). See page 22 for how to set the date and time. Date format also can be changed.

## VIDEO OUTPUT

Camera images can be displayed on a television. The video output can be changed between NTSC and PAL in section 4 of the setup menu (p. 73). North America uses the NTSC standard and Europe uses the PAL standard. Check which standard is used in your region to play back images on your television set.



**100KM033  
(Standard)**



**10150824  
(Date)**

## VIEWING IMAGES ON A TELEVISION

The supplied AV cable is used to view camera images on your television.

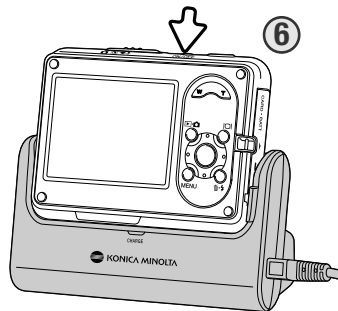
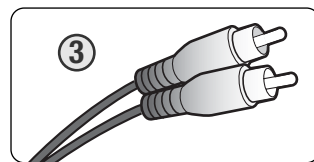
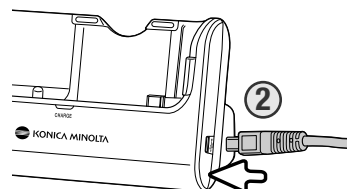

1. Turn off the television and the camera.
2. Insert the small plug of the AV cable into the cradle terminal. Insert the plug in straight, never at an angle. The arrow mark on the plug should face the back of the cradle.
3. Plug the other end of the AV cable into the video and audio input terminals on the television. The yellow plug is for the video output. The white plug is for the monaural audio output.
4. Place the camera in the cradle with the LCD monitor to the front.
5. Turn the television on and change the television to the video channel.
6. Turn the camera on. The playback display is visible on the television screen. The camera's monitors do not activate when the camera is attached to a television.
7. View images as described in the playback section.

When disconnecting, turn off the camera first, remove it from the cradle, and then unplug the AV cable.

Cradle can power the camera. Connect the power cord to the cradle before attaching the AV cable or camera. When disconnecting, unplug the power cord last.

## TRANSFER MODE

The transfer mode must be specified depending on how the camera is to be used with a computer or printer. Two transfer-mode options are available in section 4 of the setup menu (p. 73):

<b>Data storage</b>	To transfer data between the camera and computer. This option must be selected when moving image files to the computer, or using the camera with the Kodak EasyShare or DiMAGE Master Lite software.
<b>PictBridge</b>	To print images with a PictBridge compatible printer.

For more on these options, refer to the data-transfer section of the manual.

## FIRMWARE VERSION

The camera firmware version can be verified in section 4 of the setup menu (p. 73). Firmware is the software that runs the camera. Select the menu option to display the firmware version. Press the center button of the controller to close the window.

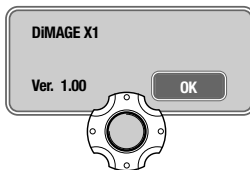

## DATA-TRANSFER MODE

Read this section carefully before connecting the camera to a computer. The DiMAGE manuals do not cover the basic operation of computers or their operating systems; please refer to the manual supplied with your computer.

## SYSTEM REQUIREMENTS

For the camera to be connected directly to the computer and used as a mass-storage device, the computer must be equipped with a USB port as a standard interface. The computer and the operating system must be guaranteed by their manufacturers to support USB interface. The following operating systems are compatible with the camera:

**Windows 98, 98SE, Me, 2000 Professional, and XP Home and Professional editions.**

**Mac OS 9.0 ~ 9.2.2 and Mac OS X 10.1.3 - 10.1.5, 10.2.1 ~ 10.2.8, 10.3 ~10.3.9, 10.4 ~ 10.4.1**

Check the Konica Minolta web site for the latest compatibility information:

North America: <http://kmpi.konicaminolta.us/>

Europe: <http://www.konicaminoltasupport.com/>

USB 2.0 data-transfer speed is full-speed mode (12Mbps); high-speed mode (480Mbps) is not available.

Users with Windows 98 or 98 Second Edition will need to install the driver software on the included Digital Camera Software CD-ROM (p. 85). No special driver software is required for other Windows or Macintosh operating systems.

Customers who have bought a previous Konica Minolta DiMAGE or SLR digital camera and have installed the Windows 98 driver software must repeat the installation procedure. The updated version of the driver software included on the supplied Digital Camera Software CD-ROM is required for the operation of the DiMAGE X1 with a computer. The new software has no effect on the performance of the older cameras.

## CONNECTING THE CAMERA TO A COMPUTER

A fully charged battery should be used when the camera is connected to a computer. The use of cradle to power the camera is recommended over the use of the battery. Before connecting the camera, confirm data storage is selected in the transfer-mode option in section 4 of the setup menu (p. 73).

**For users with Windows 98 or 98SE, read the section on page 85 on how to install the necessary USB driver before connecting the camera to a computer.**

1. Start up the computer. The computer must be turned on before connecting the camera.

2. Plug the power cord into the cradle and a live household outlet (p. 15).

3. Insert the small plug of the USB cable into the cradle terminal. Insert the plug in straight, never at an angle. The arrow mark on the plug should face the back of the cradle. Make sure the plug is firmly attached.

4. Attach the other end of the USB cable to the computer's USB port. Make sure the plug is firmly attached. The cradle should be connected directly to the computer's USB port. Attaching the cradle to a USB hub may prevent the camera from operating properly.

5. With the camera off, place it in the cradle with the LCD monitor to the front. Turn the camera on to initiate the USB connection. While the camera is connected to a computer, the data-transfer screen is displayed.

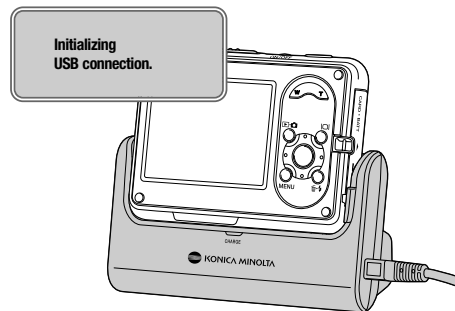
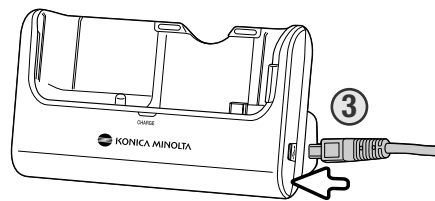

With the camera properly connected to Windows XP or Mac OS X, a window may open to download image data; follow the instructions in the window. A drive icon, or volume, appears in My Computer or the desktop; the name varies with memory card and operating system.

### My Computer: Windows



### Desktop: Mac OS



## CONNECTING TO WINDOWS 98 AND 98SE

The driver needs only to be installed once. If the driver cannot be installed automatically, it can be installed manually with the operating system's add-new-hardware wizard; see the instructions on the following page. During installation, if the operating system requests the Windows 98 CD-ROM, insert it into the CD-ROM drive and follow the accompanying instructions on the screen. No special driver software is required for other Windows operating systems.

### Automatic Installation

Before connecting the camera to the computer, place the Digital Camera Software CD-ROM in the CD-ROM drive. The launcher should automatically activate. To automatically install the Windows 98 USB driver, click on the "Install the Windows 98 USB Mass-Storage Driver" button. A window appears to confirm that the driver should be installed; click "Yes" to continue.

A message appears when the driver has been successfully installed. Click "OK." Restart the computer before connecting the camera (p. 84).

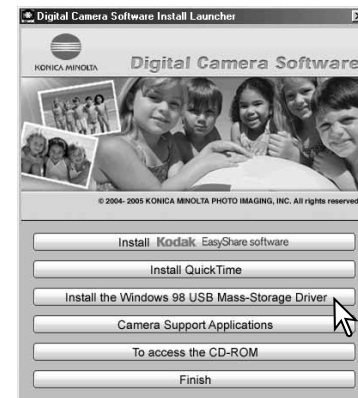

## Manual Installation



To install the Windows 98 driver manually, follow the instructions in the connecting-the-camera-to-a-computer section on page 84.

When the camera is plugged into the computer, the operating system will detect the new device and the add-new-hardware-wizard window opens. Place the Digital Camera Software CD-ROM in the CD-ROM drive. Click “Next.”



Choose the recommended search for a suitable driver. Click “Next.”



Choose to specify the location of the driver. The browse window can be used to indicate the driver location. The driver should be located in the CD-ROM drive at :Win98\USB. When the location is shown in the window, click “Next.”



The add new hardware wizard will confirm the location of the driver. The letter designating the CD-ROM drive will vary between computers. Click “Next” to install the driver in the system.

One of three drivers may be located: MNLVENUM.inf, USBPDR.inf, or USBSTRG.inf.



The last window confirms the driver has been installed. Click “Finish” to close the add new hardware wizard. Restart the computer.

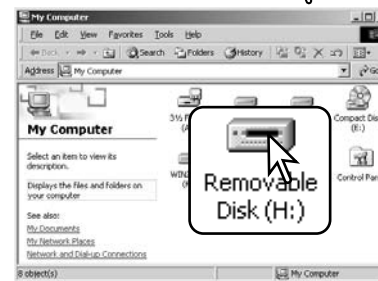

When the my-computer window is opened, a new removable-disk icon is displayed. Double click on the icon to access the camera’s memory card; see page 88.

## FOLDER ORGANIZATION



Drive Icon

Once the camera is connected to the computer, image and audio files can be accessed by double clicking on icons. Image folders are located in the DCIM folder. The misc. folder contains DPOF print files (p. 70). To copy images and audio recordings, simply drag and drop the file icon into a location in the computer.



Dcim



Misc

Files and folders on the memory card can be deleted using the computer. Never format the memory card from the computer; always use the camera for formatting. Only files recorded by the camera should be stored on the memory card.



100KM033



10150801



102KM\_EM

From left to right: standard folder, date folder, and e-mail copy folder.



PICT0001.JPG

JPEG image files



PICT0001.WAV

PICT0001's  
audio-caption file



PICT0002.MOV

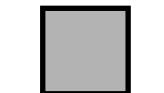

PICT0002.THM

Movie clip



PICT0003.WAV



PICT0003.THM

Audio recording

Image and audio file names begin with "PICT" followed by a four-digit file number and a jpg, or mov extension. Audio-caption files have a wav extension and the file name corresponds to their image file. Audio recordings also use the wav extension. Movie clips and audio-recording files are accompanied by thumbnail (.thm) files. To copy images, simply drag and drop the file icon into a location in the computer.

When a new folder is created, the first three digits in the folder name is one greater than the largest folder number on the card. When the index number in the image file name exceeds 9,999, a new folder is created with a number one greater than the greatest folder number on the card: e.g. from 100KM033 to 101KM033.

The number in the image file name may not correspond to the frame number of the image. The serial numbers used with image files will not change when an image is deleted. When a new image is recorded, it is assigned a number one greater than the largest serial number in the folder. File serial numbers can be controlled with the file-number-memory function in section 3 of the setup menu (p. 73).

## Camera Notes

To view images correctly on your computer, the monitor's color space may need to be adjusted. Refer to your computer manual on how to calibrate the display to the following requirements: sRGB, with a color temperature of 6500K, and a gamma of 2.2.

## DISCONNECTING THE CAMERA FROM A COMPUTER



Never disconnect the camera when the indicator lamp is lit - the data or memory card may permanently be damaged.

### Windows 98 / 98 Second Edition

Confirm that the indicator lamp is not lit. Turn the camera off, remove it from the cradle, and then disconnect the USB cable. If Kodak EasyShare is installed, right click on the EasyShare icon located on the task bar and quit the application before disconnecting the camera.

### Windows XP, 2000 Professional, and Me



To disconnect the camera, click once on the unplug-or-eject-hardware icon located on the task bar. A small window opens indicating the device to be stopped.



Click on the small window to stop the device; the safe-to-remove-hardware message appears. Turn the camera off, remove it from the cradle, and then disconnect the USB cable.



When more than one external device is connected to the computer, repeat the procedure above except right click on the unplug-or-eject-hardware icon to open the unplug-or-eject-hardware window.



The hardware devices connected to the system are displayed. Click the display-device-components check box. Highlight the device to be stopped by clicking on it then click "Stop."



A confirmation screen appears to indicate the devices to be stopped. Clicking "OK" stops the device.



The safe-to-remove-hardware message appears. Turn the camera off, remove it from the cradle, and then disconnect the USB cable.

### Macintosh

Confirm that the indicator lamp is not lit and then drag the mass-storage device icon and drop it into the trash. Turn the camera off, remove it from the cradle, and then disconnect the USB cable.



## CHANGING THE MEMORY CARD - DATA-TRANSFER MODE



Never remove or insert the card when the indicator lamp is lit - the data or memory card may permanently be damaged.

### Windows XP, 2000 Professional, and Me

1. Stop the USB connection using the unplug-or-eject-hardware routine (p. 90).
2. Turn off the camera and remove it from the cradle.
3. Remove, insert, or replace the memory card.
4. Place the camera in the cradle and turn on the camera to remake the USB connection.

### Windows 98 and 98 Second Edition

1. Turn off the camera and remove it from the cradle.
2. Remove, insert, or replace the memory card.
3. Place the camera in the cradle and turn on the camera to remake the USB connection.

If Kodak EasyShare is open, quit the application before turning off the camera.

### Macintosh

1. Stop the USB connection by dragging the drive icon into the trash (p. 91).
2. Turn off the camera and remove it from the cradle.
3. Remove, insert, or replace the memory card.
4. Place the camera in the cradle and turn on the camera to remake the USB connection.

## AUTO POWER SAVE - DATA-TRANSFER MODE

If the camera does not receive a read or write command within ten minutes, it will shut down to save power. When the camera shuts down, an unsafe-removal-of-device warning may appear on the computer monitor. Click "OK." Neither the camera or computer will be damaged in this operation. Unplug the USB cable and turn off the camera. Remake the USB connection by reattaching the cable and turning the camera on.

## REMOVING THE DRIVER SOFTWARE - WINDOWS

1. Connect the cradle to the computer with the USB cable. Place the camera in the cradle. Other devices must not be connected to the computer during this procedure.
2. Right click on the My-computer icon. Select "properties" from the drop-down menu.

Windows XP: from the start menu go to the control panel. Click on the performance and maintenance category. Click "System" to open the system properties window.

3. Windows XP and 2000 Professional: select the hardware tab in the properties window and click the device-manager button.

Windows Me and 98: click the device-manager tab in the properties window.

4. The driver file will be located in the universal-serial-bus-controller or other-devices location of the device manager. Click on the locations to display the files. The driver should be indicated with Konica Minolta, the camera name, or "USB Mass Storage Device." Under certain conditions, the driver name may be different. However, the driver will be indicated by either a question mark or exclamation point.

5. Click on the driver to select it.

6. Windows XP and 2000 Professional: click on the action button to display the drop-down menu. Select "uninstall." A confirmation screen will appear. Clicking "Yes" will remove the driver from the system.

Windows Me and 98: click the remove button. A confirmation screen will appear. Clicking "Yes" will remove the driver from the system.

7. Turn the camera off, remove it from the cradle, and then disconnect the USB cable. Restart the computer.



## PICTBRIDGE

Confirm the transfer-mode option in section 4 of the setup menu is set to PictBridge. Turn on the PictBridge compatible printer. Connect the cradle to the printer using the USB cable; it is recommended to plug in the cradle to power the camera. The larger plug on the cable is connected to the printer. The smaller plug of the cable is inserted into the cradle terminal with the arrow mark facing the back of the cradle. Insert the plug in straight, never at an angle. Place the camera in the cradle and turn it on; the PictBridge screen is displayed automatically.

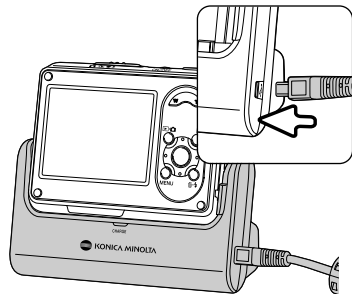

Individual still images can be selected for printing on the PictBridge screen. For other printing options, see the menu navigation section on page 96.

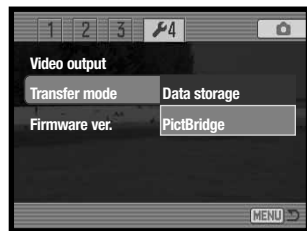

Total number of prints

Number of copies

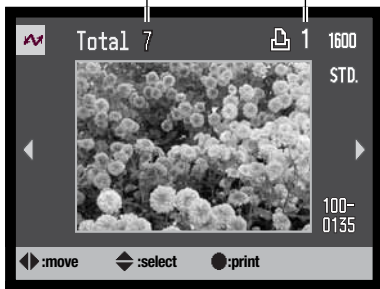

Use the left/right keys of the controller to display the image to be printed.



Press the up key to select the number of copies to be printed. To deselect an image for printing, press the down key until the number of copies reaches zero.



Repeat the previous steps until all the images to be printed are selected. Press the center button of the controller to continue.

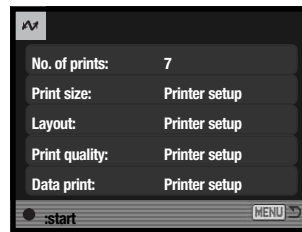

The number of prints in the print run are displayed as well as the print parameters selected with the menu. See the menu navigation section for more information (p. 96). Press the center button of the controller to begin printing, or press the menu button to return to the PictBridge screen. A maximum number of fifty images can be printed.

Once printing begins, the operation can be canceled by pressing the center of the controller. The printing-finished message indicates the end of the operation; turn the camera off to end the routine.

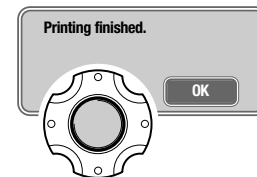

## NOTES ON PRINTING ERRORS

If the battery is exhausted before the print run is complete, printing is canceled. Use a fully-charged battery or plug in the cradle to power the camera. When using the power cord, connect the power cord before attaching cables or camera. When disconnecting, unplug the power cord last.

If a minor problem occurs during printing, such as the paper runs out, follow the procedure recommended for the printer; no action is required for the camera. If a major printer error occurs, press the center button of the controller to end the routine. Refer to the printer manual for the correct procedure for the printer problem. Check the printer settings before starting again and deselect the images that were printed.

## NAVIGATING THE PICTBRIDGE MENU

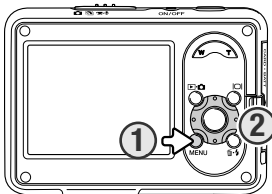

Pressing the menu button (1) turns the menu on and off. The four-way keys of the controller (2) move the cursor in the menu. Pressing the center button of the controller enters a setting. The options that can be changed vary with the printer.



MENU

Activate the menu with the menu button.



Use the left/right keys of the controller to highlight the appropriate menu tab; the menu changes as the tabs are highlighted.



Use the up/down keys to scroll through the menu options. Highlight the option whose setting needs to be changed.



With the menu option highlighted, press the right controller key; the settings are displayed with the current setting highlighted. If “Start” or “Enter” is displayed, press the center button of the controller to continue.



Use the up/down keys to highlight the new setting.



Press the center button of the controller to select the highlighted setting.

Once a setting has been selected, the cursor returns to the menu options and the new setting is displayed. To return to the PictBridge screen, press the menu button. Read the following sections on information on the menu options.

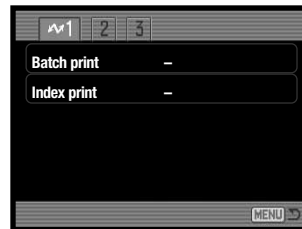

### Index to menu functions

Batch print, 97

Data print, 99

DPOF print, 99

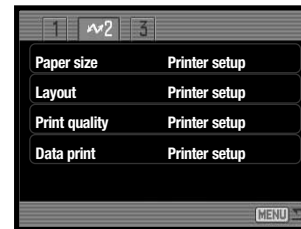

Index print, 97

Layout, 98

Paper size, 98

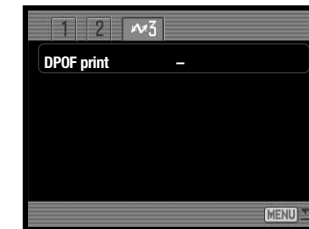

Print quality, 99

### Batch print

Batch print in section 1 selects all still images on the memory card for printing. Two options are available:

**All-frames** - to print all images on the card. A screen opens so the number of copies of each image can be specified. A maximum number of twenty copies and up to fifty images in total can be printed.

**Reset** - to cancel changes made with the batch print option or with the print selection screen.

### Index print

An index print of all still images on the memory card can be made. The quality and size of the print can be specified with the camera menu. The number of images per page varies with the printer. The print-setup confirmation screen is displayed before the print routine starts.

## Paper size

The paper size of the print can be specified in section 2 of the PictBridge menu. The printer setup option uses the size set with the printer.

Highlight the current size setting in the menu and press the center button of the controller to open the paper-size screen.

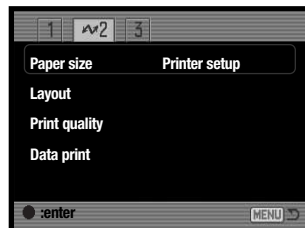

Use the four-way key of the controller to highlight the paper size.

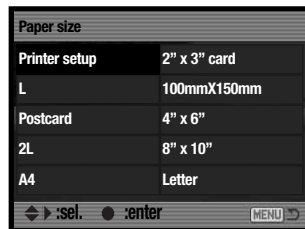

Press the center button of the controller to set the paper size.



## Printing Notes

The following are the dimensions for postcard, L, and 2L paper sizes in both millimeters and inches for your reference:

Postcard	100x148mm	3.9x5.9 in.
L	89x127mm	3.5x5.0 in.
2L	127x178mm	5.0x7.0 in.

## Layout

The layout of the print can be set in section 2 of the PictBridge menu. The printer-setup option uses the layout parameters of the printer. Borderless printing can be specified with the camera as well as the number of images per page.

## Print quality

The print quality can be set in section 2 of the PictBridge menu. The printer-setup option uses the quality set with the printer. The fine quality can be specified with the camera.

## Data print

Data can be printed with the image. The printer-setup option uses the options set with the printer. The date of capture and the file name can be selected for printing. Data printing can also be disabled with the menu.

## DPOF print

DPOF print in section 3 of the PictBridge menu allows still images and an index print selected with the DPOF printing options in section 3 of the playback menu to be printed from a DPOF compatible PictBridge printer. Simply select the start option from the menu to begin the routine.

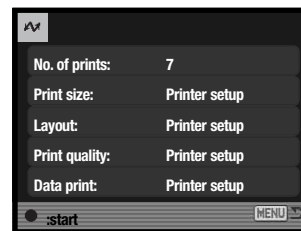

The number of prints in the print run are displayed; an index print is counted as one. Press the center button of the controller to begin printing, or press the menu button to return to the PictBridge menu.

Once printing begins, the operation can be canceled by pressing the center button of the controller. The printing-finished message indicates the end of the operation; press the center button of the controller and turn the camera off to end the routine.

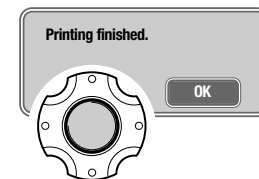

## KODAK EASYSHARE SOFTWARE

The all-in-one digital photography software solution gives you an effortless way to organize, print, and share your pictures.

### Organize your pictures

Kodak EasyShare software automatically organizes your pictures so you can find and view them quickly. Or create custom albums and sort pictures your own way.

### Create beautiful prints

Turn your digital pictures into great prints with no hassles – at home, online, or from your local retailer.

### Share precious memories

Share your favorite pictures with family and friends quickly and simply, right from the software.

### Make the most out of your digital pictures

Make good pictures great with simple-to-use editing tools.

To take advantage of these features, install Kodak EasyShare software on your computer. Kodak EasyShare software is not supplied in all sales regions. The following are the system requirements for Kodak EasyShare software:

<b>Windows 98, 98SE, Me, 2000 Professional with Service Pack 1 or later, XP Home or Professional.</b>	<b>Mac OS X 10.2.3 ~ 10.2.8 or Mac OS X 10.3 ~ 10.3.8.</b>
<b>Apple QuickTime 6</b>	<b>Safari 1.0 or later</b>

If you are running Windows 2000 or Windows XP, you require administrator privileges to install Kodak EasyShare software. A copy of Apple QuickTime 6 is supplied on the Digital Camera Software CD-ROM for Windows operating systems. For more on QuickTime, see page 104. For service and support, visit Kodak at:

[www.kodak.com/go/easysharesupportsw\\_english](http://www.kodak.com/go/easysharesupportsw_english)

**IMPORTANT:** Install the software from the Digital Camera Software CD-ROM before connecting the camera to the computer. Failure to do so may cause the software to install incorrectly.

1. Close all software applications that are open on your computer (including antivirus software).

2. Place the Digital Camera Software CD-ROM into the CD-ROM drive.

3. Install the software:

**Windows OS-based computer** – The launcher appears. Click the install Kodak EasyShare software button to begin the installation routine. If the install window does not appear, see software notes below.

**Mac OS X** – Double-click the CD icon on the desktop and open the Kodak EasyShare folder. Click the Install icon to begin the installation routine.

4. Follow the on-screen instructions to install the software.

**Windows OS-based computer** – On the setup-type screen, select Typical to automatically install all the applications. Select Custom to choose the applications you wish to install.

**Mac OS X** – Follow the on-screen instructions.

5. Restart the computer. If you turned off anti-virus software, turn it back on. See the anti-virus software manual for details.

For information on Kodak EasyShare software, click the Help button in the main window or use the Help drop-down menu.



## Software Notes

If the Windows installer does not start up automatically, initiate the run routine on the start menu. Click the browse button in the run dialog box and select the CD-ROM drive from the look-in box in the browse window. Open the appropriate application and language folders to locate the Setup.exe file. Click on the Setup.exe file to display it in the run dialog box. Click OK.

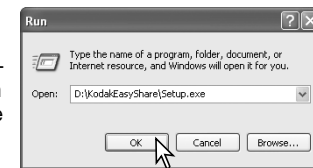

## DIMAGE MASTER LITE

DiIMAGE Master Lite is your entrance into digital imaging.

### Image-processing tools

Color, contrast, saturation, and sharpness can be optimized to bring out the best in your images. Advanced RAW image processing for specific model DiIMAGE cameras ensures high-quality results.

### Image information

Detailed information on how and when the image was recorded as well as file specifications can be viewed.

### Picture editing

Download and sort your images quickly and efficiently on your computer. Collections of images can be displayed automatically as a slide show.

### Color management

The use of monitor and printer ICC profiles allows accurate display and printing of images.

The following are the system requirements for DiIMAGE Master Lite software:

<b>IBM PC/AT compatible computers</b>	<b>Apple Macintosh series computers</b>
<b>Pentium II processor or higher (Pentium III or higher recommended)</b>	<b>PowerPC G3 or higher (PowerPC G4 or higher recommended)</b>
<b>Windows 98, 98SE, Me, 2000 Professional, XP</b>	<b>Mac OS X: 10.1.3 ~ 10.1.5, 10.2.1 ~ 10.2.8, 10.3 ~10.3.9,10.4 ~ 10.4.1</b>
<b>128MB of RAM (256MB or more recommended)</b>	
<b>200MB or more of hard-disk space (100MB or more for installation)</b>	
<b>A 16-bit color monitor with a minimum resolution of 1024 X 768 (XGA) or higher.</b>	
<b>QuickTime 6 or later</b>	

If you are running Windows 2000 or XP, you require administrator privileges to install DiIMAGE Master Lite. Compatibility is with Windows XP Home or Professional editions. Computers with Windows 98 operating systems require Microsoft Internet Explorer 5.0 or later. For more on QuickTime, see page 104.

For a complete description of DiIMAGE Master Lite, refer to the pdf manual on the supplied DiIMAGE Instruction Manual CD-ROM. The manual is located in the manual folder on the CD-ROM and organized in language folders. Copy the file to your computer for reference.

Adobe Reader is required to open the pdf manual. A copy of this software is included on the DiIMAGE Instruction Manual CD-ROM and organized in language folders. Double click on the installer icon and follow the instructions on the installer screens to install the software. The latest version of Adobe Reader can be downloaded at [www.adobe.com](http://www.adobe.com).

1. Close all software applications that are open on your computer including antivirus software.
2. Place the Digital Camera Software CD-ROM into the CD-ROM drive.
3. Install the software:  
**Windows based computer** – The launcher appears. Click the camera support Applications button and then the install DiIMAGE Master Lite button to begin the installation routine. If the launcher does not appear, see software notes on page 101.  
**Mac OS X** – Double-click the CD icon on the desktop, open the Utility folder, the DiIMAGE Master Lite folder, and then the appropriate language folder. Click the Installer icon to begin the installation routine.
4. Follow the on-screen instructions to install the software. Refer to the Master Lite pdf instruction manual for detailed installation and operation instructions.
5. If you turned off anti-virus software, turn it back on. See the anti-virus software manual for details.

The full version of DiIMAGE Master gives you all the tools to organize, examine, and process your images as well as sophisticated tools for RAW processing. For more on DiIMAGE Master, visit us on the web at:

North America: <http://kmpi.konicaminolta.us/>  
Europe: <http://www.konicaminoltasupport.com>

## QUICKTIME SYSTEM REQUIREMENTS

<b>IBM PC / AT Compatible</b>
<b>Pentium processor-based PC or compatible computer</b>
<b>Windows 98, Me, 2000, or XP.</b>
<b>128MB or more of RAM</b>

To install QuickTime, follow the instructions in the installer. QuickTime is not supplied with the camera in all sales regions. Users can download the latest version of QuickTime free of charge from the Apple Computer web site: <http://www.apple.com>.

## APPENDIX TROUBLESHOOTING

The section covers minor problems with basic camera operation. For major problems or damage, or if a problem continues to reoccur frequently, contact our service facility.

Problem	Symptom	Cause	Solution
The camera will not work.	Nothing displayed on the monitors.	The batteries are dead.	Recharge batteries (p. 17).
Shutter will not release.	Card-full warning appears on the monitor.	Memory card is full and unable to store an image at the image-quality or image-size setting on the camera.	Insert a new memory card (p. 20), delete some images (p. 34, 64), or change the image-quality or image-size setting (p. 44).
	Card-locked warning appears on the monitor.	Memory card is locked.	Unlock the memory card using the write-protect switch (p. 108).
Pictures are not sharp.	Pictures are taken in low-light situations without flash.	Slow shutter speeds result in blurred images when the camera is hand-held.	Use a tripod, change the camera sensitivity to a higher setting (p. 48), or use the flash (p. 28).

Problem	Symptom	Cause	Solution
Pictures are not sharp.	Focus signal is red.	Subject is too close.	Make sure the subject is within the autofocus range (p. 26) or use the Super Macro (p. 31).
		A special situation is preventing the autofocus system from focusing (p. 27).	Use the focus-lock function to focus on an object at the same distance as the subject (p. 26).
While using flash, the pictures are too dark.	The subject is beyond the flash range (p. 29, 49).		Move closer to the subject or change the camera sensitivity to a higher setting (p. 48).
The rate of capture is very slow.	Processing message may appear.	Noise reduction is being applied to the image data because of slow shutter speeds.	Use flash or shoot under brighter conditions.
Occasionally the camera does not turn off immediately.	The monitor is blank and the indicator lamp blinks.	The CCD is being calibrated. Do not remove the battery during calibration. This is not a defect and the camera turns off automatically.	

If the camera does not function normally, turn it off, remove and reinsert the battery, or unplug and reconnect the AC adapter set. Always turn the camera off using the main switch otherwise the memory card may be damaged and camera settings reset.

## ABOUT THE CRADLE POWER CORD

The AC cord is designed for the current of the sales region. Only use the cord in the region it was purchased.

Region	Product code
Continental Europe, Korea, Singapore (220-240V)	APC-150
China (220-240V)	APC-151
Great Britain, Hong Kong (220V-240V)	APC-160
United States, Canada, Taiwan, Japan (100V-120V)	APC-170
Australia, New Zealand (220-240V)	APC-230

## CARE AND STORAGE

Read this section in its entirety to get the best results from your camera. With proper care, your camera will provide years of service.

### Camera care

- Do not subject the camera to shock or impact.
- Turn off the camera when transporting.
- This camera is neither waterproof nor splashproof. Inserting or removing batteries or the memory card, or operating the camera with wet hands may damage the camera.
- When at the beach or near water, take care not to expose the camera to water or sand. Water, sand, dust, or salt can damage the camera.
- Do not leave the camera under direct sunlight. Do not point the lens directly at the sun; the CCD may be damaged.
- Keep the camera away from strong electromagnetic fields from objects such as magnets or motors.

### Cleaning

- If the camera or the outside of the lens is dirty, gently wipe it with a soft, clean, dry cloth. If the camera or lens comes in contact with sand, gently blow away loose particles. Wiping may scratch the surface.
- To clean the lens surface, first blow away any dust or sand, then gently wipe the lens with a cloth or tissue designed for optics. Use lens-cleaning fluid if necessary.
- Never use organic solvents to clean the camera.
- Never touch the lens surface with your fingers.

### Storage

- Store in a cool, dry, well-ventilated area away from dust and chemicals. For long periods of disuse, store the camera in an airtight container with a silica-gel drying agent.
- Remove the batteries and memory card from the camera when not in use for extended periods.
- Do not store the camera in an area with naphthalene or mothballs.
- During long periods of storage, operate the camera occasionally. When taking the camera out of storage, check that the camera is functioning properly before using.

### Batteries

- Battery performance decreases with temperature. In cold environments, we recommend keeping spare batteries in a warm place, such as the inside of a coat. Batteries can recover their power when they warm up.
- Do not store the battery when it is fully charged.
- When storing the battery for extended periods, recharge it for five minutes every six months. The battery may not be able to be charged if completely exhausted.
- A special built-in battery supplies power to the clock and memory for approximately one month when the camera battery is exhausted or removed. If the camera resets each time the battery is replaced, the built-in battery is exhausted. It must be replaced at a Konica Minolta service facility.
- After initially inserting a charged battery, do not remove it from the camera for 24 hours; the camera can be off during this period. The main battery is used to charge an internal battery, which protects settings when the main battery is removed.
- Keep battery and camera cradle contacts clean. Dirty contacts can prevent charging. If the contacts become dirty, wipe them with a cotton swab.

## Memory cards

SD Memory Cards and MultiMediaCards are manufactured with precision electronic components. The following may cause data loss or damage:

- Improper use of the card.
- Bending, dropping, or subjecting the card to impact.
- Heat, moisture, and direct sunlight.
- Static electrical discharge or electromagnetic fields near the card.
- Removing the card or interrupting the power supply while the camera or a computer is accessing the card (reading, writing, formatting, etc.).
- Touching the electrical contacts of the card with your fingers or metal objects.
- Using the card beyond its life. Purchasing a new card periodically may be necessary.

The response time during recording and playback is longer with MultiMediaCards compared with SD Memory Cards. This is not a defect, but rather due to the specifications of the cards. When using large capacity cards, some operations like deletion may take longer.

The SD Memory Card has a write-protect switch to prevent image data from being deleted. By sliding the switch to the bottom of the card, the data is protected. However, when the card is protected, images cannot be recorded. If an attempt is made to record or delete an image with the camera, the card-locked message appears on the LCD monitor.

Memory cards should not be used to permanently store image data. Always make a copy of camera files on an appropriate storage device or recording media. Konica Minolta has no responsibility for any loss or damage to data.

## Before important events and journeys

- Check the camera's operation; take test pictures and purchase spare batteries.
- Konica Minolta has no responsibility for any damage or loss incurred by equipment malfunction.

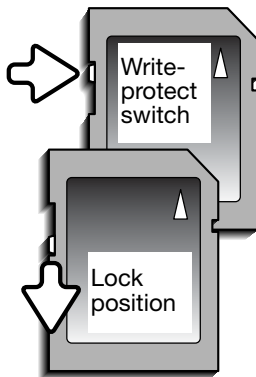

## Operating temperatures and conditions

- This camera has been designed for use in temperatures from 0°C to 40°C (32°F to 104°F).
- Never leave the camera exposed to extreme high temperatures, such as in a car parked in the sun, or to extreme humidity.
- When taking the camera from a cold to a warm environment, place it in a sealed plastic bag to prevent condensation from forming. Allow the camera to come to room temperature before removing it from the bag.

## LCD monitor care

- The LCD monitor is manufactured using high-precision technology and more than 99.99% of the pixels operate properly. Less than 0.01% of the monitor pixels are displayed as color or bright points; this is not a monitor defect and does not affect the recorded image.
- Do not apply pressure to the surface of the LCD monitor; it may be permanently damaged.
- In cold temperatures, the LCD monitor may become temporarily dark. When the camera warms up, the display will function normally.
- If fingerprints are on the LCD monitor surface, gently wipe with a soft, clean, dry cloth.

## Copyright

- TV program, films, video tapes, photographs, and other materials may be copyrighted. Unauthorized recording or duplication of such material may be contrary to copyright laws. Taking pictures or images of performances, exhibitions, etc., is prohibited without approval and can infringe on copyright. Images protected by copyright can only be used under the provisions within the copyright laws.

## Questions and service

- If you have questions about your camera, contact your local camera dealer or write to the Konica Minolta distributor in your area.
- Before shipping your camera for repair, please contact a Konica Minolta service facility.



## TECHNICAL SPECIFICATIONS

Number of effective pixels:	8.0 million
CCD:	1/1.8-type interline primary-color CCD with a total of 8.3 million pixels.
Camera sensitivity (ISO):	Automatic (between ISO 50 - 160 equivalent) Manual: ISO 50, 100, 200
Aspect ratio:	4:3
Lens construction:	12 elements in 10 groups
Maximum aperture:	f/3.5 - f/3.8
Focal length:	7.7 - 23.1 mm (35mm equivalent: 37 - 111 mm)
Focusing range:	At wide-angle position: 0.1m (4 in.) - infinity At telephoto position: 0.4m (16 in.) - infinity 0.05m (2 in.) - infinity in Super Macro mode.
Autofocusing system:	Video AF
Shutter:	CCD electronic shutter plus mechanical shutter
Shutter speeds:	1 - 1/1250s
Flash recycling time:	Approximately 6 seconds
Monitor LCD:	2.5 inch low-temperature polysilicon TFT color
Monitor field of view:	Approximately 100%
A/D conversion:	12 bits
Recording media:	SD Memory Cards, MultiMediaCards
File formats:	JPEG, motion JPEG (MOV), WAV, DCF 2.0, DPOF, and Exif 2.2 compliant.
Print Image Matching III:	Yes
Menu languages:	English, German, French, Spanish, Italian, Swedish, Russian, Japanese, Korean, and Chinese (Simplified and Traditional).
Battery:	Konica Minolta NP-1 lithium-ion battery.
Battery performance (recording):	Approximately 150 frames: based on the CIPA (Camera & Imaging Products Association) standard: NP-1 lithium-ion battery, 3264x2448 image size, standard image quality, no instant playback, flash used with 50% of the frames.
Battery performance (playback):	Approximate continuous playback time: 140 min.: NP-1 lithium-ion battery.
External power source:	Optional AC Adapter Set AC-402/502

Dimensions:	95 (W) x 68 (H) x 19.5 (D) mm 3.7 (W) x 2.7 (H) x 0.77 (D) in. (not including protrusions)
Weight:	Approximately 135 g / 4.8 oz. (without battery or memory card)
Operating temperature:	0° - 40°C
Operating humidity:	5 - 85% (noncondensing)

Lithium-ion Battery NP-1	
Voltage:	3.7V
Weight:	18g / 0.63oz.
Dimensions	36.5 (W) x 40.5 (H) x 6.5 (D) mm 1.43 (W) x 1.59 (H) x 0.26 (D) in.

Cradle CA-1	
Input voltage:	AC100-240V, 50/60Hz
Weight:	100g / 3.5oz.
Dimensions	109 (W) x 62 (H) x 48 (D) mm 4.29 (W) x 2.44 (H) x 1.89 (D) in.

Specifications are based on the latest information available at the time of printing and are subject to change without notice.



For EU member states only

This symbol means: Do not dispose of this product together with your household waste.

Please refer to the information of your local community or contact our dealers regarding the proper handling of end-of-life electric and electronic equipment. Recycling of this product will help to conserve natural resources and prevent potential negative consequences for the environment and human health caused by inappropriate waste handling.



