

# **E** INSTRUCTION MANUAL

**DYNAX**  
*500si*

**MAXXUM**<sup>®</sup>  
*400si*  
*RZ430si*

PREPARATIONS 

FULL-AUTO  
OPERATION 

SUBJECT  
PROGRAM MODE 

CREATIVE  
EXPOSURE MODE 

FOCUS DETAILS 

FLASH DETAILS 

ADDITIONAL 

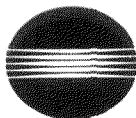

MINOLTA

## IMPORTANT INFORMATION

This camera is designed to work specifically with lenses, flash units, and other accessories manufactured and distributed by Minolta. We therefore caution users of this camera that the attachment and/or use of incompatible products may result in unsatisfactory performance or damage to the camera or its accessories.

To obtain optimum performance throughout the life of your camera, we recommend that you use only those lenses, flashes, and other accessories distributed by Minolta specifically for use with this camera.

This device complies with Part 15 of the FCC Rules. Operation is subject to the following conditions: (1) This device may not cause harmful interference, and (2) this device must accept any interference received, including interference that may cause undesired operation. Changes or modifications not approved by the party responsible for compliance could void the user's authority to operate the equipment. This equipment has been tested and found to comply with the limits for a Class B digital device, pursuant to Part 15 of the FCC Rules. These limits are designed to provide reasonable protection against harmful interference in a residential installation. This equipment generates, uses and can radiate radio frequency energy and, if not installed and used in accordance with the instructions, may cause harmful interference to radio communications. However, there is no guarantee that interference will not occur in a particular installation. If this equipment does cause harmful interference to radio or television reception, which can be determined by turning the equipment off and on, the user is encouraged to try to correct the interference by one or more of the following measures:

- Reorient or relocate the receiving antenna.
- Increase the separation between the equipment and receiver.
- Connect the equipment to an outlet on a circuit different from that to which the receiver is connected.
- Consult the dealer or an experienced radio/TV technician for help.

This digital apparatus does not exceed the Class B limits for radio noise emissions from digital apparatus as set out in the Radio Interference Regulations of the Canadian Department of Communications.

## FOREWORD

As you use this camera, you may find something extraordinary. You may very well find your photography improving and your interest in photography increasing.

If you are a beginning photographer, start with Full-Auto mode and observe the camera at work as you move from one subject to another. When you feel comfortable with the camera, select a Subject Program and move one step deeper into the realm of camera control. Notice how different exposure settings affect the end result and how the different effects are best suited to different subjects. The next step is for you to take full creative control of your camera by controlling the shutter speed or aperture or both to obtain the kind of image that you see only in your own mind.

Before you begin using your camera, however, take a moment to familiarize yourself with the contents of this manual. It contains all the information you will need to operate your camera for a lifetime of photography. Read it carefully, refer to it whenever necessary, and you will soon be on your way to beginning or continuing your fascinating experiences in photographing the world around you.

### NOTE

In this manual, a display or indicator surrounded by radiating lines is blinking.

 Steady

 Blinking

This manual contains information regarding products introduced before August, 1994. To obtain compatibility information for products released after this date, contact the authorized MINOLTA Service Facility nearest you.

# TABLE OF CONTENTS

## NAMES OF PARTS

Camera Body .....	4
Body Data Panel .....	6
Viewfinder .....	7

## PREPARATIONS

Standard Accessories .....	8
Neckstrap .....	8
Eyepiece Cap .....	8
Battery .....	9
Installation .....	9
Cautions .....	9
Indicators .....	10
Performance .....	11
Lens .....	12
Attaching .....	12
Removing .....	13
Care .....	13
Film .....	14
Speed .....	14
Loading .....	14
Rewind .....	16

## FULL-AUTO OPERATION

Taking a Picture in Full-Auto Mode .....	18
Focus Notes .....	20
Flash Notes .....	20

## SUBJECT PROGRAM SELECTION

Portrait .....	22
Landscape .....	23
Close-up .....	24
Sports Action .....	25
Night Portrait .....	26

## CREATIVE EXPOSURE SELECTION

A Mode .....	28
Aperture Control .....	29
S Mode .....	30

Shutter Speed Control .....	31
M Mode .....	32
Exposure Control .....	33
Bulb .....	34
Flash and Creative Exposure Modes .....	35

## **FOCUS DETAILS**

Focus Signals .....	37
Special Focusing Situations .....	38
Focus Lock .....	39
Manual Focus .....	40
AF Illuminator .....	41

## **FLASH DETAILS**

Flash Signals .....	43
Built-in Flash .....	44
Flash Range .....	45
Red-Eye Reduction .....	46
Manual Fill-Flash .....	47
Wireless/Remote Flash Control .....	48
Wireless/Remote Ratio Flash .....	52
Canceling Wireless/Remote Flash .....	52

## **ADDITIONAL FEATURES**

Self-Timer .....	54
Program Re-Set Button .....	55
Continuous Film Drive .....	56
Exposure Compensation .....	57

## **APPENDIX**

Camera Shake Warnings .....	59
Exposure Warnings .....	60
Trouble Shooting .....	61
Caring for Your Camera .....	62
Technical Details .....	64
Accessory Information .....	66
Quick Reference Guide .....	67

## NAMES OF PARTS

### CAMERA BODY

For more information on specific parts, refer to the page number in parentheses.

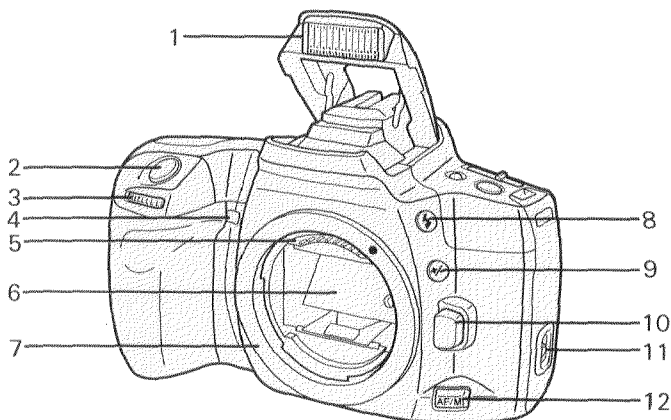

- |                           |                                      |
|---------------------------|--------------------------------------|
| 1. Built-in flash (44)    | 8. Flash-control button (47)         |
| 2. Shutter-release button | 9. Exposure-compensation button (57) |
| 3. Control dial           | 10. Lens-release button              |
| 4. Self-timer lamp (54)   | 11. Back cover release               |
| 5. Lens contacts*         | 12. Focus-mode button (40)           |
| 6. Mirror*                |                                      |
| 7. Lens mount             |                                      |

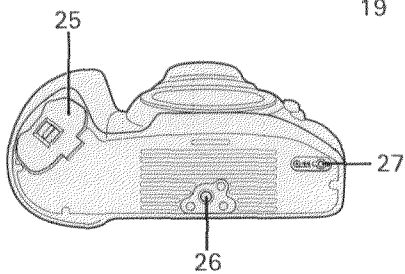
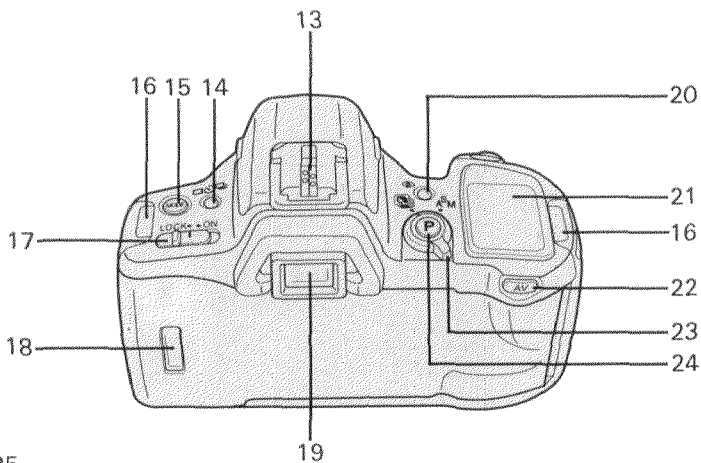

- 13. Accessory shoe
- 14. Drive-mode/self-timer button  
(54, 56)
- 15. Mode button
- 16. Strap eyelet (8)
- 17. Main switch
- 18. Film window

- 19. Viewfinder eyepiece\*
- 20. Flash-mode button  
(46, 49)
- 21. Body data panel
- 22. Aperture button (32)
- 23. Command switch
- 24. Program re-set button (55)
- 25. Battery cover
- 26. Tripod socket
- 27. Rewind button (16)

\*Do Not Touch

# NAMES OF PARTS

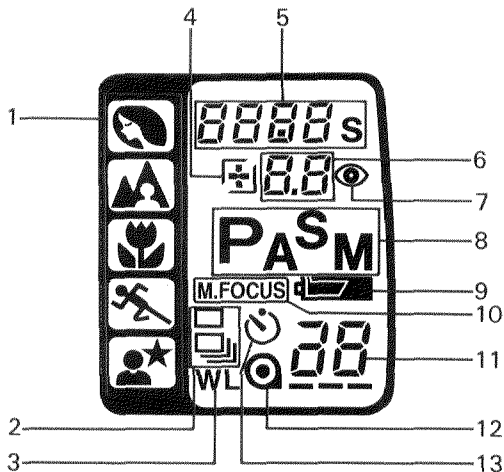

## BODY DATA PANEL



### 1. Subject Program indicators:

-  Portrait
-  Landscape
-  Close-up
-  Sports action
-  Night portrait

### 2. Drive mode indicators:

-  Single-frame advance
-  Continuous drive

### 3. Wireless/Remote flash indicator

### 4. Exposure compensation indicator

### 5. Shutter speed display

### 6. Aperture/Exposure-compensation display

### 7. Red-eye reduction indicator

### 8. Exposure-mode indicators

### 9. Battery condition indicators

### 10. Manual-focus indicator

### 11. Frame counter

### 12. Film-cartridge mark

### 13. Self-timer indicator



## VIEWFINDER

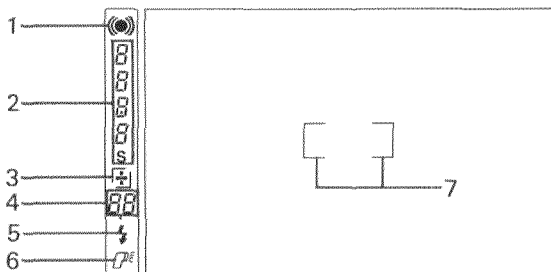

1. Focus signals
2. Shutter speed display
3. Exposure-compensation indicator
4. Aperture/Exposure-compensation display
5. Flash-ready indicator
6. Flash-on indicator
7. Focus frame

## STANDARD ACCESSORIES

### NECKSTRAP

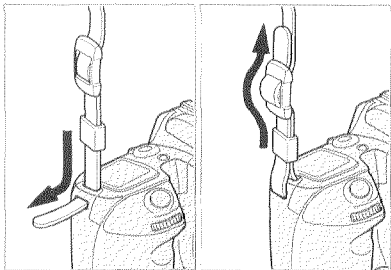

Attach the neckstrap as shown.

### EYEPiece CAP

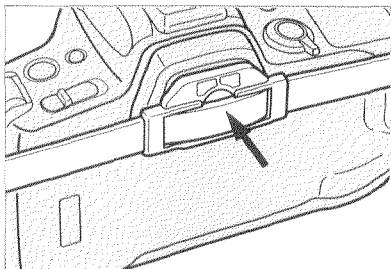

An eyepiece cap is attached to the neckstrap. When you use the self-timer or take a long exposure, snap it over the eyepiece as shown above. This will prevent light from entering the camera through the eyepiece and affecting the metered exposure.

- Kits with a wide strap do not include an eyepiece cap. See your local Minolta dealer to order an accessory eyepiece cap.

## BATTERY

Your camera uses a 6-volt 2CR5 lithium battery which supplies power for all camera operations. If you are using an xi-Series lens, the camera battery also supplies power to the zoom motor in the lens.

### BATTERY INSTALLATION

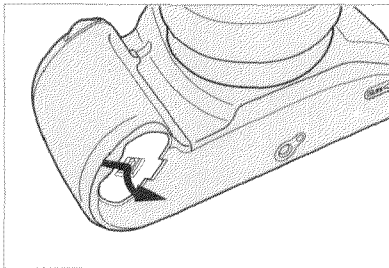

1. Set the main switch to LOCK and slide the battery-cover release in the direction indicated to open the battery cover.

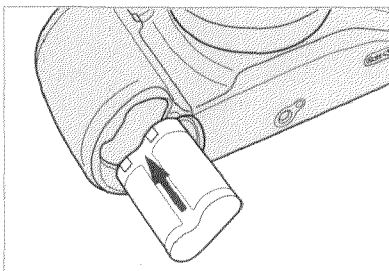

2. Insert the battery according to the marks on the inside of the cover.

3. Close the cover securely.

### CAUTION

- Read and follow all warnings and instructions supplied by the battery manufacturer.
- The battery may explode and cause severe burns if you subject it to high temperatures or fire, or attempt to disassemble, recharge, or short-circuit it.
- Keep batteries away from small children.

# BATTERY

## BATTERY-CONDITION INDICATORS

Whenever you slide the main switch from LOCK to ON, one of the following indicators will appear in the body data panel.

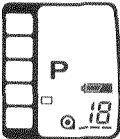
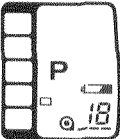
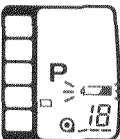
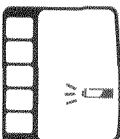
	<p>Full-battery symbol — power is sufficient for all camera operations.</p>
	<p>Low-battery symbol — power is sufficient, but getting low. Keep a fresh battery handy.</p>
	<p>Blinking low-battery symbol appears with other displays — camera can be operated, but power is extremely low. The battery will need to be changed soon.</p>
	<p>Blinking low-battery symbol appears by itself and the shutter locks — power is insufficient for operation. Replace the battery.</p>

- If no displays appear, replace the battery or check that it is inserted correctly.

## BATTERY PERFORMANCE

The battery's performance will depend greatly on how often you use the built-in flash and the temperature in which you use the camera.

Flash Use	-20°C (-4°F)	20°C (68°F)
100%	5 rolls	13 rolls
50%	10 rolls	20 rolls
0%	20 rolls	50 rolls

The above figures are based on the following test conditions: Using 24-exposure rolls and AF 28-80mm f/4-5.6 lens; autofocus from infinity to minimum focus distance and back 3 times; shutter-release button held partway down for 10 seconds before shutter release.

- If you perform more operations during use, battery performance will be slightly lower.
- For performance with 36-exposure rolls, reduce above data by approximately 1/3.
- To maximize battery performance, slide the main switch to LOCK when you are not using the camera.

## COLD-WEATHER OPERATION

Lithium batteries provide excellent performance in cold weather. However, if you plan to shoot many rolls of film in temperatures near or below 0°C (32°F), we recommend that you carry the camera inside your coat while you are not shooting to keep it warm. You should also carry several spare batteries in your pocket so that you can change the camera battery if necessary. Do not discard a cold battery. After it warms up, it will regain some of its charge.

# LENS

## ATTACHING

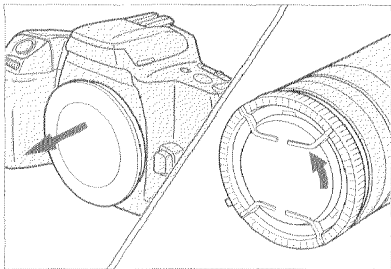

1. Remove the camera's body cap and the rear lens cap as shown.

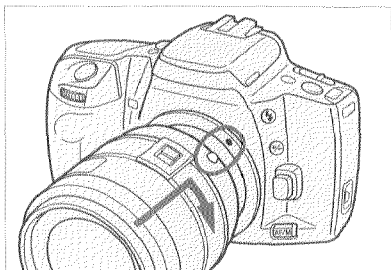

2. Align the red bead on the lens barrel with the red dot on the camera's lens mount.

3. Gently fit the lens into the mount and turn the lens clockwise until it locks firmly in place.

### BE CAREFUL

- Do not force the lens if it does not turn smoothly.
- Never touch anything inside the camera, especially the lens contacts and mirror.

If two lines appear in the aperture display of the camera's body data panel when you press the shutter-release partway down, no lens data is being received by the camera. Some possible causes of this are:

- No lens is attached to the camera
- The lens is not attached properly
- The lens contacts are dirty
- You have attached a non-compatible lens

## REMOVING

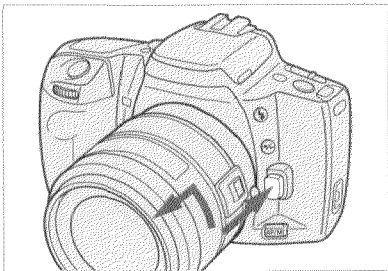

1. Press the lens release button and hold it while you turn the lens counter-clockwise until it stops.
2. Gently remove the lens from the mount.
3. Immediately attach the rear cap to the lens and the body cap or another lens to the camera.

## CARE OF GLASS SURFACES

- Never touch any lens surfaces (including the viewfinder eyepiece) with your fingers. If your lens is dirty, first gently clean it with a lens brush to remove loose material. Then, if necessary, moisten a sheet of lens tissue with one drop of lens-cleaning fluid and, starting from the center of the lens, gently wipe the glass using a circular motion.
- Never lift the mirror inside the camera or touch its surface. This may impair its alignment or scratch its face. Dust on the mirror's surface will not affect meter readings or picture quality. If it is distracting, have your camera cleaned at an authorized MINOLTA Service Facility.

# FILM

## FILM SPEED

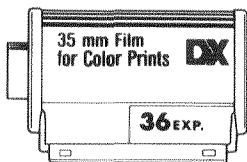

Use DX-coded films, ISO 25 - 5000. DX-coding is a system which the camera uses to automatically identify the film you have loaded. You can recognize DX-coded film by the **DX** printed on the cartridge and box and by the black-and-silver pattern on each cartridge.

The camera reads information encoded on this pattern and sets the film speed automatically each time you insert a new roll of film. If you use non-DX-coded film, the camera automatically sets the film speed to 100.

- Do not touch the contacts inside the film chamber.

## LOADING FILM

Before you load film, check the film window on the back of the camera. If there is already film in the camera, **do not open the back cover**. See page 16 for instructions on rewinding an unfinished roll of film.

- Always load film in subdued light or shade.

### BE CAREFUL

- **NEVER TOUCH THE SHUTTER CURTAIN WITH YOUR FINGERS OR WITH THE FILM TIP.** Its precision design makes it extremely sensitive to pressure.
- If the film tip is bent or torn, the film may not wind correctly.

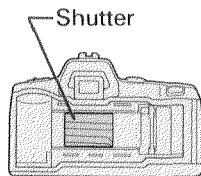



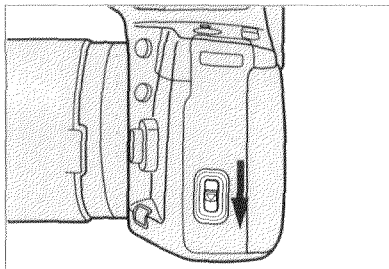

1. Open the back cover by sliding the back-cover release down.

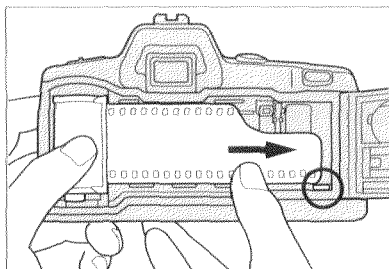

2. Place the film cartridge in the film chamber flat side up and extend the film tip to the red mark.

- If the film tip extends beyond the mark, gently push the excess film back into the cartridge.

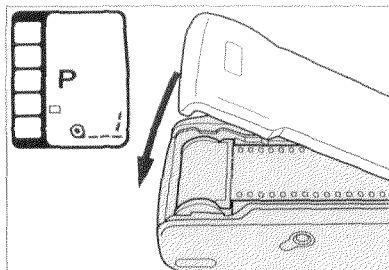

3. Close the back cover and slide the main switch to **ON**. The camera will automatically advance the film to the first frame and 1 will appear in the frame counter.

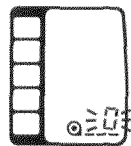

- If the film is loaded incorrectly, **O** will blink in the frame counter and the shutter will remain locked. Open the back cover and repeat steps 2 and 3.

- For flash pictures, use film between ISO 25 and 1000.

## FILM

### REWINDING FILM

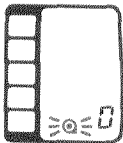

After you have exposed the last frame, the camera will automatically rewind the film. With a fresh battery, it takes about 21 seconds to rewind a 36-exposure roll, or 16 seconds for a 24-exposure roll. When the film has been completely rewound, the motor will stop and the film-cartridge symbol in the body data panel will blink to indicate that it is safe to open the back cover.

#### **To begin film rewind manually:**

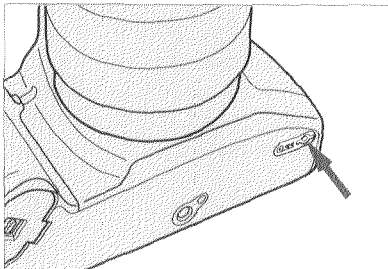

Use a coin or similar object to press the rewind button on the bottom of the camera. Wait until the motor stops and the film cartridge mark blinks before opening the back cover.

# FULL-AUTO OPERATION

Full-Auto mode is the camera's standard operating mode and is suited for use in virtually any situation. In this mode, the camera will focus automatically, set the best shutter speed and aperture, and determine when flash is necessary. Use Full-Auto mode when you are just starting out, when you cannot decide which Subject Program to use, or when you are photographing in quick-changing conditions that would require you to constantly adjust the shutter speed and/or aperture.

## 1. TURN THE CAMERA ON, PRESS THE PROGRAM RE-SET BUTTON, AND RAISE THE FLASH.

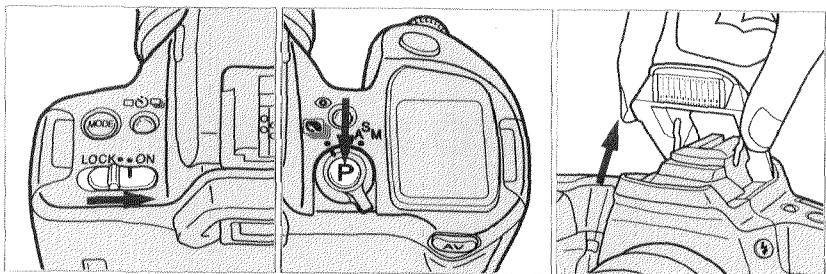

- Pressing the program re-set button restores many of the camera's functions to their standard settings. See page 55 for more information.
- When the built-in flash is up, it will fire whenever necessary in Full-Auto mode. See page 20 for more information.

## 2. HOLD THE CAMERA WITH BOTH HANDS.

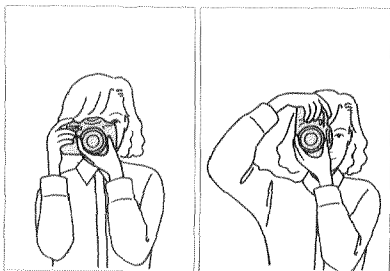

Hold the grip firmly in your right hand and use your left hand to support the camera or lens from beneath. Keep your elbows securely against your sides when shooting both horizontal and vertical pictures. This will help steady the camera and reduce blur in your pictures.

- Always keep the camera strap around your neck for safety.

### 3. LOOK THROUGH THE VIEWFINDER AND FOCUS ON YOUR SUBJECT.

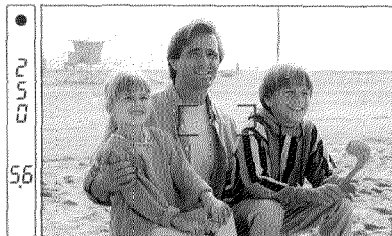

Place your subject inside the focus frame and press the shutter-release button partway down to activate autofocus.

- Do not touch the focusing ring of an AF lens or the end of the lens barrel of an xi-Series Autozoom lens while the lens is focusing.

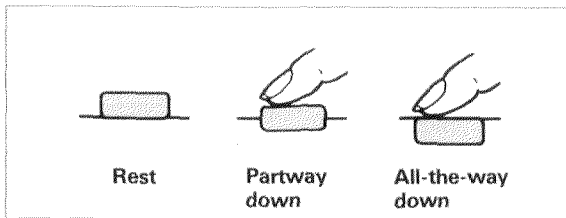

### 4. TAKE THE PICTURE.

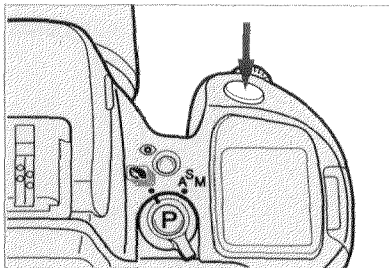

When the focus-lock signal ● appears in the viewfinder data panel, press the shutter-release button all the way down. Press the shutter-release button gently with a single, steady motion — never with a quick jab. This will prevent the camera from moving suddenly at the last moment.

## FOCUS NOTES

When you press the shutter-release button partway down in STEP 3, auto-focus will activate and the viewfinder data panel will light. The camera's auto-focus system will then lock focus on the subject in the focus frame if it is stationary, or will automatically track a moving subject until you press the shutter-release. In Full-Auto mode, there are two focus signals you should know. For more information on these and other focus signals, see page 37.

- (●●) When either of these symbols appear, you can take the picture.
  - ☉ ( ) When either of these symbols appear, the shutter will lock.
- To place your subject outside the focus area, see page 39.

## FLASH NOTES

In Full-Auto mode, the following flash signals will appear in the viewfinder data panel. For more information on these signals, see page 43.



When this symbol blinks, flash is necessary. Raise the camera's built-in flash. When it lights steadily, the flash will fire the next time you take a picture.



When this symbol appears, the flash is charged and you can take a picture. The shutter will lock until it appears to prevent accidental under exposure.

# SUBJECT PROGRAM SELECTION

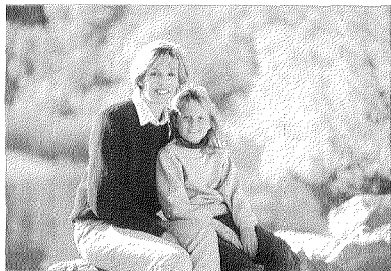

In any of the five subject programs, the camera will, as in *Full-Auto mode*, do everything from focus automatically to select the shutter speed and aperture which is best suited for your subject. By using *Subject Program mode* you take control of an important part of the automatic process and tell the camera from the beginning what kind of picture you will take: a portrait, a landscape, a close-up, sports action, or a portrait at night. For information on P mode, refer to “*Full-Auto Operation*” beginning on page 17.

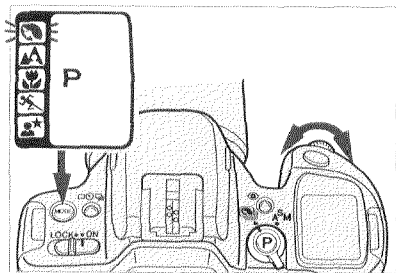

Photographs of people usually benefit from shallow depth of field (the distance in front and behind the point on which you focus which also appears sharp) to isolate the subject from the background. In portrait mode, the camera will make all the settings necessary to obtain this effect, leaving you free to concentrate on composition and capturing the perfect moment or expression.



### To select Portrait mode:

1. Set the Command switch to .
2. Press and hold the Mode button and turn the control dial until  blinks.
3. Release the Mode button.

## RECOMMENDED LENSES

- Use a telephoto lens or the telephoto setting on your zoom lens to enhance the separation between your subject and the background.

## USING FLASH

- Raise the built-in flash only if the background is much brighter than your subject or if there are strong shadows across your subject's face. If you use flash, however, it may not be possible for the camera to obtain shallow depth of field.

## ADDITIONAL SUGGESTIONS

- Lock focus on your subject's eyes.
- Be ready to capture subtle changes in expression after you take the first picture.





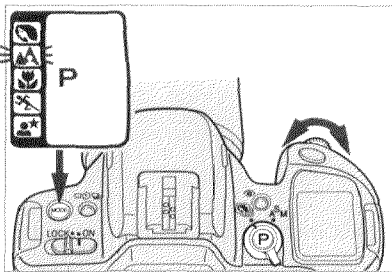

In a landscape photograph, the subject generally extends from near to far. For this reason, a small aperture is necessary to provide maximum depth of field and capture as much of the scene as possible in sharp focus. When set to Landscape mode, the camera will automatically set the smallest aperture possible without introducing the blurring effects of "camera-shake" (see p.59).



### To select Landscape mode:

1. Set the Command switch to .
2. Press and hold the Mode button and turn the control dial until  blinks.
3. Release the Mode button.

## RECOMMENDED LENSES

- Use wide-angle lenses or the wide-angle setting of your zoom lens. This will help create a feeling of depth that will enhance your landscape photographs.

## USING FLASH

- Flash is not recommended in Landscape mode because your subject will usually be outside of flash range.
- When you photograph a person in front of a landmark or scenic landscape, flash will help only if the sun is behind the person.

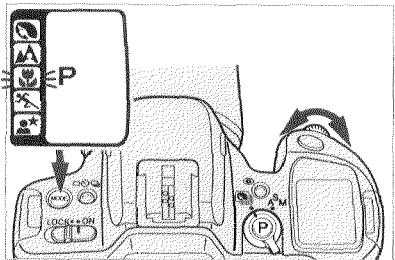

## ADDITIONAL SUGGESTIONS

- Use a tripod to obtain the sharpest possible results.



When you take pictures of small objects such as flowers or models, set Close-up mode. In Close-up mode, the camera will automatically set the best possible aperture and shutter speed for the picture you are taking.

#### To select Close-up mode:

1. Set the Command switch to .
2. Press and hold the Mode button and turn the control dial until  blinks.
3. Release the Mode button.

### RECOMMENDED LENSES

- Use a macro lens (50mm f/2.8 Macro or 100mm f/2.8 Macro) or a macro-capable zoom lens.
- Read your lens owner's manual before taking close-up photographs.

### USING FLASH

- The built-in or an accessory flash may not be suitable for close-up photography. Refer to your flash manual or pp.44, 45 of this manual for more information.
- To take pictures closer than 1m (3.3 ft.), use Macro Flash 1200AF Set or Close-up Flash Diffuser CD-1000 (available separately).

### ADDITIONAL SUGGESTIONS

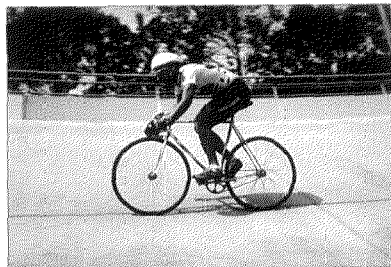

- When you attach the camera to a tripod, use the self-timer to take the picture. This will allow camera vibrations to subside before the shutter opens.

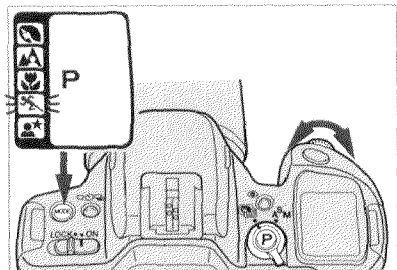

Fast action requires a fast shutter speed to stop the action. Sports mode enables you to concentrate entirely the action to capture the precise moment you want. The camera will automatically set the fastest shutter speed possible and continuously adjust focus to track fast-moving subjects.



### To select Sports mode:

1. Set the Command switch to .
2. Press and hold the Mode button and turn the control dial until  blinks.
3. Release the Mode button.

## RECOMMENDED LENSES

- Large-aperture lenses allow the camera to select faster shutter speeds.

## USING FLASH

- Use flash only if your subject is within flash range and the light is too dark to permit handheld photography (see p.59).

## ADDITIONAL SUGGESTIONS

- Fast film (ISO 400 or higher) enables the camera to set faster shutter speeds.
- Keep the focus frame centered over your subject.
- Select continuous-drive mode (see p.56) if needed.



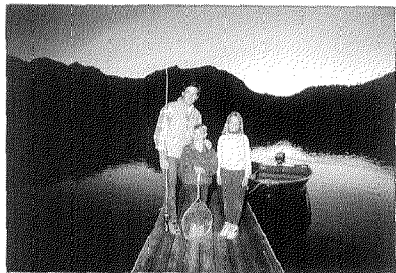

## NIGHT PORTRAIT

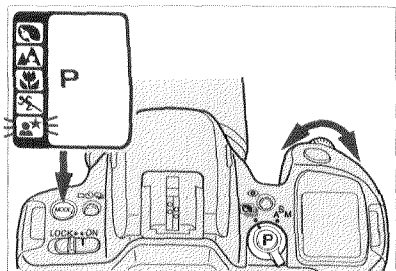

Use flash with Night Portrait mode to photograph people at night or at sunset. The camera will automatically balance the flash exposure with existing light. Also use Night Portrait mode without flash to photograph city skylines and other night scenes that are outside flash range.



### To select Night Portrait mode:

1. Set the Command switch to .
2. Press and hold the Mode button and turn the control dial until  blinks.
3. Release the Mode button.

## USING FLASH

- In Night Portrait mode, when the built-in flash is down or an attached accessory flash is off, the camera's flash signals will not appear in the viewfinder at any time.
- With flash, if the background is very dark, it may not appear in the photograph. This mode is best for photographing people at twilight or at night with lights in the background.

## ADDITIONAL SUGGESTIONS

- With or without flash, you should use a tripod for best results.
- If your subject is not near, such as a city skyline at night, autofocus may not be able to focus accurately. You may have to lock focus on a bright point (p.39) or focus manually (p.40).

# CREATIVE EXPOSURE SELECTION

When the Command switch is set to **A<sup>S</sup>M**, you can choose any of four separate exposure modes: Aperture-priority, Shutter-priority, Manual, and, of course, Program mode. While Subject Program mode allows you to match the camera to the photographic situation, Creative Exposure mode enables you to tailor the camera's operation to your vision of the end result and the degree of camera control you desire. For information on P mode, refer to "Full Auto Operation" beginning on page 17.

## A MODE: Aperture Priority

In A mode, you set the lens aperture manually and the camera selects the shutter speed which will provide a correct exposure.

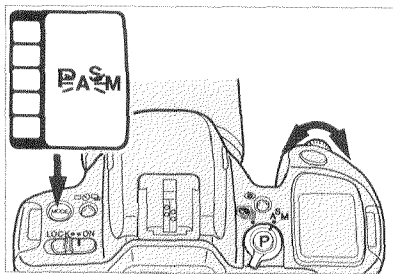

1. Set the Command switch to **A<sup>S</sup>M**.

2. Press and hold the Mode button and turn the control dial until A blinks.

3. Release the Mode button and turn the control dial to select the aperture you want.

- The aperture setting will change in 1/2-stop increments.

4. Compose your photograph, focus, and take the picture.



If 2000 or 30s blinks, the required setting is beyond the camera's shutter speed range. Turn the control dial until the blinking stops.

- See pp.59-60 for more exposure warnings.

## APERTURE CONTROL

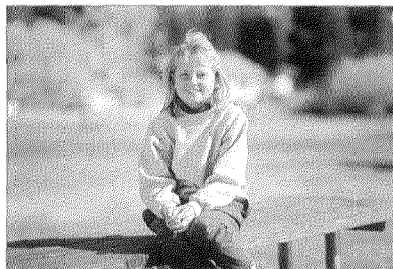

Large Aperture

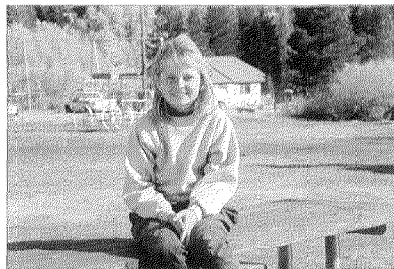

Small Aperture

The size of the aperture determines the intensity of the light falling on the film as well as the depth of field in the final image. Depth of field is the area in front of and behind the point on which the lens is focused which will also appear sharp in the final image.

Large apertures (small numbers) limit depth of field to a narrow range near the focus point. This is useful whenever you want to place greater visual emphasis on your main subject by intentionally blurring the background, such as in the case of portraits. Small apertures (large numbers) provide greater depth of field, bringing an increasingly greater range into focus. This is important when you are taking landscapes to ensure that your entire scene is sharp.

### LENS APERTURES

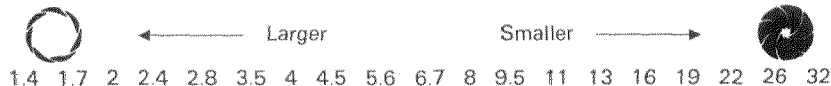

**NOTE:** Usable apertures will depend on the aperture range of the lens you are using.

In S mode, you set the shutter speed manually and the camera automatically selects the aperture which will provide the correct exposure.

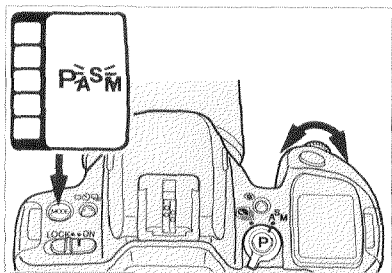

1. Set the Command switch to **A<sup>S</sup>M**.

2. Press and hold the Mode button and turn the control dial until S blinks.

3. Release the Mode button and turn the control dial to select the shutter speed you want.

- The shutter speed will change in 1-stop increments.
- You cannot select BULB in S mode.

4. Compose your photograph, focus, and take the picture.

If the aperture display blinks, the required setting is outside the lens' aperture range. Turn the control dial until the blinking stops.

- See pp.59-60 for more exposure warnings.





## M MODE: Manual Exposure

M mode gives you complete control over the exposure settings. In this mode, you select any shutter speed and aperture. The viewfinder data panel will tell you if the exposure you have selected is over, under, or the same as the camera's metered exposure.

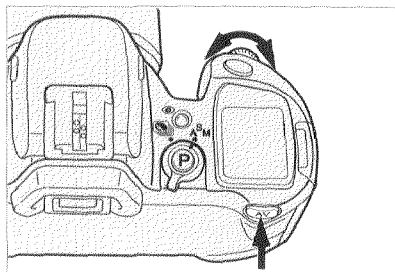
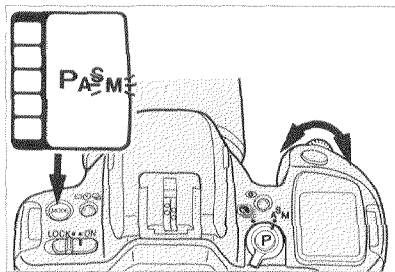

1. Set the Command switch to **A<sup>S</sup>M**.

2. Press and hold the Mode button and turn the control dial until M blinks.

3. Release the Mode button and turn the control dial to select the shutter speed you want.

4. While pressing the aperture button, turn the control dial to select the aperture you want.

5. Focus, check the viewfinder exposure indicators, and take the picture.

● The shutter speed will change in 1-stop increments and the aperture will change in 1/2-stop increments.

## VIEWFINDER INDICATORS



Correct exposure

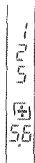

Over exposure

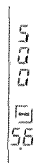

Under exposure

● See pp.59-60 for more exposure warnings.

Exposure is the quantity of light that reaches the film when you press the shutter-release button. This quantity is determined by the intensity of the light that falls on the film and the time that the film is exposed to light.

In M mode, you have full creative control over both of these variables: the aperture setting regulates the intensity of the exposure, and the shutter speed determines the time. By adjusting either of these in relation to the camera's metered exposure value, you can control the overall exposure of each image.



Over Exposure

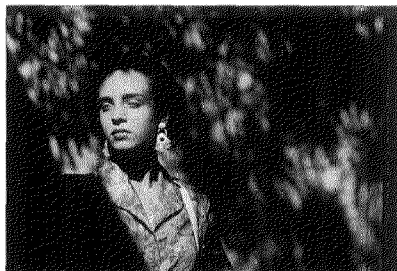

Under Exposure



Metered Exposure

When you select BULB, the shutter will remain open as long as you press the shutter-release button.

## To use BULB:

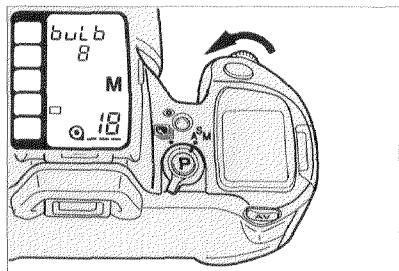

1. Attach your camera to a tripod.
2. Select M mode and turn the control dial to the left until BULB appears in the data panel.

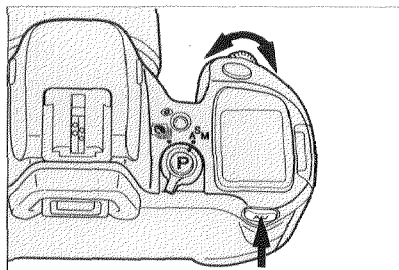

3. Set the aperture by pressing the aperture button and turning the control dial.
4. Compose your photograph and focus the lens.

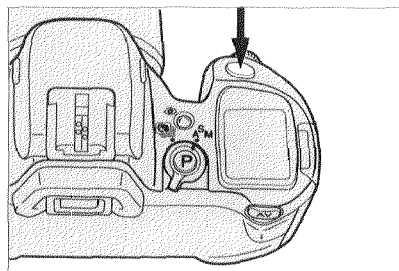

5. Attach the eyepiece cap (see p.8) to prevent light from entering the viewfinder during the exposure.
6. Press the shutter-release button to take the picture. The shutter will remain open as long as you hold the shutter-release down.