

DYNAX
600si Classic

MAXXUM[®]
600si
650si
PANORAMA DATE

QUICK
OPERATION

BASIC
OPERATION

FOCUS

EXPOSURE

FLASH

ADDITIONAL
FEATURES

APPENDIX



MINOLTA

Thank you for purchasing a Minolta camera and welcome to the wonderful world of SLR photography. This camera is equipped with functions which will suit your every photographic need. Before using your new camera, please take the time to read through this instruction manual for it contains important information on the use and care of your camera.

This manual contains information regarding products introduced before Jan., 1995. To obtain compatibility information for products introduced after this date, contact the authorized Minolta Service Facility nearest you.

TABLE OF CONTENTS

NAMES OF PARTS	2
QUICK OPERATION	6
BASIC OPERATION.....	8
Standard Accessories	9
Inserting the Battery	10
Checking the Battery Power	11
Attaching the Lens	12
Removing the Lens	13
Loading the Film.....	14
Rewinding the Film.....	16
Setting the Film Speed Manually	17
Camera Handling	18
In-Line Auto	19
Taking Pictures	20
FOCUS	22
Autofocus Modes	23
Autofocus Areas.....	26
Focus Signals.....	28
Focus Lock.....	29
Special Focusing Situations.....	31
Manual Focus.....	32
Autofocus Illuminator.....	33

EXPOSURE	34
Exposure Modes	35
Programmed Autoexposure Mode	37
Aperture-Priority Mode	38
Shutter-Priority Mode	40
Manual Exposure	42
Bulb	44
Metering Modes	45
Exposure Compensation	48
AE Lock	49
Multiple Exposure	52
Exposure Bracketing	54
FLASH	55
Using the Built-in Flash	56
Flash Signals	59
Using Flash in PROGRAM mode	60
Using Flash in A, S, and M Modes	61
Fill Flash	62
Slow-Shutter Sync	64
Flash Compensation	65
Flash Bracketing	66
Wireless/Remote Off-Camera Flash Control	68
ADDITIONAL FEATURES	73
For Owner's of the Quartz Data Model	74
Panorama Adapter	76
Self-Timer	78
Film-Drive Modes	79
Metering Index	80
Depth-of-Field Preview	82
Diopter Adjustment	83
APPENDIX	84
Accessory Information	85
Trouble Shooting	86
Technical Details	88
Care and Storage	90

NAMES OF PARTS

CAMERA BODY

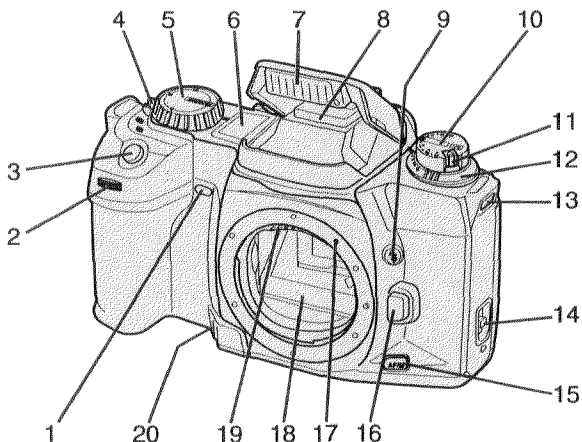

- | | |
|--|-----------------------------------|
| 1. Self-timer lamp | 12. Flash-compensation dial |
| 2. Front control dial | 13. Strap eyelet |
| 3. Shutter-release button | 14. Back-cover release |
| 4. Drive-mode selector | 15. AF/M focus-mode button |
| 5. Exposure-mode dial | 16. Lens release |
| 6. Body data panel | 17. Mounting index |
| 7. Built-in flash | 18. Mirror* |
| 8. Accessory shoe | 19. Lens contacts* |
| 9. Flash-control button | 20. Depth-of-field-preview button |
| 10. Exposure-compensation dial | |
| 11. Exposure-compensation lock release | |

*Do not touch

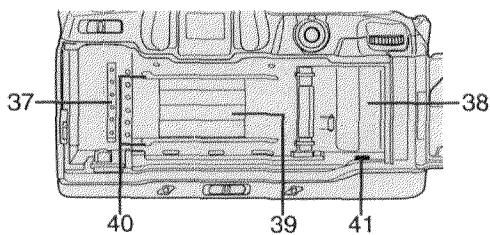
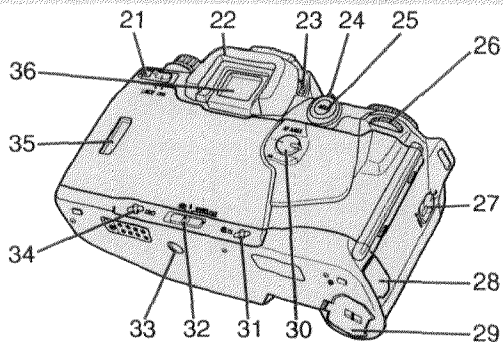

- | | |
|-----------------------------|-------------------------|
| 21. Main switch | 32. Flash-mode selector |
| 22. Eyepiece cup | 33. Tripod socket |
| 23. Diopter-adjustment dial | 34. ISO button |
| 24. Metering-mode selector | 35. Film window |
| 25. AE-lock button | 36. Eyepiece* |
| 26. Rear control dial | 37. DX contact* |
| 27. AF-mode selector | 38. Film chamber |
| 28. Remote-control terminal | 39. Shutter* |
| 29. Battery cover | 40. Film guide rails |
| 30. AF-area selector | 41. Film-leader index |
| 31. Rewind button | |

NAMES OF PARTS

BODY DATA PANEL

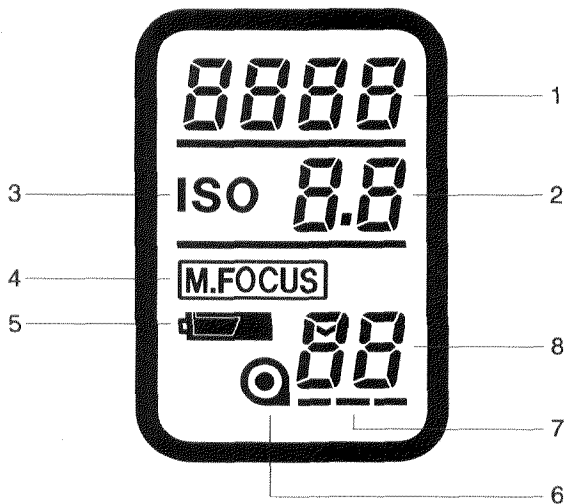

1. Shutter-speed/film-speed display
2. Aperture display
3. Film-speed mark
4. Manual-focus indicator

5. Battery-condition indicator
6. Film-cartridge mark
7. Film-transport signals
8. Frame counter

VIEWFINDER

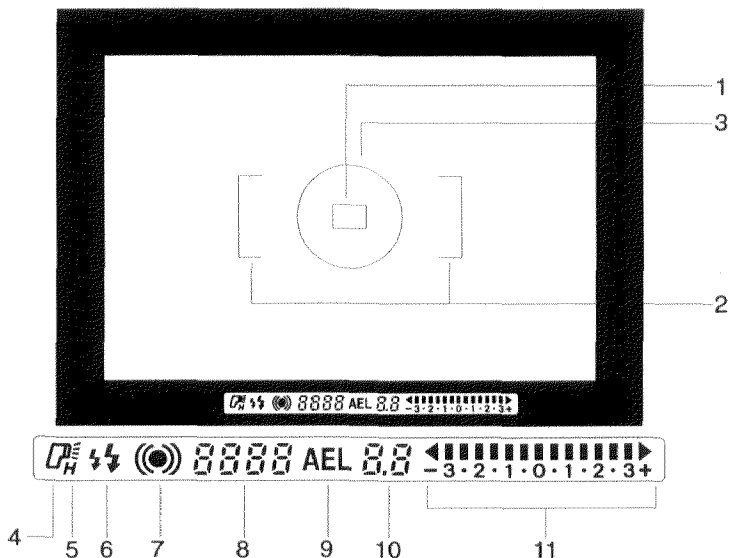

1. Spot focus area
2. Wide focus area
3. Spot-metering circle
4. Flash-on indicator
5. HSS indicator
6. Flash signals
7. Focus signals
8. Shutter-speed/film-speed display
9. AE-lock indicator
10. Aperture display
11. Metering index

Note: In this manual, glowing and blinking displays or indicators are identified as follows:



Glowing



Blinking

QUICK OPERATION

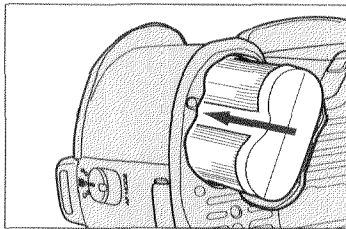

1. Insert battery

Insert one 6V 2CR5 lithium battery into the chamber as indicated by the + and - marks inside the battery chamber cover.

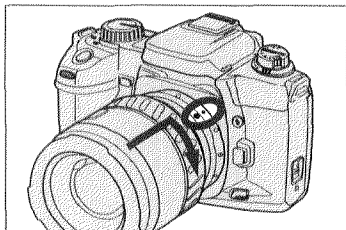

2. Attach lens

Align the red mounting index on the lens with the one on the camera. Gently insert the lens into the mount and turn it clockwise until it clicks.

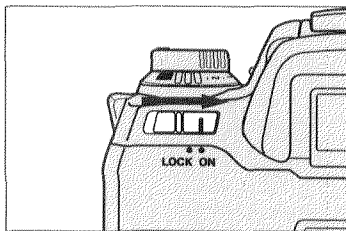

3. Turn on power

Slide the main switch to ON. Make sure the camera is set for full-automatic operation. See page 19.

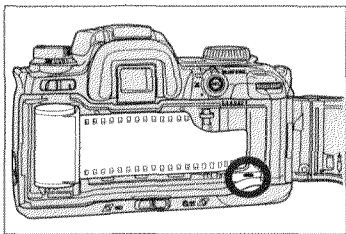

4. Load film

Insert the film and extend the film tip to the red film-leader index. Make sure the film is laying flat between the guide rails and close the back cover.

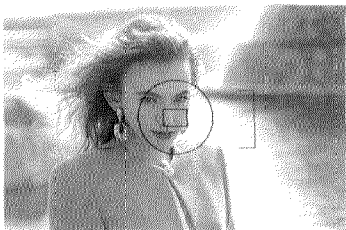

5. Focus on subject

Align your subject within the focus area and press the shutter-release button partway down to activate autofocus.

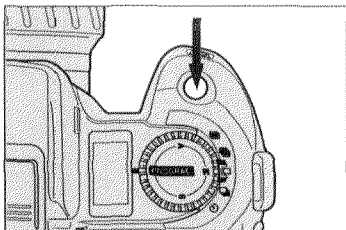

6. Take the picture

Gently press the shutter-release button all the way down to take the picture.

BASIC OPERATION

STANDARD ACCESSORIES

ATTACHING THE CAMERA STRAP

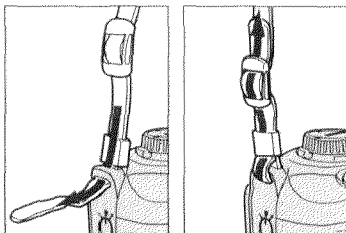

1. Undo the camera-strap buckle and loop the strap through the camera's strap eyelet.
2. Redo the camera-strap buckle.
3. Repeat for the other side.

ATTACHING THE EYEPIECE CUP

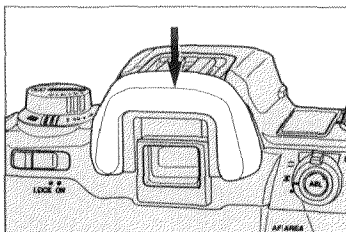

1. Align the eyepiece cup with the guide rails on the camera's eyepiece.
2. Push the eyepiece cup down until it clicks.

ATTACHING THE EYEPIECE CAP

When using the self-timer, bulb, or remote control, cover the eyepiece with the eyepiece cap which is attached to the camera's strap. This prevents stray light from entering the eyepiece and affecting the exposure.

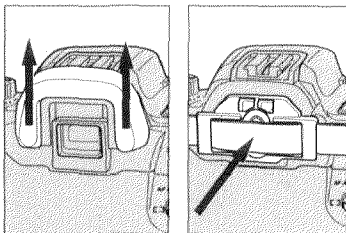

1. Remove the eyepiece cup.
2. Slide the eyepiece cap down over the camera's eyepiece.

INSERTING THE BATTERY

Your camera uses one 6-volt 2CR5 lithium battery which supplies power for all camera operations. Please read and follow all warnings in the Care and Storage section of this manual as well as warnings supplied by the battery manufacturer.

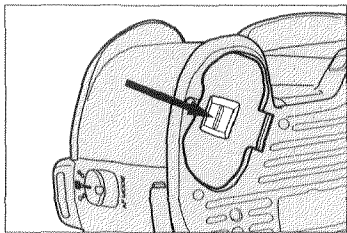

1. Open the battery chamber cover by pushing the battery-cover release in the direction of the arrow.

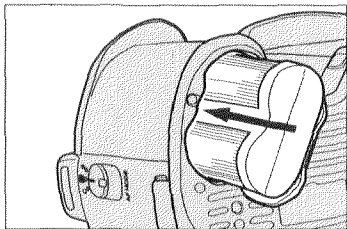

2. Insert the battery into the chamber as indicated by the + and - marks on the inside of the battery chamber cover and close the battery cover until it locks with a click.

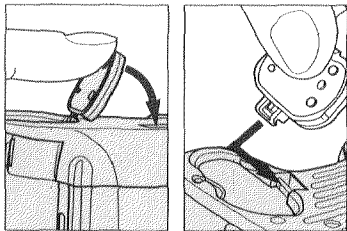

To attach the Vertical Control Grip VC-600 to your camera, you first have to remove the battery and battery cover. Open the battery cover and gently push it in the same direction until it detaches.

To reattach the battery cover, align the battery-cover hinge with the rod in battery chamber and gently push until it snaps on.

CHECKING THE BATTERY POWER

Your camera automatically checks battery power each time you slide the main switch to ON. One of the symbols below will appear in the body data panel indicating the power status of the battery. We recommend that you always carry a spare battery in your camera bag.

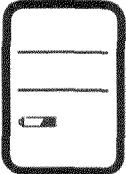
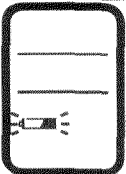
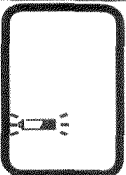
	Full-battery symbol — power is sufficient for all camera operations.
	Low-battery symbol — power is sufficient for all camera operations, but is getting low. Keep a new battery handy.
	Blinking low-battery symbol — power is extremely low, but all functions are operational. Flash recycling time may be slow. Battery will have to be replaced very soon.
	Blinking low-battery symbol appears alone and the shutter is locked — power is insufficient for camera operation. Replace the battery immediately.

- If no data appears in the data panel, replace the battery or check that it is inserted correctly.

ATTACHING THE LENS

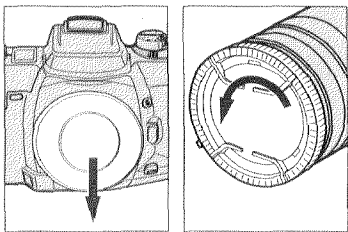

1. Remove the camera body cap and rear lens cap as shown.

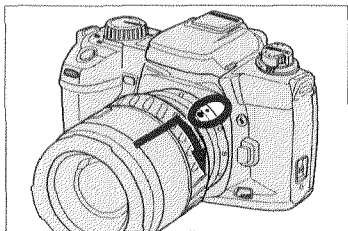

2. Align the red mounting index on the lens barrel with the one on the camera.
3. Gently insert the lens into the mount and turn it clockwise until it clicks into the locked position.

CAUTION

- Do not force the lens if it does not turn smoothly.
- Do not touch the inside of the camera, especially the lens contacts and mirror.

REMOVING THE LENS

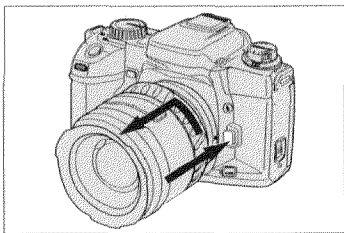

1. Press the lens release and hold it while turning the lens counter-clockwise until it stops.
2. Gently remove the lens from the mount.

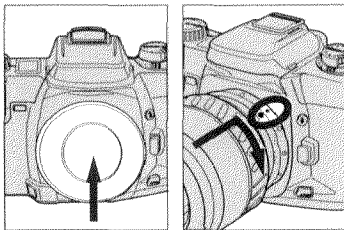

3. Replace the camera body cap or immediately attach another lens.

LOADING THE FILM

This camera is equipped with an automatic film transport system which automatically loads the film and advances the film after each exposure. Before you open the back cover, check the film window to make sure there is no film in the camera. Always load and unload the film in subdued light. We recommend that you use film between ISO 25 and 1000 for flash exposures.

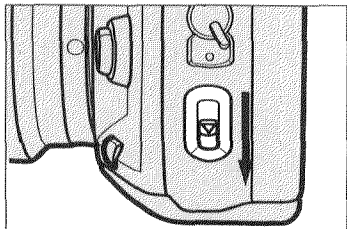

1. Slide the back-cover release down and open the back cover.
 - The slight mechanical sound you hear is normal camera operation.

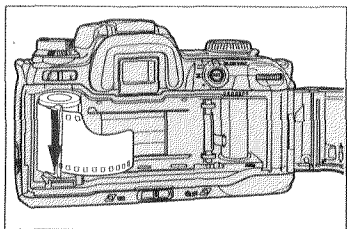

2. Place the film cartridge in the film chamber making sure that it is seated properly.

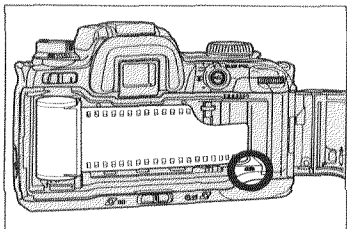

3. Extend the film tip to the red film-leader index making sure that it lays flat between the film guide rails.

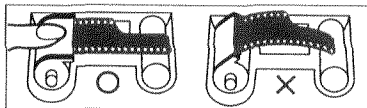

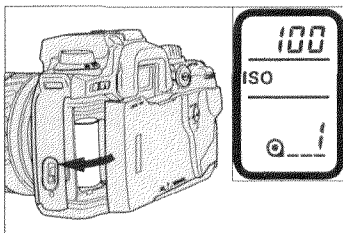

4. Close the back cover and slide the main switch to ON.

The film will automatically advance to the first frame and 1 will appear in the frame counter..

If you are using DX-coded film, the camera will automatically set the correct film speed and display it in the body data panel.

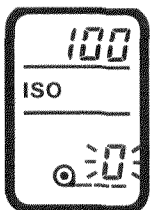

If the film has been loaded improperly, 0 will blink in the frame counter and the shutter will remain locked. Open the back cover and repeat the loading procedure.

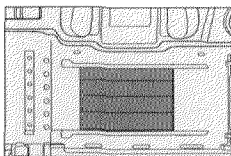

NEVER TOUCH THE SHUTTER CURTAIN WITH YOUR FINGERS OR FILM TIP. Its precision design makes it extremely sensitive to pressure.

Note:

- Do not use Polaroid instant 35mm films. Winding problems may occur.
- Non-DX-coded film will be set to the previous ISO setting.
- The camera will assume non-DX-coded film to be a 36 exposure roll.

Therefore, film rewind will begin automatically at the end of the roll or when the frame counter reaches 36.

REWINDING THE FILM

This camera will automatically rewind the film after the last frame has been exposed. If rewinding stops before the film has been completely rewound, **DO NOT OPEN THE BACK COVER**, insert a fresh battery and wait for rewinding to finish.

• 0 will appear in the frame counter and the film-cartridge mark will blink when the film is completely rewound.



REMOVING THE FILM

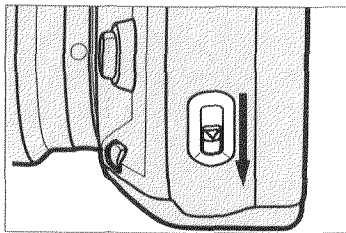

1. Wait for the film to rewind completely.
2. Open the back cover and remove the film.

MANUALLY STARTING FILM REWIND

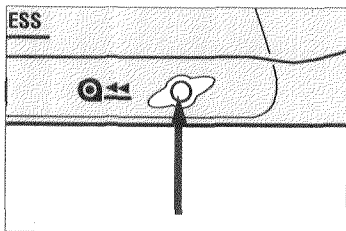

1. Slide the main switch to ON.
2. Gently press the rewind button.

Rewinding the Film at High-Speed

You can rewind the film faster by pressing the rewind button during film rewind, but the rewind sound will be slightly louder.

SETTING THE FILM SPEED MANUALLY

You can manually set the film speed when you are using non-DX-coded film or when you want to override the camera's automatic setting. Film speeds can be set manually from ISO 6 to 6400 in 1/3 EV increments.

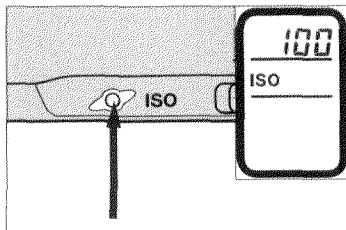

1. Press the ISO button.

The film-speed setting appears in the body data panel.

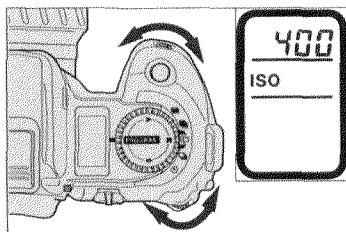

2. Turn either control dial to set the desired film speed.

3. Press the shutter-release button partway down to enter your selection.

CAMERA HANDLING

HOLDING THE CAMERA

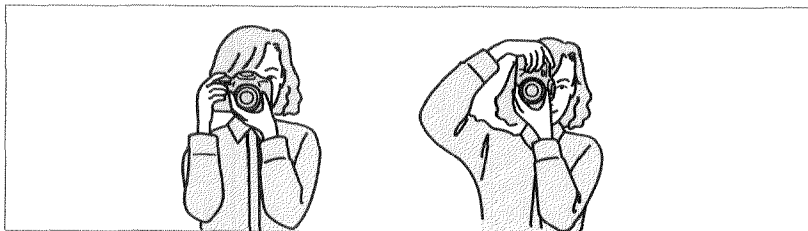

Hold the camera grip firmly with your right hand while supporting the camera or lens with your left hand. Make sure that your fingers are not blocking any of the camera's features; they should fit securely around the grip. To help keep the camera steady, stand with your legs slightly apart and keep your elbows at your side for support.

*Always keep the camera strap around your neck or wrist in the event that you accidentally drop it.

PRESSING THE SHUTTER-RELEASE BUTTON

The shutter-release button has three positions. To activate the camera's autofocus and autoexposure systems, press the shutter release button partway down. To take the picture, gently (never with a quick jab) press the shutter-release button all the way down.

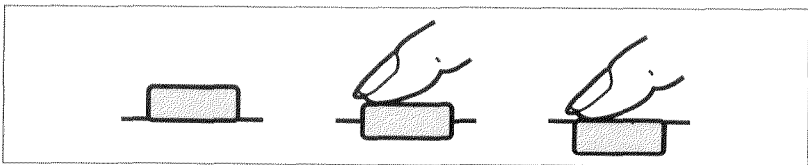

IN-LINE AUTO

In-Line Auto enables you to set the camera to full automatic operation. Position the controls on the top and side of the camera so that their indexes form a straight line. Position the controls on the back of the camera so that their indexes are aligned horizontally.

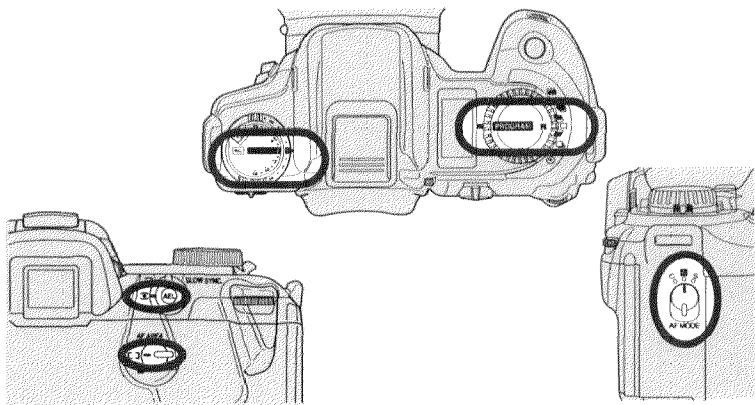

FUNCTION	IN-LINE AUTO SETTING
Exposure Compensation	0
Flash Compensation	0
Exposure Mode	PROGRAM
Drive Mode	<input type="checkbox"/> : Single-frame advance
AF Mode	A : Automatic AF-Mode Selection
Metering Mode	<input checked="" type="radio"/> : 14-Segment Honeycomb
AF Area	[<input type="checkbox"/>] : Wide

Note: For full-automatic operation, autofocus mode must be set. If M. Focus appears in the data panel, press the AF/M focus-mode button so that it disappears.

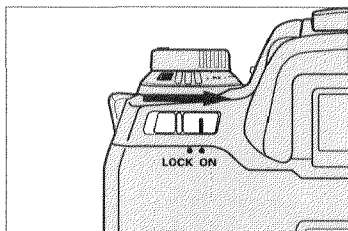

TAKING PICTURES IN FULL-AUTO MODE

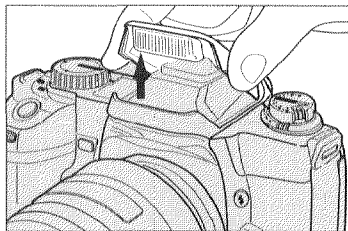

1. Set all camera functions to their automatic settings with In-Line Auto as described on the previous page and slide the main switch to ON.



2. Grip the built-in flash on both sides and gently lift. The flash will automatically fire when necessary.

• Make sure the flash-mode button is set to  or .

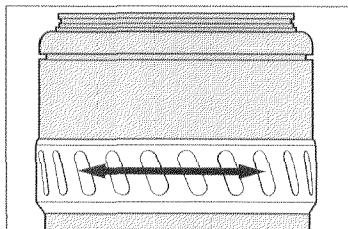

3. Rotate the zooming ring until your subject is framed as desired.

• If you are using an AF Zoom xi or AF Power Zoom lens, slide the lens' AZ/MZ switch to AZ.



4. Align the subject within the focus area and press the shutter-release button partway down to activate autofocus.

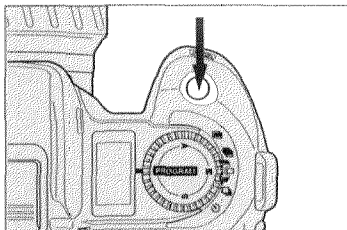

5. Gently press the shutter-release button all the way down to take the picture.

The film automatically advances to the next frame and the frame counter increases by one.

FOCUS

AUTOFOCUS MODES

This camera provides three autofocus modes: Automatic Autofocus-Mode Selection (A), Continuous Autofocus(C), and Single-Shot Autofocus (S).

AUTOMATIC AUTOFOCUS-MODE SELECTION (A)

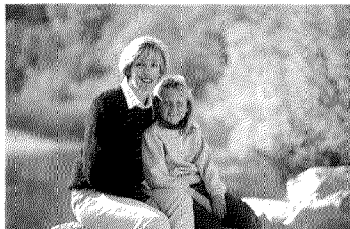

When you activate autofocus by pressing the shutter-release button partway down, the camera will continue focusing when the subject is moving and lock focus when it is still. *Automatic Autofocus-Mode Selection* works well in any situation, but is especially useful for subjects which move and stop suddenly.

AUTOFOCUS MODES

CONTINUOUS AUTOFOCUS (C)



The camera continues focusing as long as the shutter-release button is pressed partway down. The shutter-release button can be pressed all the way down to take the picture when the subject is in focus. Continuous Autofocus should be used when photographing sporting events or other occasions when you know the subject will be continuously moving.

SINGLE-SHOT AUTOFOCUS (S)

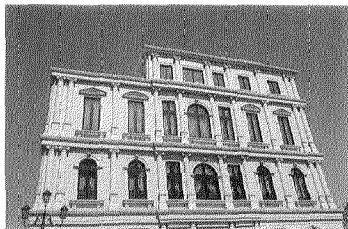

When you press the shutter-release button partway down in Single-Shot Autofocus mode the camera focuses until sharp focus is confirmed and then locks focus. Focus will remain locked as long as the shutter-release button is held partway down and the picture can be taken at any time. Single-Shot Autofocus should be used when you know your subject will remain still or when photographing subjects outside the focus area. See the Focus Lock section on page 29 for more information on photographing subjects outside the focus area.

SELECTING THE AUTOFOCUS MODE

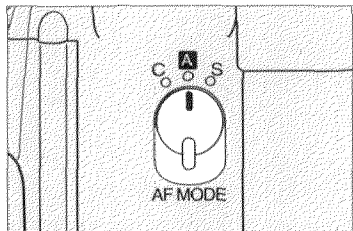

1. Set the AF mode selector to **A**, **C**, or **S**.

- Make sure the camera is set to autofocus mode; if **M.FOCUS** appears in the data panel, press the AF/M focus-mode button so that it disappears.

AUTOFOCUS AREAS

This camera has a wide focus area and a spot focus area. You can select either one and the camera will focus within that area.

WIDE FOCUS AREA

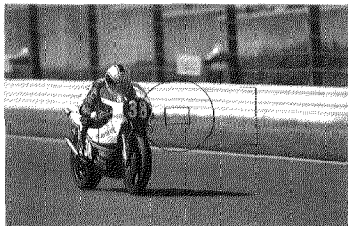

The camera uses all three of its autofocus sensors to focus. It can determine which sensor is focusing on the main subject even when there is more than one object within the focus area. Wide Focus Area provides flexibility in framing and makes it easier for the camera to focus on moving subjects.

SPOT FOCUS AREA



The camera uses only the center autofocus sensor to focus. Spot Focus Area is useful when you want to ensure focus on a specific area of the scene or subject.

SELECTING THE AUTOFOCUS AREA

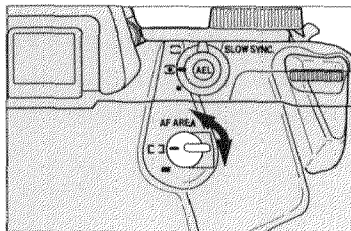

1. Set the AF-area selector to either [] (Wide focus area) or ■ (Spot focus area).

FOCUS SIGNALS

 250 5.6

Continuous focusing; focus confirmed

 250 5.6

Focus is confirmed and locked

 125 8

Focusing in autofocus mode; shutter locked

 500 4

Focus cannot be confirmed; shutter locked; subject too close or in one of the special focusing situations listed on page 31.