

## 17.7 Medication Guide

EXTAVIA (*ex tā vee uh*) Interferon beta-1b

Read the Medication Guide that comes with EXTAVIA before you start taking it and each time you get a refill. There may be new information. This Medication Guide does not take the place of talking with your doctor about your medical condition or your treatment.

### What is the most important information I should know about EXTAVIA?

EXTAVIA and other Interferon beta-1b medicines will not cure multiple sclerosis (MS) but have been shown to decrease the number of flare-ups of the disease. Interferon beta-1b medicines, including EXTAVIA, can cause serious side effects. Before you start to take EXTAVIA, you should talk to your doctor about the possible risks and benefits of EXTAVIA.

### Possible serious side effects with EXTAVIA include:

**Depression.** Some people who take interferon medicines, including EXTAVIA, become seriously depressed (feeling sad or sinking spirits). Some people have thoughts about killing themselves (suicidal thoughts) or try to kill themselves. Depression is not uncommon in people with multiple sclerosis.

- Before you start to take EXTAVIA, tell your doctor if you ever had any mental illness, including depression, or if you take any medicines for depression.
- While you take EXTAVIA, if you feel noticeably sadder or helpless, or feel like hurting yourself or others, you should tell a family member or friend right away and call your doctor as soon as possible. You may need to stop taking EXTAVIA.

**Risk to pregnancy.** If you become pregnant while you take EXTAVIA, stop taking EXTAVIA and call your doctor right away. Interferon beta-1b medicines, including EXTAVIA, may cause you to lose your pregnancy (miscarriage) or may cause harm to your unborn child. You and your doctor will need to decide whether the possible benefit of taking EXTAVIA is more important than the possible risks to your unborn child.

**Allergic reactions.** Some people who take Interferon beta-1b medicines, including EXTAVIA, have severe allergic reactions which can lead to trouble breathing and swallowing. Significant swelling of the mouth and tongue may occur with these severe allergic reactions. These reactions can happen quickly. Allergic reactions can happen after your first dose of EXTAVIA or may not happen until after you have taken EXTAVIA many times. Less severe allergic reactions such as rash, itching, skin bumps or minor swelling of the mouth and tongue can also happen. If you think you are having an allergic reaction, stop taking EXTAVIA right away and call your doctor.

**Injection site problems.** Interferon beta-1b medicines, including EXTAVIA, may cause redness, pain or swelling at the place where an injection was given (injection site). Serious skin reactions can happen in some people, including skin infections or areas of severe damage to skin and tissue below the skin (necrosis). These reactions can happen anywhere you inject EXTAVIA.

Call your doctor right away if you have any of these signs of a serious problem at any of your injection sites:

- the area is swollen and painful
- the area looks infected, and does not heal within a few days
- the area has fluid draining from it
- you notice any breaks in your skin or blue-black skin discoloration of your skin along with a break in your skin.

Most skin reactions are not serious, but you may need medical treatment if you develop a serious skin reaction. In most cases healing was associated with scarring.

If multiple lesions occur, therapy should be discontinued until healing occurs.

### What is EXTAVIA?

EXTAVIA is a man-made form of a protein called beta interferon. EXTAVIA is similar to certain interferon proteins that are produced in the body.

EXTAVIA is used to treat relapsing forms of multiple sclerosis (MS). It will not cure your MS but may decrease the number of flare-ups of the disease. MS is a life-long disease that affects your nervous system by destroying the protective covering (myelin) that surrounds your nerve fibers. The way EXTAVIA works in MS is not known.

## Who should not take EXTAVIA?

### Do not take EXTAVIA if you:

- have had an allergic reaction such as trouble breathing, skin flushing, or hives, with another interferon beta product, or to human albumin.
- are allergic to any of the ingredients in EXTAVIA. See the end of this Medication Guide for a list of the ingredients in EXTAVIA.

## What should I tell my doctor before taking EXTAVIA?

Tell your doctor about all your medical conditions, including if you have:

- or had depression, anxiety (feeling uneasy, nervous, or fearful), or trouble sleeping
- liver problems
- thyroid problems
- blood problems, such as bleeding or bruising easily, and low red blood cells (anemia) (or low white blood cells)
- are pregnant, breastfeeding, or planning to become pregnant. **See “What is the most important information I should know about EXTAVIA?”**
- are breastfeeding or plan to breastfeed. It is not known if EXTAVIA passes into your milk. You and your doctor should decide if you will breastfeed or take EXTAVIA. You should not do both without talking with your doctor.

Tell your doctor about all the medicines you take, including prescription and non-prescription medicines, vitamins, and herbal supplements.

Know the medicines you take. Keep a list of them and show it to your doctor and pharmacist when you get a new medicine.

## How should I take EXTAVIA?

- Take EXTAVIA exactly as prescribed by your doctor. Do not change your dose unless told to by your doctor.
- If your doctor decides that you or a caregiver may be able to give your injections of EXTAVIA at home, your doctor or nurse should instruct you on the right way to prepare and inject EXTAVIA. Do not try to inject EXTAVIA yourself until you have been instructed by your doctor or nurse the right way to prepare and give the injections.
- EXTAVIA is given by injection under the skin (subcutaneous injection) every other day.
- If you miss a dose of EXTAVIA, take your next dose as soon as you remember or are able to take it. Take your next injection about 2 days after that dose. If you are not sure when you should take your next dose, call your doctor.
- **Do not take EXTAVIA two days in a row (consecutive days).**
- Call your doctor right away if you take more than your prescribed dose of EXTAVIA, or take it two days in a row.
- **Always use a new, unopened, vial of EXTAVIA and syringe for each injection. Throw away any unused medicine. Do not reuse any vials, syringes, or needles.**
- It is important for you to change your injection site each time you inject EXTAVIA. This will lessen the chance of you having a serious skin reaction at the site where you inject EXTAVIA.
- Avoid injecting EXTAVIA into an area of skin that is sore, red, infected or has other problems.
- See the end of this Medication Guide for detailed Patient Instructions for Use for information about how to mix and inject EXTAVIA the right way.

## What are the possible side effects of EXTAVIA?

**EXTAVIA can cause serious side effects.** See “What is the most important information I should know about EXTAVIA?”.

### Common side effects of EXTAVIA include:

- **Flu-like symptoms.** Most people have flu-like symptoms (fever, chills, sweating, muscle aches and tiredness) when taking EXTAVIA. These symptoms may lessen or go away over time. Talk to your doctor about whether you should take a non-prescription medicine for pain, or to lower fever before or after you take your dose of EXTAVIA.
- **Liver problems.** EXTAVIA may affect your liver function. Your doctor will do blood tests to check for these problems while you take EXTAVIA. Tell your doctor if you have any of these symptoms of a liver problem:
  - yellowing of the skin and whites of the eyes
  - easy bruising
  - right-sided stomach area (abdominal) pain

- **Blood problems.** You may have a decrease in the amount of certain blood cells, including white blood cells (blood cells that fight infection), red blood cells (blood cells that carry oxygen to body tissues), or platelets (blood cells that help you form blood clots). If this decrease is severe, your body may be less able to fight infections, you may feel tired or sluggish, or you may bruise or bleed easily.
- **Thyroid problems.** Your thyroid function may change. Symptoms of changes in the function of your thyroid include feeling cold or hot much of the time, or change in your weight (gain or loss) without a change in your diet or amount of exercise you are getting.
- **Asthenia.** You may feel excessively or unusually fatigued. Talk to your doctor about your fatigue if it is persistent and bothersome to you.
- **Headache.** You may develop headaches. You should tell your doctor if you experience headaches while taking EXTAVIA, and you should make a plan with your doctor for monitoring your headaches. Talk to your doctor about whether you should take an additional medicine for the headaches.
- **Pain.** You may experience pain while taking EXTAVIA. Talk to your doctor about whether you should take a non-prescription medicine for pain and keep your doctor informed about any changes in the pain you experience.

You should discuss with your doctor the need for blood testing to monitor for these problems. Your doctor will arrange for testing your blood at regular intervals to help detect blood, thyroid, liver, or other problems that may develop. These blood tests will be needed even if you do not have any symptoms.

Tell your doctor if you have any side effect that bothers you or that does not go away. These are not all the possible side effects of EXTAVIA. For more information ask your doctor or pharmacist.

Call your doctor for medical advice about side effects. You may report side effects to FDA at 1-800-FDA-1088.

#### **How should I store EXTAVIA?**

- Before mixing, store EXTAVIA at room temperature 25°C (77°F). Storage at temperatures between 15° to 30°C (59° to 86°F) for brief periods of time are acceptable.
- After mixing, if you can not inject EXTAVIA right away, refrigerate the medicine and inject it **within 3 hours**. If you can not inject the mixed medicine within 3 hours, do not use it. Follow the information in the Patient Instructions for Use section “Dispose of used needles, syringes, and vials” for the right way to throw away the syringe with the unused medicine, and needle.
- Do not freeze EXTAVIA.

**Keep EXTAVIA and all medicines out of the reach of children.**

#### **General information about EXTAVIA**

Medicines are sometimes prescribed for purposes other than those listed in a Medication Guide. Do not use EXTAVIA for a condition for which it has not been prescribed. Do not give EXTAVIA to other people even if they have the same symptoms that you have. It may harm them.

This Medication Guide summarizes the most important information about EXTAVIA. If you would like more information, talk with your doctor. You can ask your doctor or pharmacist for information about EXTAVIA that is written for health professional. For more information go to the web site [www.EXTAVIA.com](http://www.EXTAVIA.com) or call the EXTAVIA toll-free medical information line at 1-888-669-6682.

#### **What are the ingredients in EXTAVIA?**

Active ingredient: interferon beta-1b

Inactive ingredients: mannitol, albumin (human).

The diluent contains sodium chloride solution.

#### **EXTAVIA Patient Instructions for Use**

If your doctor decides that you or a caregiver may be able to give your injections of EXTAVIA at home, your doctor or nurse should instruct you on the right way to prepare and inject EXTAVIA. To lower your risk of infection, it is important that you follow the technique that your doctor or nurse discussed with you to prepare and inject EXTAVIA. Do not try to inject EXTAVIA yourself until you have been shown by your doctor or nurse the right way to prepare and give the injections.

It is important for you to read, understand, and follow these instructions. Call your doctor if you or your caregiver has any questions about the right way to prepare or inject EXTAVIA.

### Important safety information

- Do not leave the blister pack containing EXTAVIA where others might tamper with it.
- **Keep the blister pack containing EXTAVIA out of the reach of children.**
- Do not open the blister pack or take out any of the items until right before you are ready to use them.
- Do not use EXTAVIA if the seal on the vial is broken. If the seal is broken, the product may not be safe for you to use.
- Do not use EXTAVIA after the expiration date shown on the blister pack label or box (Figure 1). If it has expired, return the entire pack to the pharmacy.

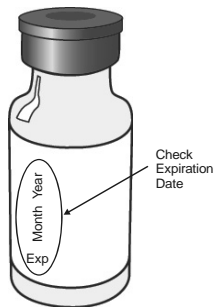

**Figure 1**

- Do not use any of the items in the blister pack more than one time. See the section at the end of this leaflet, “Dispose of used syringes, needles, and vials”. Throw away any open and unused medicine.

### Gather your supplies.

You will need the following supplies to get ready to give your injection of EXTAVIA:

- **A blister pack containing the following items (Figure 2)**
  - a vial of EXTAVIA
  - a prefilled syringe of diluent (Sodium Chloride, 0.54% solution)
  - a vial adapter with a 27-gauge needle attached (in its own container)
  - two (2) alcohol wipes

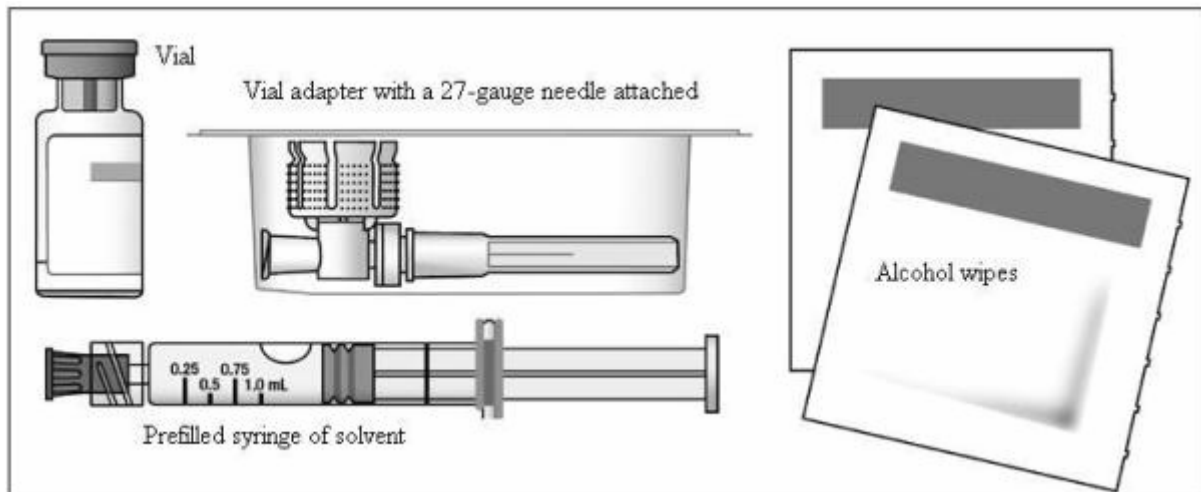

**Figure 2**

- a dry cotton ball and gauze
- a sharps disposal container (Figure 3). See the section “Dispose of used syringes, needles, and vials.”

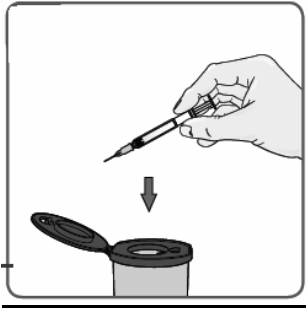

**Figure 3**

### **Prepare for self-injection**

1. Wash your hands well with soap and water.
2. Open the blister pack by peeling off the label and take out all the items. Make sure the blister pack containing the vial adapter is sealed. Check to make sure the rubber cap on the diluent syringe is firmly attached.
3. Turn the blister pack over, and place the vial in the well (vial holder) and place the prefilled syringe in the U-shaped trough (Figure 4).

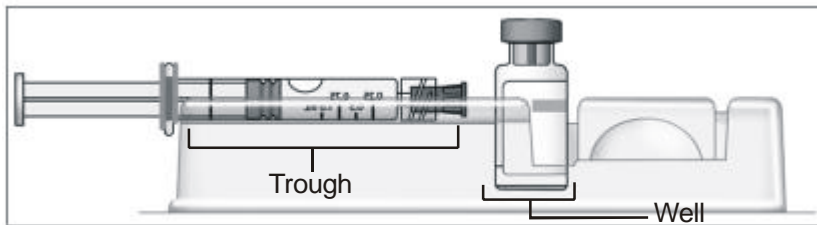

**Figure 4**

### **Mix EXTAVIA**

4. Remove the EXTAVIA vial from the well and take the cap off the vial (Figure 5).



**Figure 5**

5. Place the vial back in the vial holder.
6. Use an alcohol wipe to clean the top of the vial (Figure 6). Wipe in one direction only.



**Figure 6**

7. Leave the alcohol wipe on top of the vial until step 9 below.
8. Peel the label off the container with the vial adapter in it, but do not remove the vial adapter. The vial adapter is sterile, so do not touch it.
9. Remove the alcohol wipe from the top of the vial. Pick up the container that holds the vial adapter. Turn over the container keeping the vial adapter inside. Put the adapter on top of the vial. Push down on the adapter until it pierces the rubber top of the vial and snaps in place (Figure 7). Lift the container off the vial adapter.

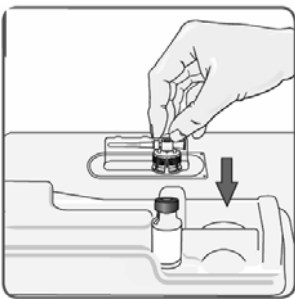

**Figure 7**

10. Remove the rubber cap from the prefilled syringe using a twist and pull motion (Figure 8). Throw away the rubber cap.

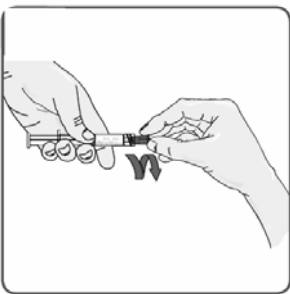

**Figure 8**

11. Remove the vial from the vial holder by grasping the vial. Do not touch any part of the vial adapter. Be careful not to pull the vial adapter off the top of the vial.
12. Connect the prefilled syringe of diluent to the vial adapter by turning clockwise and tighten carefully (Figure 9).

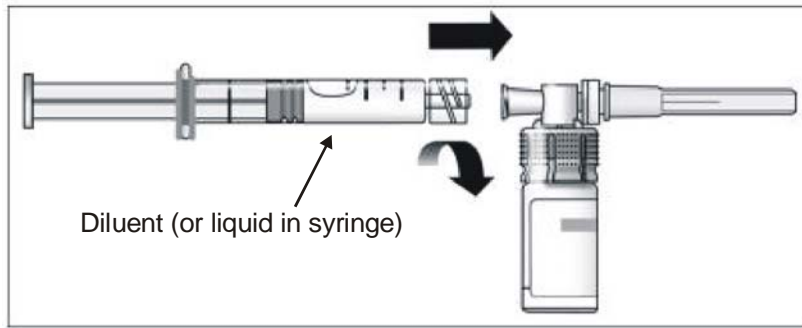

**Figure 9**

13. Slowly push the plunger of the prefilled syringe all the way in. This will push all of the liquid from the syringe into the vial (Figure 10). Continue to hold the plunger while you mix EXTAVIA with the liquid from the syringe. If you do not hold the plunger in it may return to its original position after you let go.

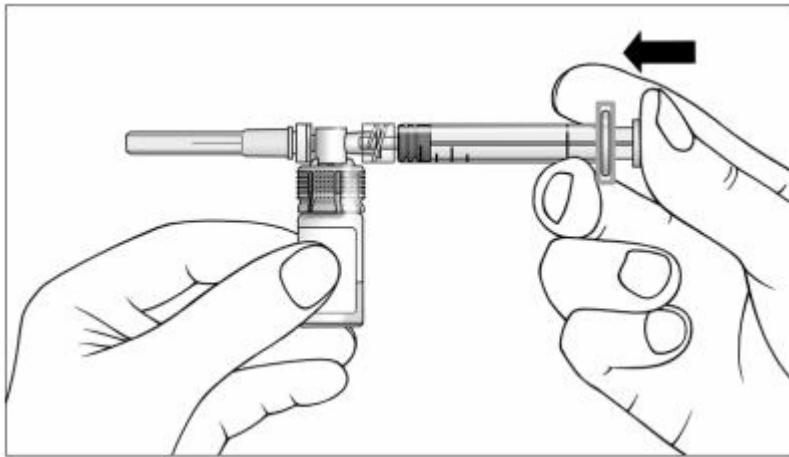
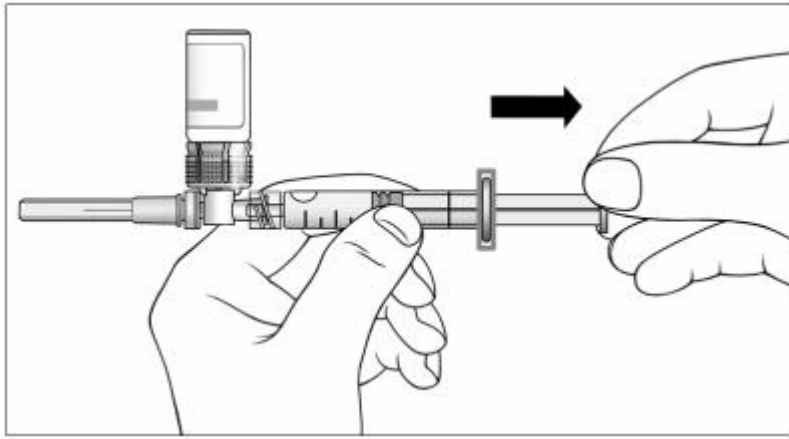

**Figure 10**

14. Gently swirl the vial to completely dissolve the white powder (EXTAVIA). **Do not shake.** Shaking and even gentle mixing can cause foaming of the medicine. If there is foam, let the vial sit until the foam settles.
15. After the powder dissolves, look closely at the solution in the vial. Do not use the solution if it is not clear or colorless, or if it contains particles.

**The injection should be given right away after you mix EXTAVIA and let any foam in the solution settle. If you must wait for any reason before giving yourself the injection, you may refrigerate the medicine after you mix it. But you should use it within three hours.**

16. With your thumb still pushing the plunger, turn the syringe and vial, so that the vial is on top (Figure 11).
17. Slowly pull the plunger back to withdraw the entire contents of the vial into the syringe.



**Figure 11**

18. Turn the syringe so that the needle end is pointing up. Remove any air bubbles by tapping the outside of the syringe with your fingers (Figure 12). Slowly push the plunger to the 1 mL mark on the syringe or to the mark that matches the amount of EXTAVIA prescribed by your doctor. If too much solution is pushed back into the vial, return to step 16.

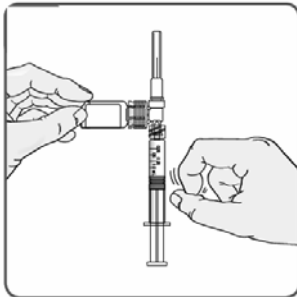

**Figure 12**

19. Remove the vial adapter and the vial from the syringe by twisting the vial adapter (Figure 13).

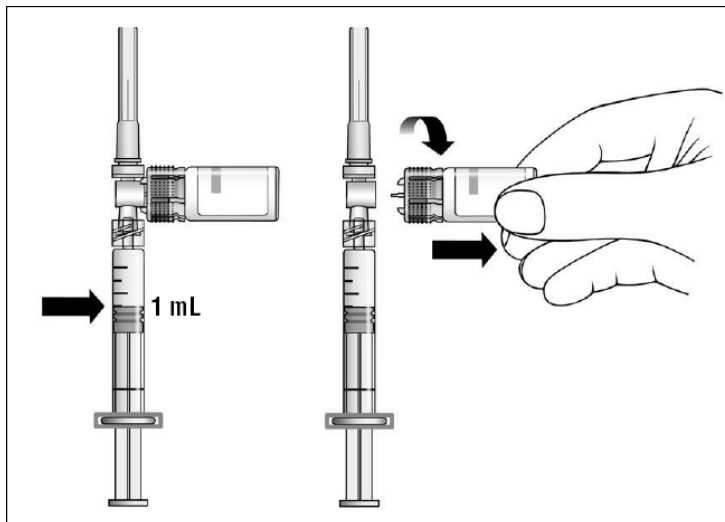

**Figure 13**

### Choose an Injection Site

- EXTAVIA is injected under the skin and into the fat layer between the skin and the muscles (subcutaneous tissue). The best areas for injection are where the skin is loose and soft and away from the joints, nerves, and bones. Do not



use the area near your navel (belly button) or waistline. If you are very thin, use only the thigh or outer surface of the arm for injection.

- Choose a different site each time you give yourself an injection. Figure 14 shows different areas for giving injections. Do not inject in the same area for two injections in a row. Keep a record of your injections to help make sure you change (rotate) your injection sites. If there are any sites that are difficult for you to reach, you can ask someone who has been trained to give the injection to you.

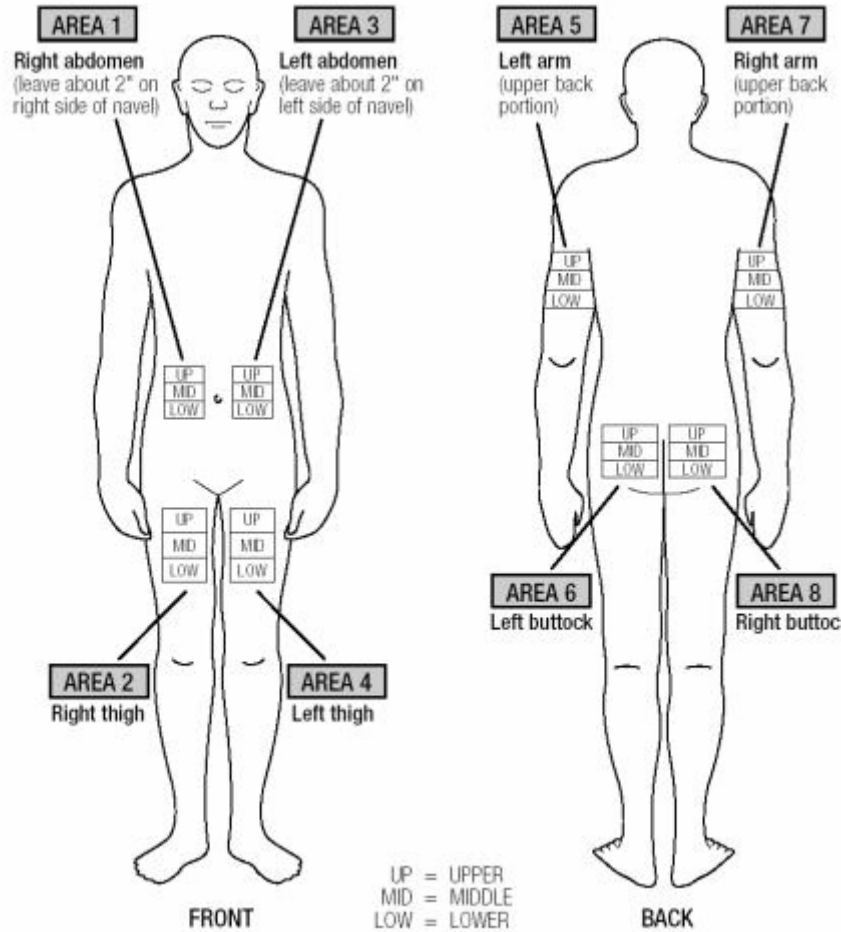
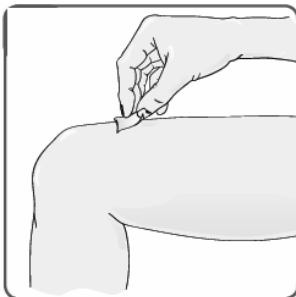

**Figure 14**

- Do not inject EXTAVIA in a site where the skin is red, bruised, infected, or scabbed, has broken open, or has lumps, bumps, or pain. Tell your doctor if you find skin conditions like the ones mentioned here or any other unusual looking areas where you have been given injections.

### **Injecting EXTAVIA**

- Using a circular motion, clean the injection site with an alcohol wipe, starting at the injection site and moving outward (Figure 15). Let the skin area air dry.



**Figure 15**

21. Remove the cap from the needle (Figure 16).

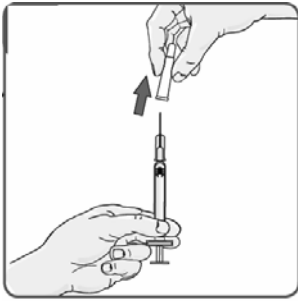

**Figure 16**

22. Gently pinch the skin around the site with your thumb and forefinger of the other hand (Figure 17). Insert the needle straight up and down into your skin at a 90° angle with a quick, dart-like motion.

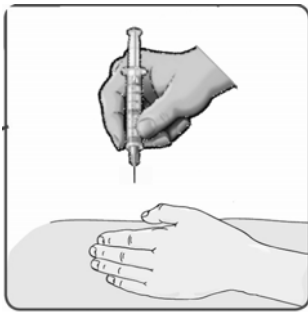

**Figure 17**

23. Once the needle is in your skin, slowly pull back on the plunger. If blood appears in the syringe it means that you have entered a blood vessel. Do not inject EXTAVIA. Withdraw the needle. Throw away the syringe and needle in your puncture-proof container. Do not use the same syringe or any of the other supplies that you used for this injection. Repeat the above steps to prepare your dose using a new blister pack. Choose and clean a new injection site.
24. If no blood appears in the syringe, slowly push the plunger all the way in until the syringe is empty (Figure 18). Remove the needle from the skin; then place a dry cotton ball or gauze pad over the injection site. Gently massage the injection site for a few minutes with the dry cotton ball or gauze pad. Throw away the syringe in your puncture-proof disposal container.

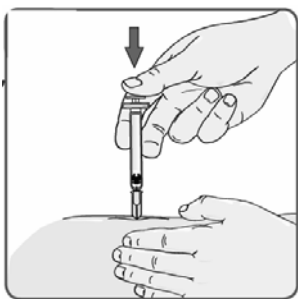

**Figure 18**

**Dispose of used syringes, needles, and vials**

- To prevent needle-stick injury and spread of infection, do not try to re-cap the needle.
- Place used needles, syringes, and vials in a closeable, puncture-resistant container. You may use a sharps container (such as a red biohazard container), a hard plastic container (such as a detergent bottle), or a metal container (such as an empty coffee can). Do not use glass or clear plastic containers. Ask your doctor for instructions on the right way to throw away (dispose of) the container. There may be state and local laws about how you should throw away used needles and syringes.
- **Do not throw used needles, syringes, or vials in your household trash or recycle.** Throw away any unused medicine. Do not save any unused EXTAVIA for a future dose.

**Keep the disposal container, needles, syringes, and vials of EXTAVIA out of the reach of children.**

REV.: AUGUST 2009

T2009-98

Manufactured by:

Distributed by:

Bayer HealthCare Pharmaceuticals Inc.

Novartis Pharmaceuticals Corporation

Montville, NJ 07045

East Hanover, NJ 07936

For

Novartis Pharmaceuticals Corporation

East Hanover, NJ 07936

U.S. License No. 1244

This Medication Guide has been approved by the U.S. Food and Drug Administration

T2009-97/T2009-98